

! Contact our sales office for delivery dates and prices as this is a special model.

Specialized Product **P.G.** Point to Group information

Fieldbus-compatible Vacuum Unit ZZK2-X198

Features

- Applicable to 6 types of communication networks

PROFI[®]
BUS

DeviceNet[™]

CC-Link

PROFI[®]
NET

EtherNet/IP[™]

EtherCAT[®]

- Applicable to input/output units

When connected to the input/output unit with a dedicated cable, output signals from switches with an energy saving function or digital pressure switches are sent to the communication network.

- Applicable to vacuum pump systems*1

(*1 Not applicable to switches with an energy saving function)

- Applicable to 4-station/8-station manifolds

Trademark

DeviceNet[™] is a trademark of ODVA.

EtherNet/IP[™] is a trademark of ODVA.

EtherCAT[®] is registered trademark and patented technology, licensed by Beckhoff Automation GmbH, Germany.

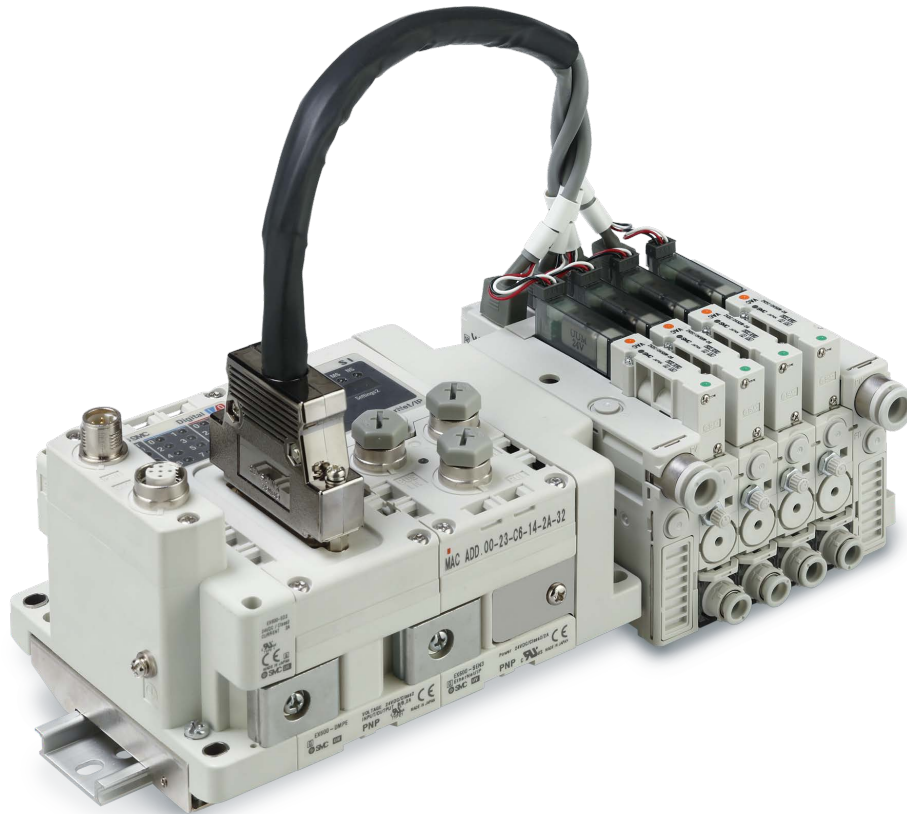

Caution

To ensure the safest possible operation of this product, please be sure to thoroughly read the "Safety Instructions" in our "Best Pneumatics" catalog before use.

SMC Corporation 4-14-1, SOTO-KANDA, CHIYODA-KU, TOKYO 101-0021, JAPAN URL: <http://www.smcworld.com>
©2018 SMC Corporation All Rights Reserved



SP177E-018E
P: WP

How to Order Manifold

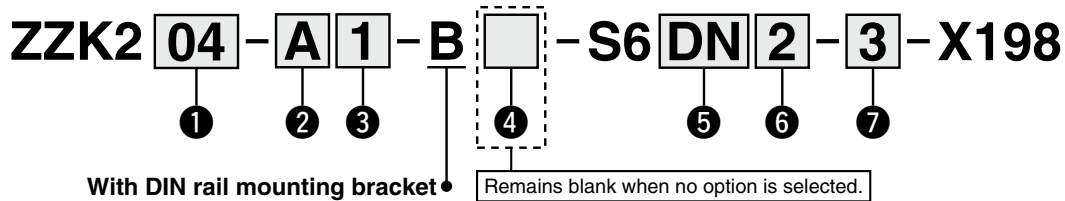

1 Stations*1

Symbol	Stations
04	4 stations
08	8 stations

*1 In the case of ejectors, for adequate performance, the number of stations that can be operated simultaneously depends on the nozzle diameter. (Refer to Maximum Number of Manifold Stations that can be Operated Simultaneously in the **Web Catalog**.)

4 Option*8

Symbol	Type
Nil	Without option
D	With common release pressure supply (PD) port*9
L	Manifold individual supply specification*10

*8 When more than one option is selected, list the option symbols in alphabetical order. Example) -DL

*9 When "-D" is selected for the manifold model number, select "-P" for 3 Optional Specifications for the ejector system single unit model number and 7 Optional Specifications for the vacuum pump system single unit model number. Refer to the **Web Catalog** for port layout.

*10 When "-L (individual supply)" is selected for 3 Optional Specifications for the single unit model number, specify "-L" for the manifold, too.

2 System (Port combination)*2

Symbol	System	Port	Standard
P	Vacuum pump system	Common PV: $\phi 8$, Common PS: $\phi 6$ *3	Metric size
A	Ejector system	Common PV: $\phi 8$ *4	
PN	Vacuum pump system	Common PV: $\phi 5/16"$, Common PS: $\phi 1/4"$ *3	Inch size
AN	Ejector system	Common PV: $\phi 5/16"$ *4	

*2 Refer to the **Web Catalog** for the port layout of standard port combinations and options.

*3 The common PS port and common PD port are connected inside. Connect a One-touch fitting to one of the ports to allow for easier piping. (Connected to PS port initially)

*4 Common PV = Common PS = Common PD The pressure is equal. (4 Without option)

5 Protocol

Symbol	Description
DN	DeviceNet™
PR	PROFIBUS DP
MJ	CC-Link
EN	EtherNet/IP™ (2 ports)
EC	EtherCAT®
PN	PROFINET

3 Exhaust

Symbol	Exhaust type
2	Vacuum pump system Without silencer
1	Ejector system Complex exhaust*7 (End plate on both sides)*5
2	

*5 Select "C" for 1 System/Body Type for the single unit model number. Air is exhausted not only from the end plate, but also from the exhaust of each station.

*6 Select "F" or "H" for 1 System/Body Type for the single unit model number.

*7 The complex exhaust is a combined exhaust method of the common exhaust from the end plate and the direct exhaust from each station.

6 Digital input/output unit: Input/output type

Symbol	Input/output type	Power supply with connector
2	NPN	M12
3		7/8 inch
4	PNP	M12
5		7/8 inch

7 Pressure switch specifications

Symbol	Type
1	Without digital pressure switch for vacuum
2	With digital pressure switch for vacuum
3	Digital pressure switch for vacuum with energy saving function

Manifold Type and Options

	1	2	3	4	
				D	L
ZZK2	04	P	2	●	
	08	PN			
		A	1	●	
		AN	2		●

How to Order Valve Manifold Assembly

Example

ZZK2C12K5KL3-08

ZZK208-A1-B-S6DN2-3-X198

ZZK208-A1-B-S6DN2-3-X198.....1 set (Manifold part number)
 * ZK2C12K5KL3-08.....8 sets
 * The asterisk denotes the symbol for the assembly.
 * Prefix to the single unit part number.

- When the manifold is viewed from V port, the first station starts from the left (D side).
- After the manifold part number, specify the installed single unit from the first station.
- Complex exhaust and individual port exhaust cannot be mixed in the ejector system manifold.

- PV: Air pressure supply port/Port for vacuum source (Vacuum pump)
 - PS: Pilot pressure supply port
 - PD: Individual release pressure supply port
 - V: Vacuum port
 - EXH: Exhaust port
 - PE: Pilot pressure exhaust port
- For details ⇒ **Web Catalog**

How to Order Single Unit

Ejector System

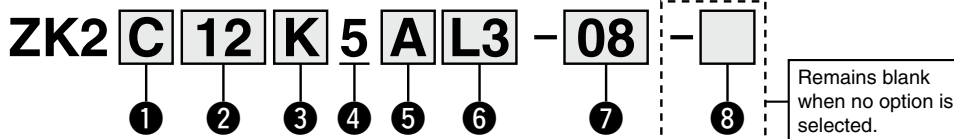

1 System/Body type

Symbol	System	Body type	Exhaust type
C	Ejector system	For manifold	Complex exhaust*1
F			Individual port exhaust*2
H			High-noise reduction silencer exhaust

- *1 The complex exhaust is a combined exhaust method of the common exhaust from the end plate and the direct exhaust from each station.
- *2 Individual port size of exhaust port: mm: $\phi 8$
inch: $\phi 5/16$

2 Nominal nozzle size

Symbol	System	Nominal size
07	Ejector system*3	$\phi 0.7$
10		$\phi 1.0$
12		$\phi 1.2$
15		$\phi 1.5$

- *3 Standard supply pressure for nozzle size 07 to 12 is 0.35 MPa, 15 is 0.4 MPa

3 Combination of supply valve and release valve*4

Symbol	Supply valve	Release valve
K *6	N.C.	N.C.
J	N.C.	None
R	Self-holding release valve linked*5	N.C.

- *4 Only non-locking type is available for the manual override for "K, J, R".
- *5 Self-holding type maintains vacuum by instantaneous energization (20 ms or more). Stopping the vacuum turns on the release valve. (signal to stop vacuum not needed)
- *6 When the digital pressure switch for vacuum with energy saving function is selected, select "K" for 5 Pressure Sensor/Digital Pressure Switch for Vacuum Specifications.

4 Rated voltage*7

Symbol	Voltage
5	24 VDC

- *7 Rated voltage for the supply and release valve

5 Digital pressure switch for vacuum specifications

Symbol	Type	Pressure range [kPa]	Specifications
A	Digital pressure switch for vacuum	0 to -101	NPN 2 outputs Unit selection function*8
B			SI unit only*9
C			Unit selection function*8
D		SI unit only*9	
E		-100 to 100	NPN 2 outputs Unit selection function*8
F			SI unit only*9
H	Unit selection function*8		
J	Digital pressure switch for vacuum with energy saving function*10	-100 to 100	PNP 2 outputs SI unit only*9
K			Unit selection function*8
Q			SI unit only*9
R			Unit selection function*8
S			SI unit only*9
N	Without pressure sensor/digital pressure switch for vacuum		

- *8 Unit selection function is not available in Japan due to new measurement law.
- *9 Fixed unit: kPa
- *10 When "K, Q, R, S" is selected, select "K" for 3 Combination of Supply Valve and Release Valve. Select "L3" for 6.

8 Optional specifications*12

Symbol	Type
Nil	Without option
B	With one bracket for mounting a single unit (Mounting screw is attached.)
D	With individual release pressure supply (PD) port*13
J	Vacuum break flow adjusting needle Round lock nut type
K	Vacuum break flow adjusting needle Screwdriver operation type
L	Manifold individual supply specification*14
P	Manifold common release pressure supply specification*15
W	With exhaust interference prevention valve*16*17*18*19

- *12 When more than one option is selected, list the option symbols in alphabetical order. Example) -BD Refer to the **Web Catalog** for Function/Application.
- *13 Only M3 is available for PD port size. Use One-touch fitting (M-3AU-4) or barb fitting for piping. (O.D.: within $\phi 6.2$)
- *14 Select body for manifold. Select "L" for manifold type. When the common supply and individual supply are mixed, please contact SMC.
- *15 When "D" is selected for manifold option, select "P" option for the single unit model number.
- *16 To prevent backflow of the manifold common exhaust, not for holding vacuum. This option does not completely stop the backflow of the exhaust air. Select port exhaust type depending on purpose.
- *17 When "J" is selected for 3 Combination of Supply Valve and Release Valve and "W" (with exhaust interference prevention valve) is selected for 8 Optional Specifications, install a release valve or vacuum breaker.
- *18 When "K, Q, R, S" is selected for 5 Digital Pressure Switch for Vacuum Specifications, models with exhaust interference prevention valve is provided. So, it is not necessary to select "W".
- *19 For high-noise reduction silencer exhaust, "W" (With exhaust interference prevention valve) cannot be selected.

6 Connector specifications

Symbol	Type
C1	Without digital pressure switch for vacuum
L3	With digital pressure switch for vacuum

7 Vacuum (V) port*11

Symbol	Type	Port size
06	Metric size	$\phi 6$ One-touch fitting
08		$\phi 8$ One-touch fitting
07	Inch size	$\phi 1/4$ " One-touch fitting
09		$\phi 5/16$ " One-touch fitting

- *11 Supply port (PV) size of single unit: $\phi 6$ (mm), $\phi 1/4$ " (inch)

Single Unit and Options*20

1	2	3	4	5	6	7	8
System/Body type	Nominal nozzle size	Combination of supply valve and release valve	Rated voltage	Digital pressure switch for vacuum specifications	Connector specifications	Vacuum (V) port	Optional specifications
C/F/H	07 10 12 15	K	5	A/B/C/D/E/F/H/J	L3	06 08 07 09	J/K/L/P/W
				N	C1		J/K/L/P
		K/Q/R/S		L3	J/K/L/P		
	R	A/B/C/D/E/F/H/J		L3	J/K/L/P/W		
		N		C1	J/K/L/P/W		
		A/B/C/D/E/F/H/J		L3	L/W		
				N	C1		

- *20 When "J" is selected for 3 Combination of Supply Valve and Release Valve, "J or K" cannot be selected for 8 Optional Specifications.

For options not in the table, please contact SMC.

* Refer to the **Web Catalog** when mounting a single unit onto the DIN rail.

- PV: Air pressure supply port/Port for vacuum source (Vacuum pump)
 - PS: Pilot pressure supply port
 - PD: Individual release pressure supply port
 - V: Vacuum port
 - EXH: Exhaust port
 - PE: Pilot pressure exhaust port
- For details ⇒ **Web Catalog**

How to Order Single Unit

Vacuum Pump System

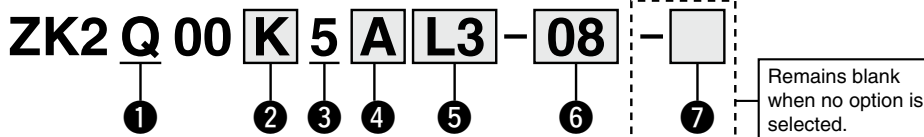

① System/Body type

Symbol	System	Body type
Q	Vacuum pump system	For manifold

* PS port size of pump system: mm: $\phi 4$
inch: $\phi 5/32$ "

③ Rated voltage*4

Symbol	Voltage
5	24 VDC

*4 Rated voltage for the supply and release valve

② Combination of supply valve and release valve*1

Symbol	Supply valve	Release valve
K	N.C.	N.C.
J	N.C.*2	None
R	Self-holding release valve linked*3	N.C.

*1 Only non-locking type is available for the manual override for "K, J, R".

*2 When "J" is selected for vacuum pump system, install a release valve or vacuum breaker.

*3 Self-holding type maintains vacuum by instantaneous energization (20 ms or more). Stopping the vacuum turns on the release valve. (signal to stop vacuum not needed)

⑤ Connector specifications

Symbol	Type
C1	Without digital pressure switch for vacuum
L3	With digital pressure switch for vacuum

⑥ Vacuum (V) port*7

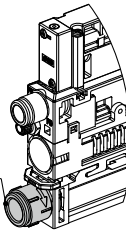
Symbol	Type	Port size	
06	Metric size	$\phi 6$	
08		One-touch fitting	
07	Inch size	$\phi 1/4$ "	
09		One-touch fitting	

*7 Supply port (PV) size of single unit: $\phi 6$ (mm), $\phi 1/4$ " (inch)

④ Pressure sensor/Digital pressure switch for vacuum specifications

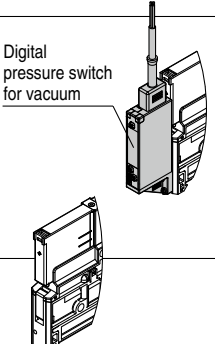
Symbol	Type	Pressure range [kPa]	Specifications	
A	Digital pressure switch for vacuum	0 to -101	NPN 2 outputs	
B			SI unit only*6	
C			Unit selection function*5	
D		PNP 2 outputs		
E		SI unit only*6		
F		Unit selection function*5		
H	-100 to 100	NPN 2 outputs		
J		SI unit only*6		
N	Without pressure sensor/digital pressure switch for vacuum			

*5 Unit selection function is not available in Japan due to new measurement law.

*6 Fixed unit: kPa

⑦ Optional specifications*8*12

Symbol	Type
Nil	Without option
B	With one bracket for mounting a single unit (Mounting screw is attached.)
C	Pump system PE port female thread specification (M3)*9
D	With individual release pressure supply (PD) port*10
J	Vacuum break flow adjusting needle Round lock nut type
K	Vacuum break flow adjusting needle Screwdriver operation type
P	Manifold common release pressure supply specification*11

*8 When more than one option is selected, list the option symbols in alphabetical order.
Example) -BC

*9 Use One-touch fitting (M-3AU-4) or barb fitting for piping. (O.D.: within $\phi 5.8$)

*10 Only M3 is available for PD port size. Use One-touch fitting (M-3AU-4) or barb fitting for piping. (O.D.: within $\phi 6.2$)

*11 When "D" is selected for manifold option, select "P" option for the single unit model number.

*12 Refer to the **Web Catalog** for Function/Application.

Single Unit and Options*13

① System/Body type	Vacuum pump system part number	② Combination of supply valve and release valve	③ Rated voltage	④ Pressure sensor/digital pressure switch for vacuum specifications	⑤ Connector specifications	⑥ Vacuum (V) port	⑦ Optional specifications
Q	00	K/R	5	A/B/C/D/E/F/H/J	L3	06	C/J/K/P
				N	C1	08	
		J		A/B/C/D/E/F/H/J	L3	07	C
				N	C1	09	

*13 When "J" is selected for ② Combination of Supply Valve and Release Valve, "J or K" cannot be selected for ⑦ Optional Specifications.

For options not in the table, please contact SMC.

* Refer to the **Web Catalog** when mounting a single unit onto the DIN rail.

Dimensions: Ejector System

ZZK2□-□-□-S6□- $\frac{2}{3}$ -X198/With digital pressure switch for vacuum
With digital pressure switch for vacuum with energy saving function

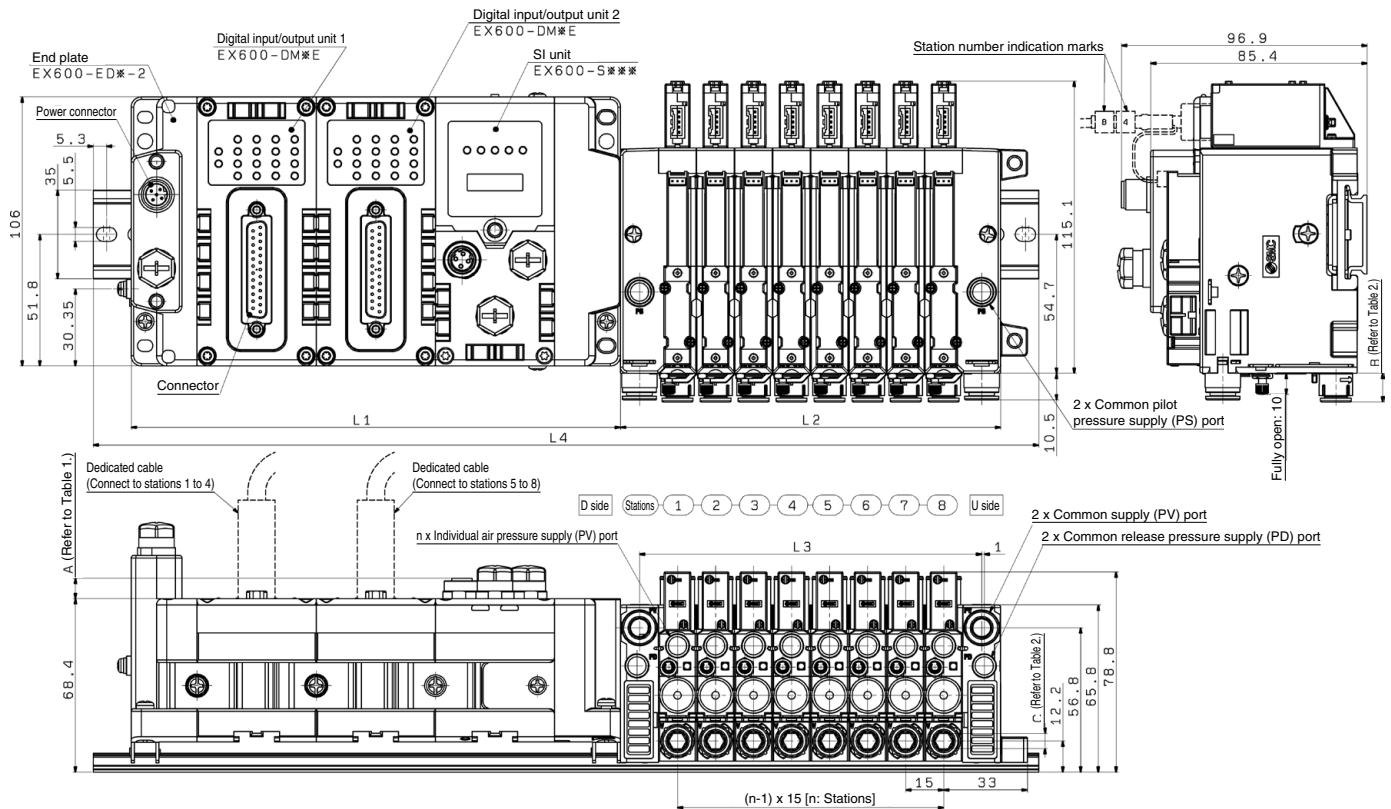

For high-noise reduction silencer exhaust
(Body type: H)

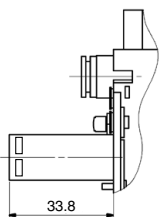

For port exhaust
(Body type: F)

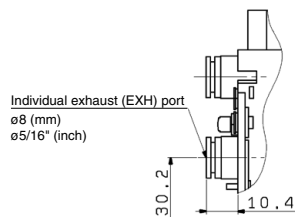

PD port dimensions
(Option symbol: -D)

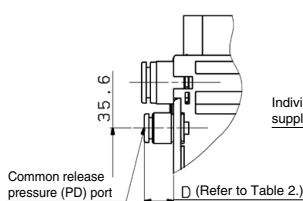

Individual (PV) port, PS port dimensions
(Option symbol: -L)

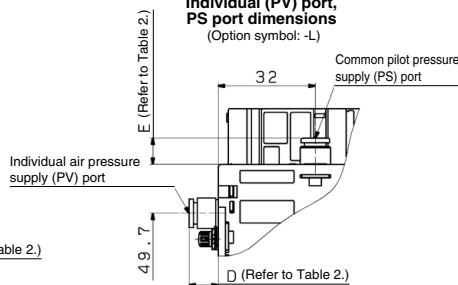

L Dimensions

Model	L ₁	L ₂	L ₃	L ₄
ZZK204-□-□-B□-S6□2-□-X198	146	90	75	260.5
ZZK204-□-□-B□-S6□4-□-X198				
ZZK204-□-□-B□-S6□3-□-X198	162.5	90	75	273
ZZK204-□-□-B□-S6□5-□-X198				
ZZK208-□-□-B□-S6□2-□-X198	193	150	135	373
ZZK208-□-□-B□-S6□4-□-X198				
ZZK208-□-□-B□-S6□3-□-X198	209.5	150	135	385.5
ZZK208-□-□-B□-S6□5-□-X198				

Table 1. SI Unit/A dimension

Protocol symbol	A
DN	11.5
PR	11.5
MJ	11.5
EN	8
EC	8
PN	8

Table 2. Port Dimensions

V port size		B	C	D	E
Metric size	06	ø6	8.3	4	9.7
	08	ø8	11.4	6	
Inch size	07	ø1/4"	10.8	4.76	12.3
	09	ø5/16"	11.4	6	

Dimensions: Vacuum Pump System

ZZK2□-□-□-□-**S6**□-**1**-X198/Without digital pressure switch for vacuum

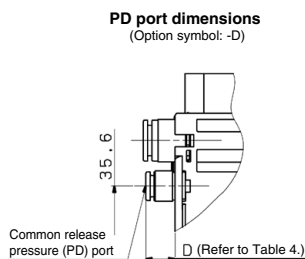
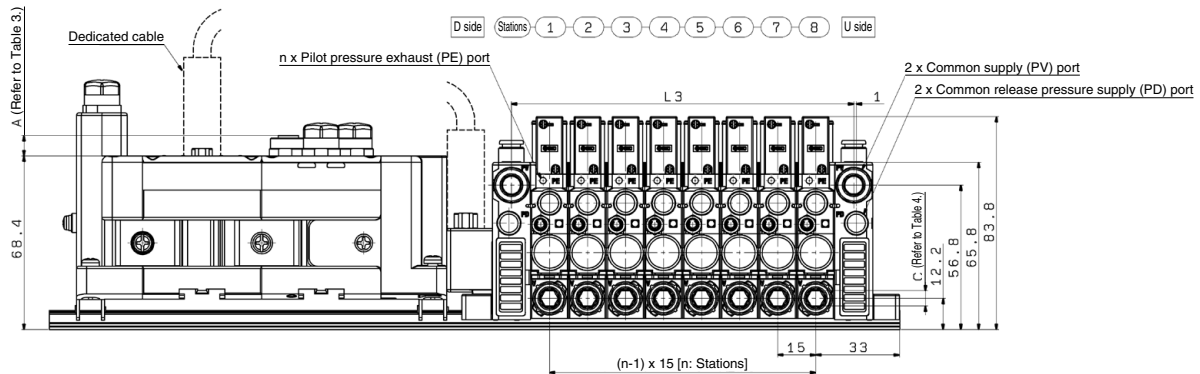
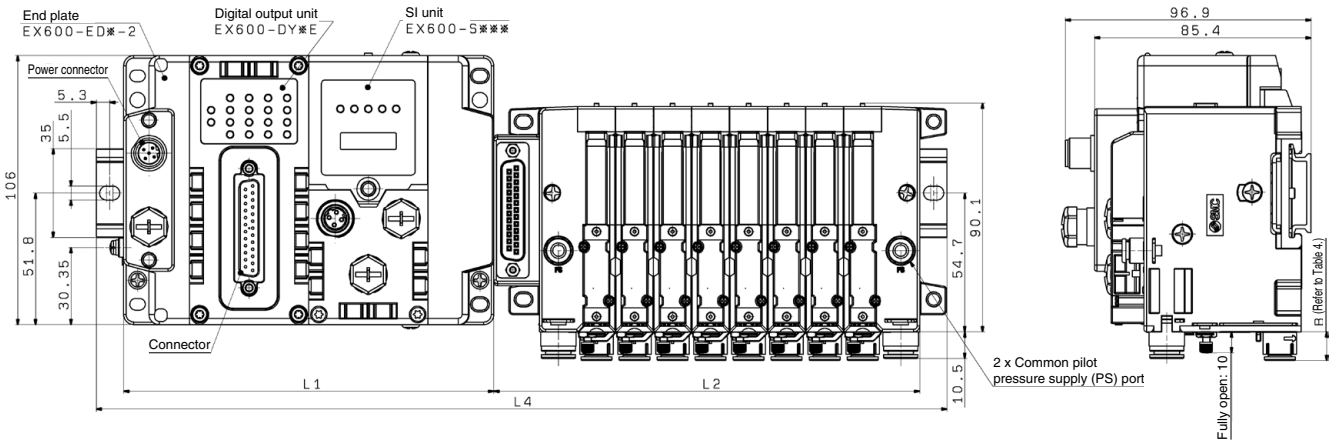

L Dimensions

Model	L ₁	L ₂	L ₃	L ₄
ZZK204-□-□-□- S6 □2-□- X198	146	108	75	273
ZZK204-□-□-□- S6 □4-□- X198	146	108	75	273
ZZK204-□-□-□- S6 □3-□- X198	162.5	108	75	298
ZZK204-□-□-□- S6 □5-□- X198	162.5	108	75	298
ZZK208-□-□-□- S6 □2-□- X198	146	168	135	335.5
ZZK208-□-□-□- S6 □4-□- X198	146	168	135	335.5
ZZK208-□-□-□- S6 □3-□- X198	162.5	168	135	360.5
ZZK208-□-□-□- S6 □5-□- X198	162.5	168	135	360.5

Table 3. SI Unit/A dimension

Protocol symbol	A
DN	11.5
PR	11.5
MJ	11.5
EN	8
EC	8
PN	8

Table 4. Port Dimensions [mm]

V port size		B	C	D
Metric size	06	ø6	8.3	4
	08	ø8	11.4	6
Inch size	07	ø1/4"	10.8	4.76
	09	ø5/16"	11.4	6

