

# 5 Port Solenoid Valve

## VQ7-6/7-8 Series

Metal Seal

Rubber Seal

ISO Standard Size 1/Size 2



SV
SYJ
SZ
VF
VP4
VQ 1/2
VQ 4/5
VQC 1/2
VQC 4/5
VQZ
SQ
VFS
VFR
VQ7

VQ7-6/Single unit

P.1118



Conforms to ISO standard 5599/I  
Interface conforms to ISO standard  
Size 1 (VQ7-6) and Size 2 (VQ7-8).

Outstanding high speed response  
and long service life

VQ7-6/Manifold

P.1123

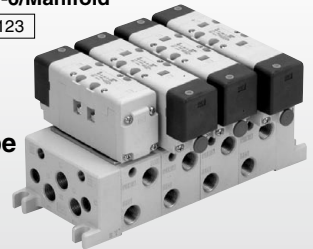

Enclosure IP65 compliant  
Dusttight/Low jetproof type

VQ7-8/Single unit

P.1134

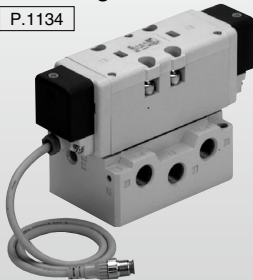

A wide variety of manifold options  
Manifolds can be configured with a wide range of interface  
options to meet a variety of application requirements.

VQ7-8/Manifold

P.1139

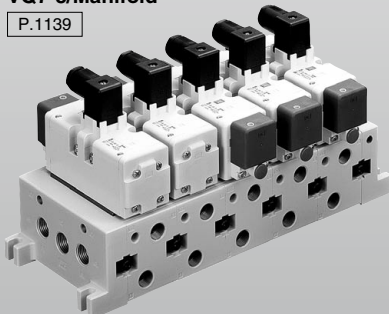

### Lighter weight

Size 1 (3 position) 0.48 kg ...24% less (Compared with previous series)  
Size 2 (3 position) 0.75 kg ...15% less

### Space-saving profile

Installation space.....13% reduction  
Installation volume.....10% reduction  
(Compared with previous series)

Choice of metal or rubber seal increases  
compatibility with various operating and  
environmental conditions.

# Cylinder Speed Chart

Use as a guide for selection.  
Please confirm the actual conditions with SMC Sizing Program.

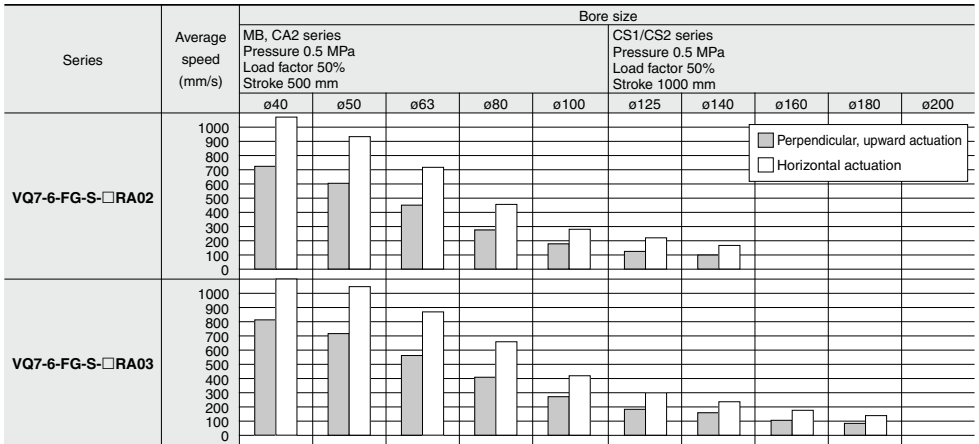
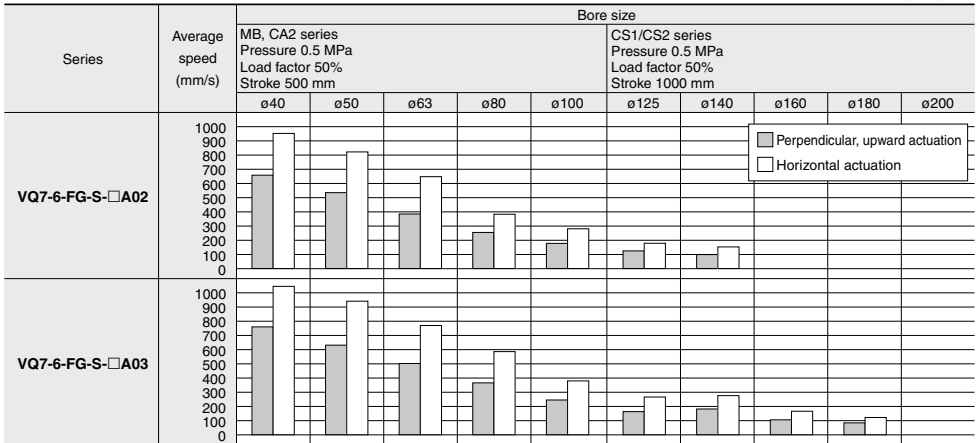

- \* It is when the cylinder is extending that is meter-out controlled by speed controller which is directly connected with cylinder, and its needle valve with being fully open.
- \* The average velocity of the cylinder is what the stroke is divided by the total stroke time.
- \* Load factor: ((Load mass x 9.8)/Theoretical force) x 100%

# Cylinder Speed Chart

Use as a guide for selection.  
Please confirm the actual conditions with SMC Sizing Program.

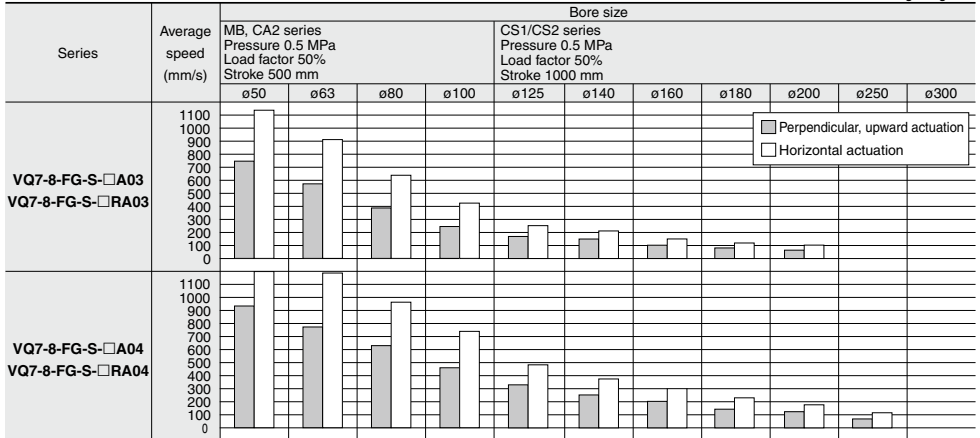

- \* It is when the cylinder is extending that is meter-out controlled by speed controller which is directly connected with cylinder, and its needle valve with being fully open.
- \* The average velocity of the cylinder is what the stroke is divided by the total stroke time.
- \* Load factor: ((Load mass x 9.8)/Theoretical force) x 100%

## Conditions

	Base mounted	
	MB, CA2 series	CS1/CS2 series
VQ7-6-FG-S-□A02	SGP (Steel pipe) dia. x Length	6A x 1 m
	Speed controller	AS4000-02
	Silencer	AN20-02
VQ7-6-FG-S-□A03	SGP (Steel pipe) dia. x Length	10A x 1 m
	Speed controller	AS420-03
	Silencer	AN30-03
VQ7-6-FG-S-□RA02	SGP (Steel pipe) dia. x Length	6A x 1 m
	Speed controller	AS4000-02
	Silencer	AN20-02
VQ7-6-FG-S-□RA03	SGP (Steel pipe) dia. x Length	10A x 1 m
	Speed controller	AS420-03
	Silencer	AN30-03

	Base mounted	
	MB, CA2 series	CS1/CS2 series
VQ7-8-FG-S-□A03	SGP (Steel pipe) dia. x Length	10A x 1 m
	Speed controller	AS4000-03
	Silencer	AN30-03
VQ7-8-FG-S-□A04	SGP (Steel pipe) dia. x Length	15A x 1 m
	Speed controller	AS420-04
	Silencer	AN40-04
VQ7-8-FG-S-□RA03	SGP (Steel pipe) dia. x Length	10A x 1 m
	Speed controller	AS4000-03
	Silencer	AN30-03
VQ7-8-FG-S-□RA04	SGP (Steel pipe) dia. x Length	15A x 1 m
	Speed controller	AS420-04
	Silencer	AN40-04

SV

SYJ

SZ

VF

VP4

VQ 1/2

VQ 4/5

VQC 1/2

VQC 4/5

VQZ

SQ

VFS

VFR

VQ7

# ISO Standard Solenoid Valve

# VQ7-6 Series

## Size 1/Single Unit



### How to Order Valves

VQ7-6 - **FG** - **S** - **3** [ ] [ ] [ ] [ ] [ ] [ ] [ ] [ ] [ ]

**Passage symbol**

<b>FG</b>	
<b>YZ*</b>	
<b>FHG</b>	
<b>FJG</b>	
<b>FIG</b>	

\* Semi-standard

**Number of solenoids**

<b>S</b>	Single
<b>D</b>	Double

**CE-compliant**

<b>Nil</b>	—
<b>Q</b>	CE-compliant

**Connector**

<b>Nil</b>	DIN terminal block (With connector)
<b>O</b>	DIN terminal block (Without connector)
<b>SC</b>	Pre-wired connector

**Sub-plate port size**

<b>Nil</b>	Without sub-plate
<b>A02</b>	Side ported 1/4"
<b>A03</b>	Side ported 3/8"
<b>B02</b>	Bottom ported 1/4"
<b>B03</b>	Bottom ported 3/8"

\* Port R is 3/8"

**Thread type**

<b>Nil</b>	Rc
<b>F</b>	G
<b>T</b>	NPTF

**Seal**

<b>Nil</b>	Metal seal
<b>R</b>	Rubber seal

**Pilot exhaust**

<b>Nil</b>	Common exhaust
<b>V</b>	Individual exhaust

**Option**

<b>Nil</b>	None
<b>Z</b>	Light/Surge voltage suppressor
<b>N</b>	With indicator light

**Coil rated**

<b>1</b>	100 VAC, 50/60Hz
<b>2</b>	200 VAC, 50/60Hz
<b>3</b>	24 VDC
<b>4</b>	12 VDC
<b>5</b>	110 VAC, 50/60Hz
<b>6</b>	220 VAC, 50/60Hz

For other rated voltages, please consult with SMC.

### How to Order Sub-plate

VS7-1 - **A02** [ ] [ ]

**Port size**

<b>A02</b>	Side ported 1/4"
<b>A03</b>	Side ported 3/8"
<b>B02</b>	Bottom ported 1/4"
<b>B03</b>	Bottom ported 3/8"

\* Port 3(R2) and 5(R1) are 3/8"

**Thread type**

<b>Nil</b>	Rc
<b>F</b>	G
<b>T</b>	NPTF

#### Specifications

Model	Piping location	Porting specifications		Weight (kg)
		1(P), 2(B), 4(A) port size	3(R2), 5(R1) port size	
VS7-1-A02□	Side	1/4	3/8	0.37
VS7-1-A03□		3/8		
VS7-1-B02□	Bottom	1/4	3/8	
VS7-1-B03□		3/8		

**Model**

Series	Number of positions	Model		Port size	Flow rate characteristics						Response time (ms) <sup>(1)</sup>	Weight (kg) <sup>(2)</sup>		
					1 → 4/2 (P → A/B)			4/2 → 5/3 (A/B → EA/EB)						
					C (dm <sup>3</sup> /s/bar)	b	Cv	C (dm <sup>3</sup> /s/bar)	b	Cv				
VQ7-6	2 position	Single	Metal seal	VQ7-6-FG-S-□	1/4	4.1	0.10	0.9	5.2	0.10	1.1	20 or less	0.40	
			Rubber seal	VQ7-6-FG-S-□R		5.0	0.13	1.1	6.0	0.11	1.4	25 or less		
		Double	Metal seal	VQ7-6-FG-D-□		4.1	0.10	0.9	5.2	0.10	1.1	12 or less		0.45
			Rubber seal	VQ7-6-FG-D-□R		5.0	0.13	1.1	6.0	0.11	1.4	15 or less		
	3 position	Closed center	Metal seal	VQ7-6-FHG-D-□		4.1	0.10	0.9	5.2	0.10	1.1	40 or less	0.48	
			Rubber seal	VQ7-6-FHG-D-□R		5.0	0.13	1.1	5.6	0.20	1.3	45 or less		
		Exhaust center	Metal seal	VQ7-6-FJG-D-□		4.1	0.10	0.9	5.2	0.10	1.1	40 or less	0.48	
			Rubber seal	VQ7-6-FJG-D-□R		4.8	0.16	1.1	6.0	0.17	1.4	45 or less		
		Double check	Metal seal	VQ7-6-FPG-D-□		1.4	—	—	3.1	—	—	50 or less	0.84	
			Rubber seal	VQ7-6-FPG-D-□R		1.4	—	—	3.1	—	—	50 or less		
		Pressure center	Metal seal	VQ7-6-FIG-D-□		4.1	0.10	0.9	5.2	0.08	1.1	40 or less	0.48	
			Rubber seal	VQ7-6-FIG-D-□R		5.6	0.15	1.2	5.9	0.08	1.3	45 or less		

Note 1) Based on JIS B 8419: 2010 (Value for supply pressure of 0.5 MPa, with light/surge voltage suppressor, when using clean air.)  
Response time values will change depending on pressure and air quality.  
Value when ON for double type.

Note 2) Weight without sub-plate. (Sub-plate: 0.37 kg)

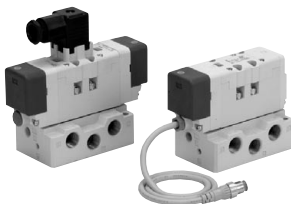

**Symbol**

2 position single

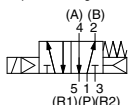

2 position double (Metal)

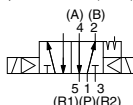

2 position double (Rubber)

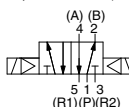

3 position closed center

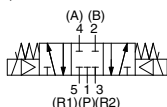

3 position exhaust center

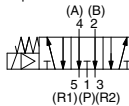

3 position double check

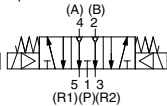

3 position pressure center

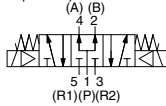

**Standard Specifications**

		Valve construction		
		Metal seal	Rubber seal	
Valve specifications	Fluid	Air		
	Maximum operating pressure	1.0 MPa		
	Min. operating pressure	Single	0.15 MPa	0.20 MPa
		Double	0.15 MPa	0.15 MPa
		3 position	0.15 MPa	0.20 MPa
	Ambient and fluid temperature	-10 to 60°C <sup>(1)</sup>	-5 to 60°C <sup>(1)</sup>	
	Lubrication	Not required		
	Manual override	Push type (Tool required)		
	Impact/Vibration resistance	150/30 m/s <sup>2</sup> (2)		
	Enclosure	IP65 (Dusttight, Low jetproof)		
	Coil rated voltage	12 VDC, 24 VDC, 100 VAC, 110 VAC, 200 VAC, 220 VAC, 240 VAC (50/60Hz)		
	Allowable voltage fluctuation	±10% of rated voltage		
	Coil insulation type	Class B or equivalent		
	Solenoid specifications	Power consumption (Current)	24 VDC	1W DC (42 mA)
12 VDC			1W DC (83 mA)	
100 VAC <sup>(3)</sup>			1.2 VA (12 mA)	
110 VAC <sup>(3)</sup>			1.3 VA (11.5 mA)	
120 VAC <sup>(3)</sup>			1.5 VA (12 mA)	
200 VAC <sup>(3)</sup>			2.5 VA (12.5 mA)	
220 VAC <sup>(3)</sup>			2.6 VA (13 mA)	
230 VAC <sup>(3)</sup>			2.8 VA (12.5 mA)	
240 VAC <sup>(3)</sup>	3 VA (13 mA)			

Note 1) Use dry air to prevent condensation when operating at low temperatures.

Note 2) Impact resistance: No malfunction occurred when it is tested with a drop tester in the axial direction and at the right angles to the main valve and armature in both energized and de-energized states every once for each condition. (Values at the initial period)

Vibration resistance: No malfunction occurred in a one-sweep test between 45 and 2000 Hz. Test was performed at both energized and de-energized states in the axial direction and at the right angles to the main valve and armature. (Values at the initial period)

Note 3) The valve with an AC coil comes with a rectifying device; therefore, there is no difference in the consumption current when it is in the inrush and holding states.

- SV
- SYJ
- SZ
- VF
- VP4
- VQ 1/2
- VQ 4/5
- VQC 1/2
- VQC 4/5
- VQZ
- SQ
- VFS
- VFR
- VQ7

# VQ7-6 Series

## DIN Terminal Type

2 position single : VQ7-6-FG-S  
single (Reverse pressure): VQ7-6-YZ-S

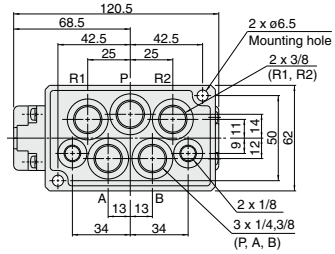
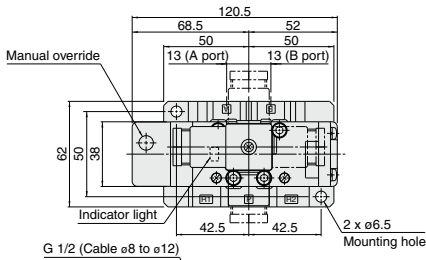

Bottom ported drawing

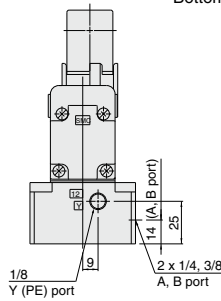
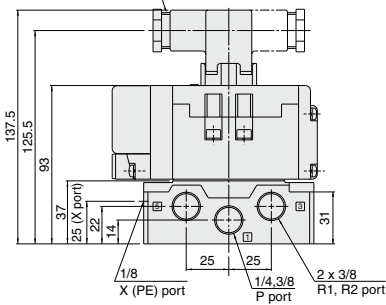

2 position double : VQ7-6-FG-D  
double (Reverse pressure): VQ7-6-YZ-D

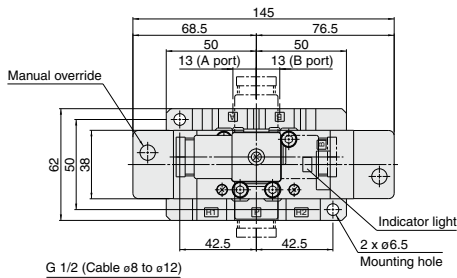

3 position closed center : VQ7-6-FHG-D  
exhaust center : VQ7-6-FJG-D  
pressure center: VQ7-6-FIG-D

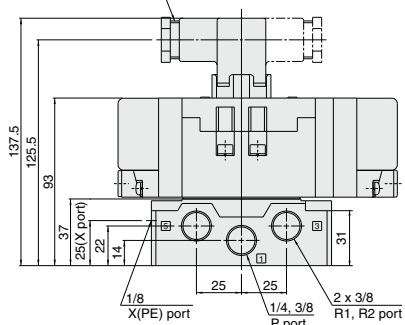
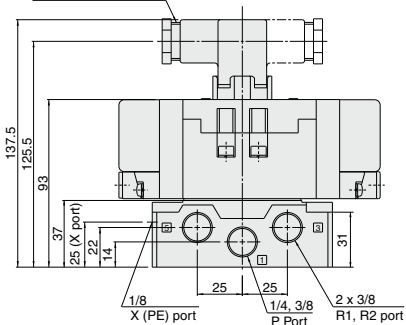
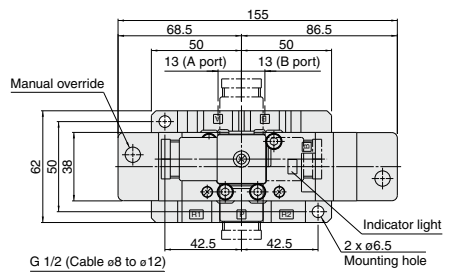

**Prewired Connector Type**

**2 position single** : VQ7-6-FG-S□□□□SC  
**single (Reverse pressure):** VQ7-6-YZ-S□□□□SC

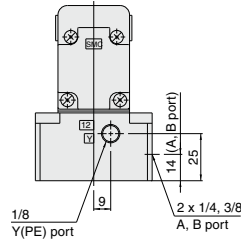
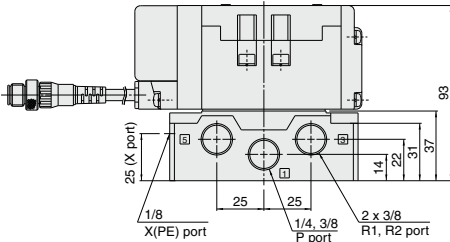
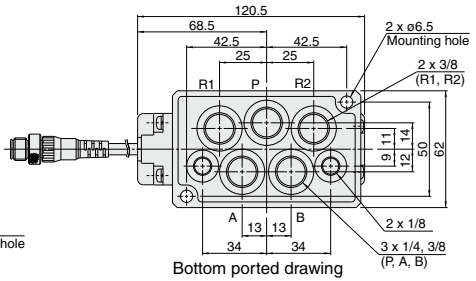
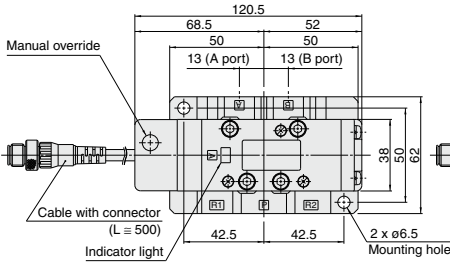

**2 position double** : VQ7-6-FG-D□□□□SC  
**double (Reverse pressure):** VQ7-6-YZ-D□□□□SC

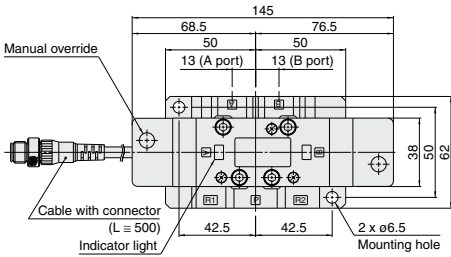

**3 position closed center** : VQ7-6-FHG-D□□□□SC  
**exhaust center** : VQ7-6-FJG-D□□□□SC  
**pressure center:** VQ7-6-FIG-D□□□□SC

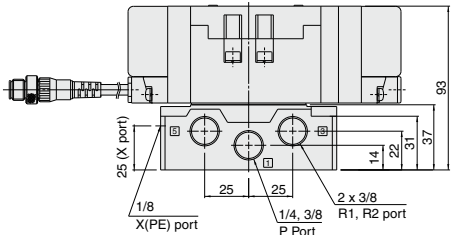
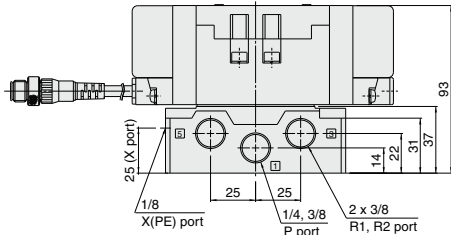
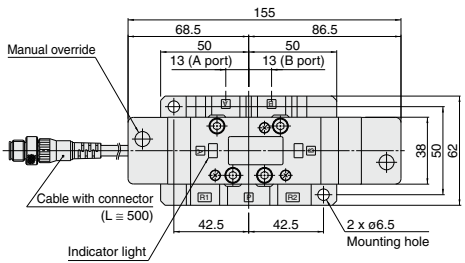

SV
SYJ
SZ
VF
VP4
VQ 1/2
VQ 4/5
VQC 1/2
VQC 4/5
VQZ
SQ
VFS
VFR
VQ7

# VQ7-6 Series Construction

## DIN Terminal Type

### Metal seal type

#### VQ7-6-FG-S-□

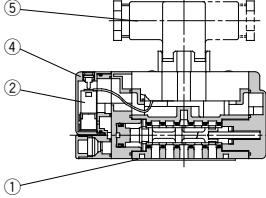

#### VQ7-6-FG-D-□

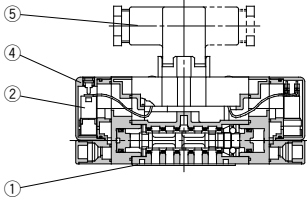

#### VQ7-6-<sup>FHG</sup><sub>FJG</sub>-D-□

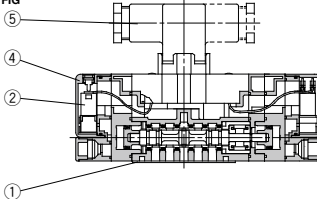

#### VQ7-6-FPG-D-□

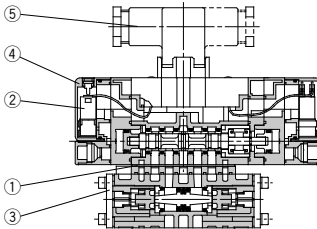

### Rubber seal type

#### VQ7-6-FG-S-□R□

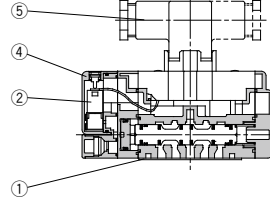

#### VQ7-6-FG-D-□R□

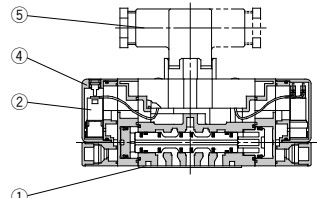

#### VQ7-6-<sup>FHG</sup><sub>FJG</sub>-D-□R□

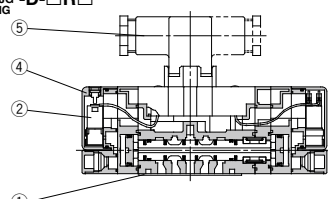

## Replacement Parts (For valve)

No.	Description	VQ7-6-FG-S-□	VQ7-6-FG-D-□	VQ7-6- <sup>FHG</sup> <sub>FJG</sub> -D-□	VQ7-6-FPG-D-□	VQ7-6-FG-S-□R□	VQ7-6-FG-D-□R□	VQ7-6- <sup>FHG</sup> <sub>FJG</sub> -D-□R□
1	Gasket					VQ7060-13-4-1		
2	Pilot valve assembly <sup>(1)</sup> <sup>(2)</sup>			VQZ110Q-□ (5: 24 VDC, 6: 12 VDC, 1: For AC <sup>(3)</sup> )				
3	Double check spacer		—		VV71-FPG		—	
4	Pilot valve cover				VQ7060-9A-1			
5	DIN terminal				UKL-S1			

Note 1) When the voltage is the same, the replacement of pilot valve assembly is possible.

Note 2) Since the substrate circuit in the valve is different, voltage cannot be changed with the pilot valve assembly.

Note 3) The pilot valve for 100 to 240 VAC is common.



# Manifold VV71 Series

# VQ7-6 Series



## How to Order Manifold

**VV71 6 - 02R - - - 02D - - -**

**Stations**

1	1 station
:	:
10	10 stations

Note) When equipped with control unit, 1 or 2 stations are used for mounting.

**2 (B), 4 (A) port connection**

02R	1/4 (R side)
03R	3/8 (R side)
02L	1/4 (L side)
03L	3/8 (L side)
02Y	1/4 (Bottom side)
03Y	3/8 (Bottom side)
C6R	One-touch fitting ø6 (R side)
C8R	One-touch fitting ø8 (R side)
C10R	One-touch fitting ø10 (R side)
C6L	One-touch fitting ø6 (L side)
C8L	One-touch fitting ø8 (L side)
C10L	One-touch fitting ø10 (L side)
*	Mixed

Note) When ports are mixed, indicate piping specifications by means of the manifold specification sheet.

**Thread type**

Nil	Rc
F	G
T	NPTF

Note) With One-touch fittings: Nil

**CE-compliant**

Nil	—
Q	CE-compliant

**Silencer box**

Nil	None
SB	With

Note) The silencer box is mounted on the end plate located on the side (D, U, B) that is selected in "1(P), 3(R2), 5(R1) port connection".

**Air release valve coil rating**

Nil	None
1	100 VAC, 50/60 Hz
2	200 VAC, 50/60 Hz
3	24 VDC
4	12 VDC
5	110 VAC, 50/60 Hz
6	220 VAC, 50/60 Hz

For other rated voltages, please consult with SMC.

**Thread type**

Nil	Rc
F	G
T	NPTF

Note) With One-touch fittings: Nil

**1(P), 3(R2), 5(R1) port connection**

02D	1/4 (D side)
02U	1/4 (U side)
02B	1/4 (Both sides)
03D	3/8 (D side)
03U	3/8 (U side)
03B	3/8 (Both sides)
C12D	One-touch fitting ø12 (D side)
C12U	One-touch fitting ø12 (U side)
C12B	One-touch fitting ø12 (Both sides)
*	Mixed

Note) When ports are mixed, indicate piping specifications by means of the manifold specification sheet.

**Control unit type (See pages 1130 and 1131 for details.)**

Control equipment	Symbol								
	Nil	A	AP	M	MP	F	G	C	E
Air filter with auto-drain	○	○				○			
Air filter with manual drain				○	○		○		
Regulator	○	○	○	○	○	○			
Air release valve	○	○	○	○				○	○
Pressure switch			○		○				
Blanking plate (Air release valve)						○	○		
Blanking plate (Filter, Regulator)								○	
Blanking plate (Pressure switch)	○			○		○	○	○	
Number of manifold blocks required for mounting (stations)	2	2	2	2	2	2	2	2	1

## Manifold Specifications

Manifold block size	Applicable solenoid valve	Porting specifications			Stations	Weight (kg)
		2(B), 4(A) port		1(P), 3(R2)		
		Port location	Port size	5(R1) port size		
ISO size 1	VQ7-6 Series ISO size 1	Right, Left	1/4 3/8 C6 (ø6) C8 (ø8) C10 (ø10)	1/4 3/8 C12 (ø12)	Note) Max. 10 stations	0.43n + 0.49 (n: Stations)
		Bottom	1/4 3/8			

Note) When equipped with control unit, 1 or 2 stations are used for mounting.



SV
SYJ
SZ
VF
VP4
VQ 1/2
VQ 4/5
VQC 1/2
VQC 4/5
VQZ
SQ
VFS
VFR
VQ7

# VQ7-6 Series

## DIN Terminal Type

VV71□-□-□□□

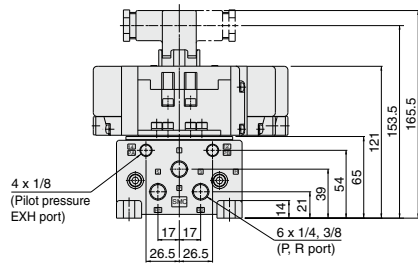
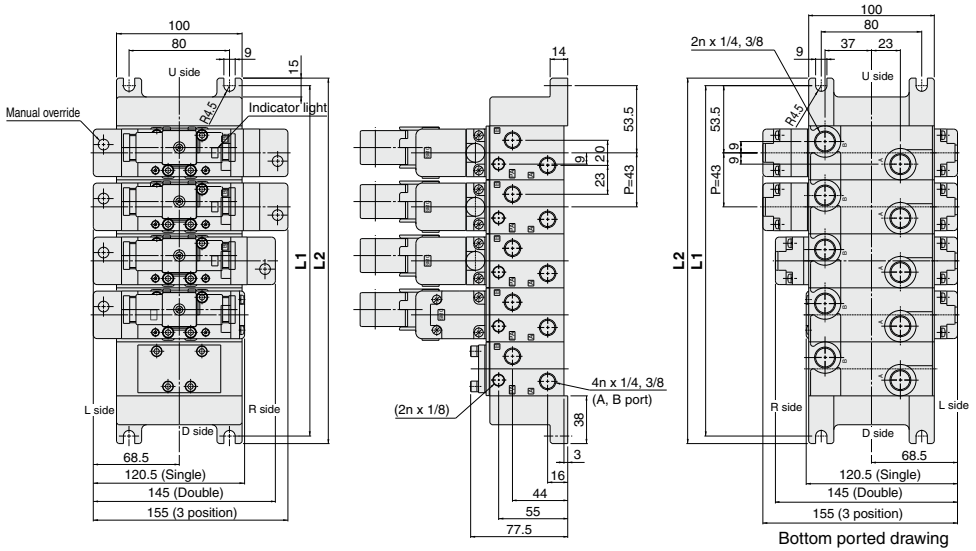

### L Dimension

n: Stations

	1	2	3	4	5	6	7	8	9	10	Formula
L1	107	150	193	236	279	322	365	408	451	494	$L1 = 43n + 64$
L2	119	162	205	248	291	334	377	420	463	506	$L2 = 43n + 76$

**Prewired Connector Type**

VV71□-□-□□□

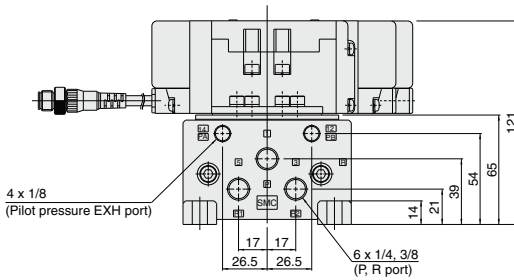
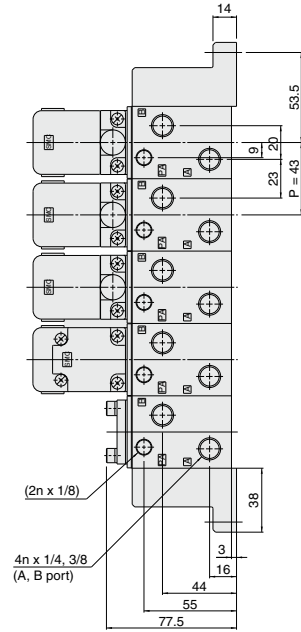
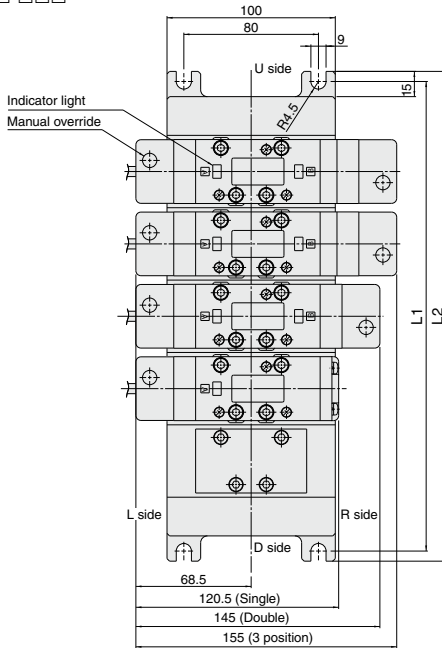

- SV
- SYJ
- SZ
- VF
- VP4
- VQ 1/2
- VQ 4/5
- VQC 1/2
- VQC 4/5
- VQZ
- SQ
- VFS
- VFR
- VQ7**

**L Dimension**

n: Stations

	1	2	3	4	5	6	7	8	9	10	Formula
<b>L1</b>	107	150	193	236	279	322	365	408	451	494	$L1 = 43n + 64$
<b>L2</b>	119	162	205	248	291	334	377	420	463	506	$L2 = 43n + 76$

# VQ7-6 Series

## Manifold Option Parts

### Blanking plate assembly AXT502-9A

It is used by attaching on the manifold block for being prepared for removing a valve for maintenance reasons or planning to mount a spare valve, etc.

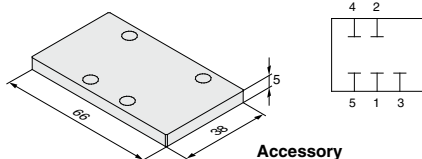

#### Accessory

Description	Part no.	Qty.
Gasket	AXT500-13	1
Bolt	AXT632-45-2	4

### Block plate (For SUP/EXH passages) AXT502-14

When two or more different high pressures are supplied to one manifold, block plates are installed between stations having different pressures.

Also, in cases such as when valve exhaust effects other stations in a circuit, block plates are used for exhaust at stations where the exhaust is to be separated.

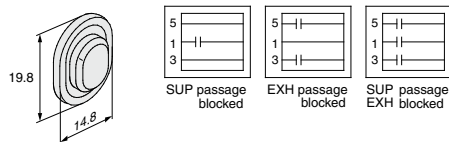

### Individual SUP spacer VV71-P-02

03  
C10

#### Thread type

Nil	Rc
F	G
T	NPTF

Note) It is not applicable to One-touch fittings.

By mounting individual SUP spacers on a manifold block, it is possible to provide individual supply ports for each valve.

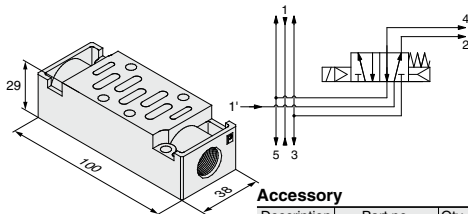

#### Accessory

Description	Part no.	Qty.
Gasket	AXT500-13	1
Bolt	AXT632-45-6	4

### Block plate (For pilot EXH passage) AZ503-53A

When a valve's pilot valve exhaust effects other valves in a circuit, block plates are used between stations where the pilot exhaust passages are to be separated.

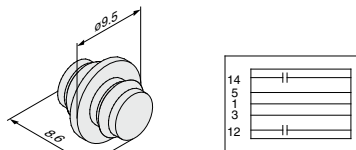

### Individual EXH spacer VV71-R-02

03  
C12

#### Thread type

Nil	Rc
F	G
T	NPTF

Note) It is not applicable to One-touch fittings.

By mounting individual EXH spacers on a manifold block, exhaust ports can be provided individually for each valve. (3, 5 common EXH type)

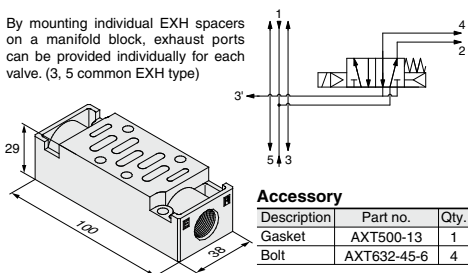

#### Accessory

Description	Part no.	Qty.
Gasket	AXT500-13	1
Bolt	AXT632-45-6	4

### Throttle valve spacer AXT503-23A

A throttle valve spacer is mounted on a manifold block to control cylinder speed by throttling exhaust air flow.

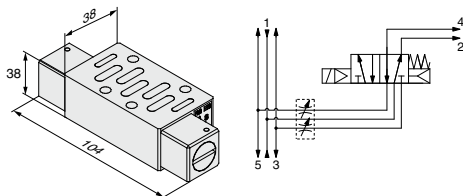

#### Accessory

Description	Part no.	Qty.
Gasket	AXT500-13	1
Bolt	AXT632-45-5	4

**Reverse pressure spacer**

**AXT502-21A-1** □

**Thread type**

Nil	Rc
F	G
T	NPTF

With reverse pressure control manifold specifications, when pressure is changed individually on one side (ex. high speed cylinder return), pressure can be supplied individually to the R2 side by mounting a reverse pressure spacer. {Port 3 (R2) is individual and 5 (R1) is common.}

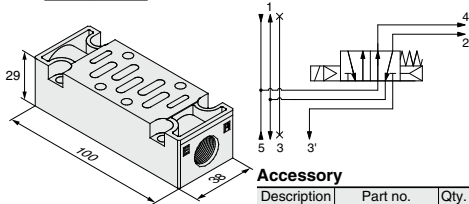

**Accessory**

Description	Part no.	Qty.
Gasket	AXT500-13	1
Bolt	AXT632-45-6	4

**Residual pressure release valve spacer**  
**VV71-R-AB**

This is used by mounting on a manifold block in order to exhaust the residual pressure trapped inside of a cylinder, etc., during an intermediate stop with a 3 position closed center or perfect type valve.

Residual pressure at ports A and B is exhausted individually to the outside by manual operation.

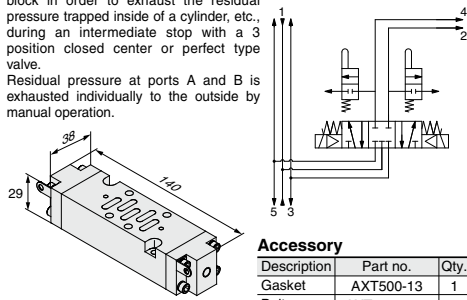

**Accessory**

Description	Part no.	Qty.
Gasket	AXT500-13	1
Bolt	AXT632-45-6	4

**R1, R2 individual EXH spacer**

**VV71-R2-03** □

**Thread type**

Nil	Rc
F	G
T	NPTF

By mounting an individual EXH spacer on a manifold block, individual exhaust is possible from both R1 and R2. (3 (R2) and 5 (R1) are individual ports.)

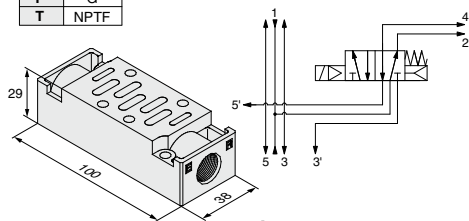

**Accessory**

Description	Part no.	Qty.
Gasket	AXT500-13	1
Bolt	AXT632-45-6	4

**Individual SUP spacer with residual pressure release valve**  
**VV71-PR-02/03** □

**Thread type**

Nil	Rc
F	G
T	NPTF

This is used by mounting on a manifold block in order to stop the inlet side supply pressure in an individual supply spacer, while at the same time exhausting the residual pressure are performed by pressing the manual override, which can be locked by turning it.

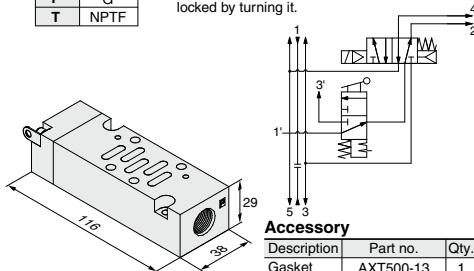

**Accessory**

Description	Part no.	Qty.
Gasket	AXT500-13	1
Bolt	AXT632-45-6	4

**Main EXH back pressure check plate**

**AXT503-37A**

In cases where back pressure effects actuator operation due to simultaneous operation of manifold valves, etc., this effect can be eliminated by installing a plate between the manifold block and the valve from which back pressure is to be prevented.

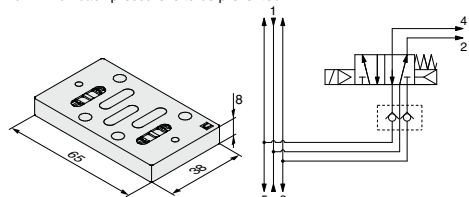

**Accessory**

Description	Part no.	Qty.
Gasket	AXT500-13	1
Bolt	AXT632-45-4	4

**Adapter plate for locked-up cylinder**

**AXT502-26A** □

**Thread type**

Nil	Rc 1/4
F	G 1/4
T	NPTF 1/4

When using a locked-up cylinder with 2 valves for control, this spacer can be used by mounting on a manifold block. It consists of a circuit equipped with a function to prevent lurching during release.

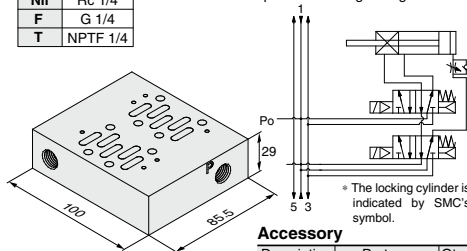

\* The locking cylinder is indicated by SMC's symbol.

**Accessory**

Description	Part no.	Qty.
Gasket	AXT500-13	2
Bolt	AXT632-45-6	8

SV
SYJ
SZ
VF
VP4
VQ 1/2
VQ 4/5
VQC 1/2
VQC 4/5
VQZ
SQ
VFS
VFR
VQ7

# VQ7-6 Series

## Manifold Option Parts

### Silencer box

VV71-□□□-□□-SB

This can be provided as a unit on the end plate to reduce manifold exhaust noise and piping labor.

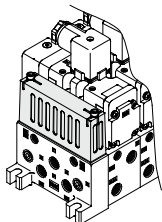

### Pilot EXH silencer

AN110-01

This is used by mounting on the pilot exhaust port in order to reduce manifold and single type pilot exhaust noise, and to prevent the entry of dust.

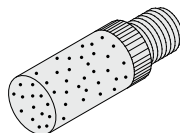

### Release valve spacer

AXT502-17A □

#### Thread type

Nil	Rc 3/8
F	G 3/8
T	NPTF 3/8

Combination of VQ7-6-FG-S (Single) and release valve spacer can be used as air release valve.  
 (Note) Mounting on 2 position double and 3 position valves is not possible.

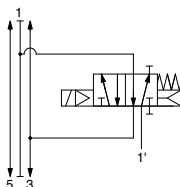
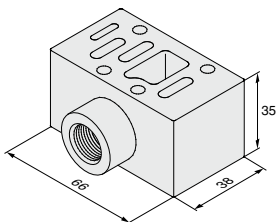

#### Accessory

Description	Part no.	Qty.
Gasket	AXT500-13	1
Bolt	AXT643-45-7	4

### Residual pressure release valve spacer

AZ503-82 □

#### Pilot type

A	Internal pilot
B	External pilot

At the same time as pilot pressure is released, residual pressure between the cylinder and valve is released.  
 There are two pilot types: internal pilot and external pilot types.

AZ503-82A

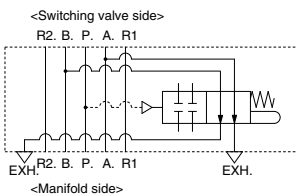
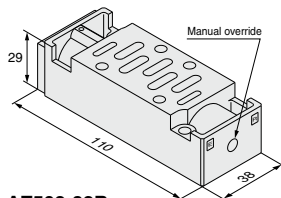

#### Accessory

Description	Part no.	Qty.
Gasket	AXT500-13	1
Bolt	AXT632-45-6	4

AZ503-82B

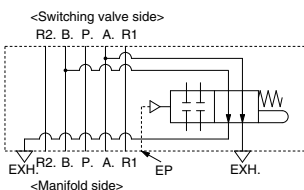
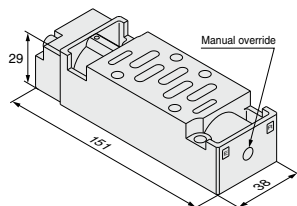

#### Specifications

Model	AZ503-82A	AZ503-82B
Switching signal type (Pilot type)	Internal pilot	External pilot
Applicable solenoid valve	VQ7-6	
Applicable sub-plate	ISO standard size 1	
Max. operating pressure	1.0 MPa	
Min. operating pressure	0.15 MPa (Pressure generated when the valve element is switched to the stopping side.)	
Ambient and fluid temperature	5 to 60°C	
Lubrication	Non-lube (Use turbine oil Class 1 (ISO VG32), if lubricated.)	

**Double check spacer**  
**VV71-FPG**

By combining a 3 position exhaust center valve with a double check spacer, an intermediate stopping position of a cylinder can be held for an extended period. It can also be used for drop prevention at the cylinder stroke end when releasing residual supply pressure, by combining it with a 2 position single or double valve.

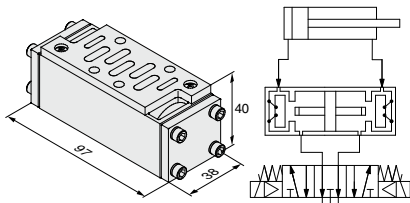

**Accessory**

Description	Part no.	Qty.
Gasket	AXT500-13	1
Bolt	AXT632-45-8	4

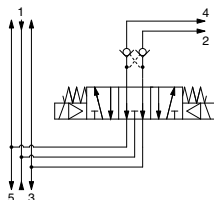

**Double check spacer with residual pressure release valve**  
**VV71-FPGR**

This is a double check spacer equipped with a residual pressure release function, to release residual pressure inside a cylinder during maintenance or adjustment, etc.

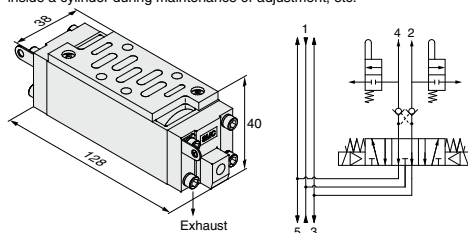

**Accessory**

Description	Part no.	Qty.
Gasket	AXT500-13	1
Bolt	AXT632-45-8	4

**⚠ Caution**

- Since extended cylinder stops are not possible if there are leaks from piping between the valve and cylinder or from fittings, etc., check for leakage using a neutral liquid detergent.
- Since One-touch fittings allow slight air leakage, screw piping is recommended when stopping the cylinder in the middle for a long time.
- Combination of 3 position, closed center and pressure center valves is not possible.
- Set the load weight so that the cylinder side pressure is less than two times the supply side pressure.
- When using the residual pressure release function, confirm the action of actuators, etc., and operate after providing for safety measures.
- Be aware that if the exhaust side of perfect spacer is restricted excessively, the intermediate stopping accuracy will decrease and will lead to improper intermediate stops.
- To combat the effects of back pressure, when required, we recommend installing an individual EXH spacer between the double check spacer and the manifold.

**Interface regulator**  
**ARB250-00-<sup>P</sup>/<sub>A</sub>/<sub>B</sub>**

Spacer interface regulators can be placed on top of the manifold block to reduce the pressure of each of the valves.

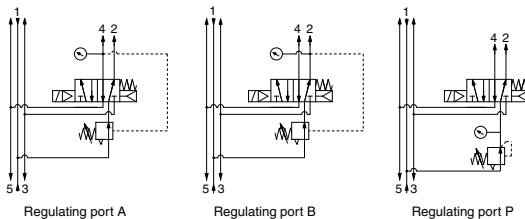
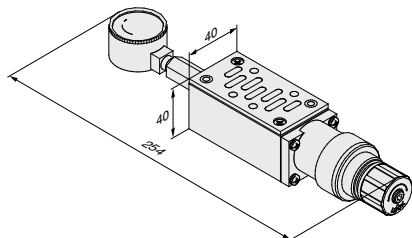

**Accessory**

Description	Part no.	Qty.
Gasket	AXT500-13	1
Bolt	AXT632-45-8	4

**Part No.**

P reduced pressure	ARB250-00-P
A reduced pressure	ARB250-00-A
B reduced pressure	ARB250-00-B

**⚠ Caution**

- When combining a pressure center valve and interface regulator with reduced pressure at ports A and B, use model ARB210-<sup>A</sup>/<sub>B</sub>.
- When combining a reverse pressure valve and interface regulator, use model ARB210-<sup>A</sup>/<sub>B</sub>. Further, it cannot be used with reduced pressure at port P.
- When combining a double check valve and an interface regulator, use a manifold or sub-plate as a basis, and stack them in the following order; the perfect spacer → the interface regulator → the valve.
- When a closed center valve is combined with the interface regulator's A, B port regulation, note that it cannot be used for intermediate stops of a cylinder because there is leakage from relief port on the regulator.

SV  
SYJ  
SZ  
VF  
VP4  
VQ 1/2  
VQ 4/5  
VQC 1/2  
VQC 4/5  
VQZ  
SQ  
VFS  
VFR  
VQ7

# VQ7-6 Series

## Control Unit

Control equipment (filters, regulators, pressure switches, air release valves) has been made into standardized units which can be mounted on manifolds without any modifications.

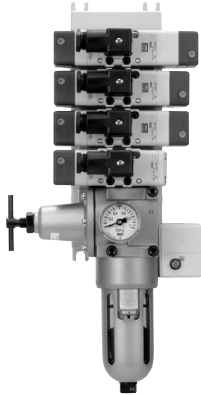

### Control Unit Specifications

Air filter (With auto-drain/With manual drain)	
Filtration degree	5 μm
Regulator	
Set pressure (Outlet pressure)	0.05 to 0.85 MPa
Pressure switch	
Pressure adjustment range	0.1 to 0.7 MPa
Contact	1 ab
Rated current	(Induction load) 125 VAC 15 A, 250 VAC 15 A
Air release valve (Single only)	
Operating pressure range	0.15 to 1.0 MPa

### Options

Blanking plate	AXT502-9A (For manifold)
	AXT502-18A (For release valve adapter plate)
	MP2 (For control equipment/filter regulator)
	MP3-1 (For pressure switch)
Release valve adapter plate	AXT502-17A
Pressure switch	IS3100-X230

### Manifold specifications example

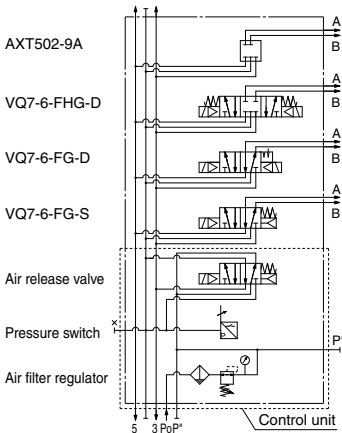

### Control Unit Type

Control equipment	Ordering symbol								
	NII	A	AP	M	MP	F	G	C	E
Air filter with auto-drain		○	○			○			
Air filter with manual drain				○	○		○		
Regulator		○	○	○	○	○	○		
Air release valve		○	○	○	○			○	○
Pressure switch			○		○				
Blanking plate (Air release valve)						○	○		
Blanking plate (Filter, Regulator)								○	
Blanking plate (Pressure switch)		○		○	○	○	○	○	
Number of manifold blocks required for mounting (stations)	2	2	2	2	2	2	2	2	1
	stations	stations	stations	stations	stations	stations	stations	stations	station

### Use of Control Unit

#### <Construction and piping >

- The supply pressure (Po) passes through the regulator with filter ① and is adjusted to the prescribed pressure. Next, it goes through the release valve ② (downstream residual pressure switching function used as normally ON) and is supplied to the manifold base side (P).
- When the release valve ② is OFF, the supply pressure from port Po is blocked, and the air which was being supplied to the manifold side port P passes through the release valve ② and is discharged from port R1.
- The pressure switch is piped into the outlet side of the release valve ②. (It operates when the release valve ② is energized.) Also, since there is an internal voltage drop of 4V, it may not be possible to confirm the OFF and ON states with a tester, etc.

#### ⚠ Caution

- In the case of air filters with auto-drain or manual drain, mount so that the air filter is at the bottom.



**Manifold with control unit**

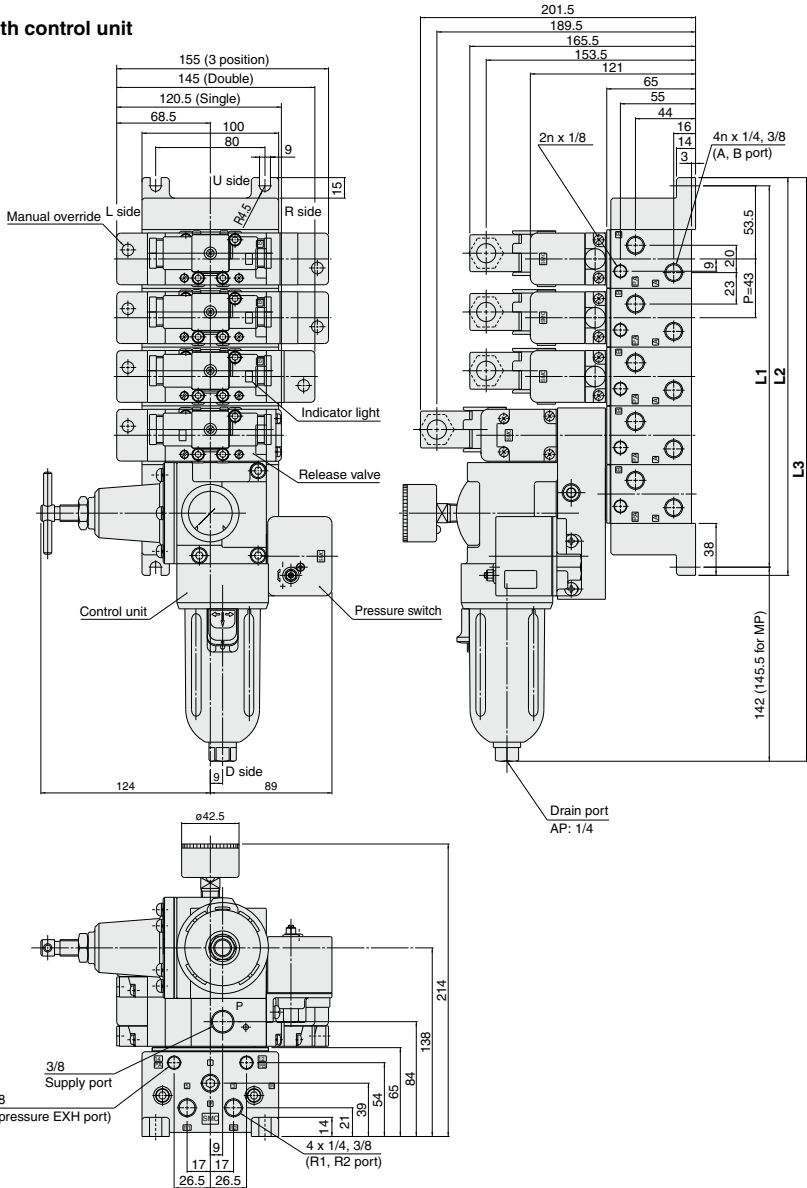

- SV
- SYJ
- SZ
- VF
- VP4
- VQ 1/2
- VQ 4/5
- VQC 1/2
- VQC 4/5
- VQZ
- SQ
- VFS
- VFR
- VQ7**

**L Dimension**

	1	2	3	4	5	6	7	8	9	10	Formula
<b>L1</b>	107	150	193	236	279	322	365	408	451	494	$L1 = 43n + 64$
<b>L2</b>	119	162	205	248	291	334	377	420	463	506	$L2 = 43n + 76$
<b>L3</b>	255	298	341	384	427	470	513	556	599	642	$L3 = 43n + 212 (215.5)$
	(258.5)	(301.5)	(344.5)	(387.5)	(430.5)	(473.5)	(516.5)	(559.5)	(602.5)	(645.5)	

L3 dimensions inside ( ) are for MP.

# VQ7-6 Series

## Manifold Option Parts

### Interface regulator

ARB250-00-<sup>P</sup><sub>A</sub><sup>B</sup>

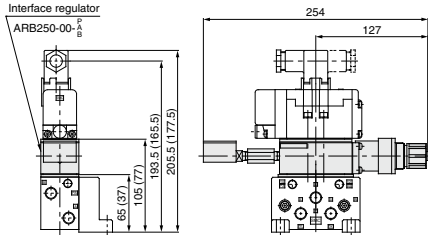

\* Dimensions inside ( ) are for sub-plate.

### Residual pressure release valve spacer

AZ503-82<sup>A</sup><sub>B</sub>

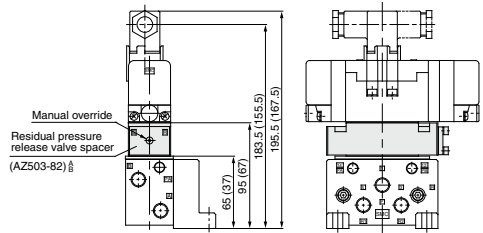

\* Dimensions inside ( ) are for sub-plate.

### Throttle valve spacer

AXT503-23A

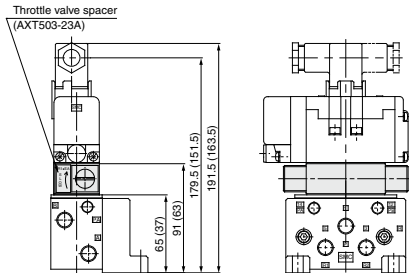

\* Dimensions inside ( ) are for sub-plate.

### Silencer box

AXT503-60A

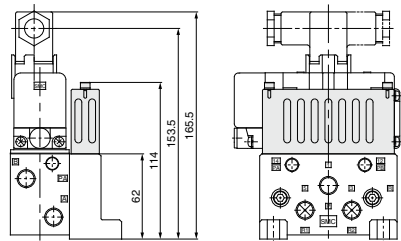

### Spare parts

Description	Part no.
Element	AXT503-60-2-4

**Individual SUP spacer**  
**Individual EXH spacer**  
**R1, R2 individual EXH spacer**  
**Reverse pressure spacer**

**VV71-P-□**  
**VV71-R-□**  
**VV71-R2-03**  
**AXT502-21A-1**

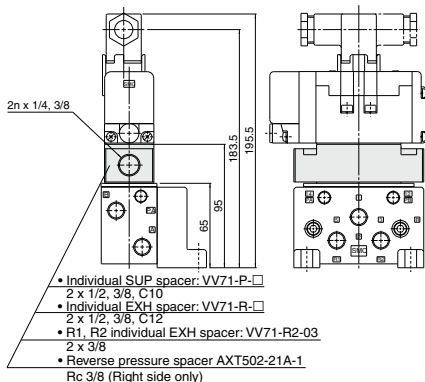

**Double check spacer**  
**Double check spacer with residual pressure release valve**

**VV71-FPG**  
**VV71-FPGR**

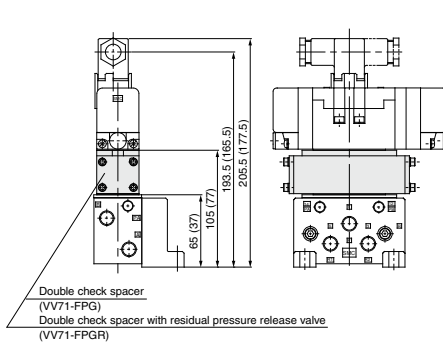

\* Dimensions inside ( ) are for sub-plate.

**Main EXH back pressure check plate**  
**AXT503-37A**

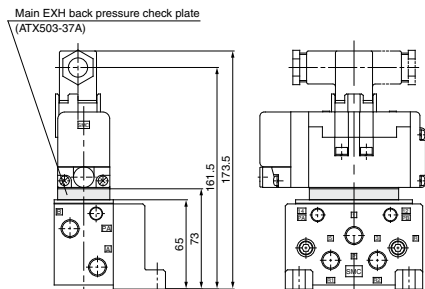

**Residual pressure release valve spacer**  
**Individual SUP spacer with residual pressure release valve**

**VV71-R-AB**  
**VV71-PR-□**

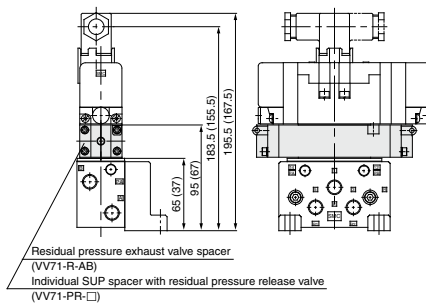

\* Dimensions inside ( ) are for sub-plate.

SV
SYJ
SZ
VF
VP4
VQ 1/2
VQ 4/5
VQC 1/2
VQC 4/5
VQZ
SQ
VFS
VFR
VQ7

# ISO Standard Solenoid Valve

# VQ7-8 Series

## Size 2/Single Unit



### How to Order Valves

**VQ7-8 - FG - S - 3** [ ] [ ] [ ] [ ] [ ] [ ] [ ] [ ] [ ]

**Passage symbol**

<b>FG</b>	
<b>YZ*</b>	
<b>FHG</b>	
<b>FJG</b>	
<b>FPG</b>	
<b>FIG</b>	

\* Semi-standard

**Number of solenoids**

<b>S</b>	Single
<b>D</b>	Double

**CE-compliant**

<b>Nil</b>	—
<b>Q</b>	CE-compliant

**Connector**

<b>Nil</b>	DIN terminal block (With connector)
<b>O</b>	DIN terminal block (Without connector)
<b>SC</b>	Pre-wired connector

**Sub-plate port size**

<b>Nil</b>	Without sub-plate
<b>A03</b>	Side ported 3/8
<b>A04</b>	Side ported 1/2
<b>A06D</b>	Side ported 3/4
<b>B03</b>	Bottom ported 3/8
<b>B04</b>	Bottom ported 1/2
<b>B06</b>	Bottom ported 3/4

**Thread type**

<b>Nil</b>	Rc
<b>F</b>	G
<b>T</b>	NPTF

**Seal**

<b>Nil</b>	Metal seal
<b>R</b>	Rubber seal

**Pilot exhaust**

<b>Nil</b>	Common exhaust
<b>V</b>	Individual exhaust

**Option**

<b>Nil</b>	None
<b>Z</b>	Light/Surge voltage suppressor
<b>N</b>	With indicator light

**Coil rated**

<b>1</b>	100 VAC, 50/60Hz
<b>2</b>	200 VAC, 50/60Hz
<b>3</b>	24 VDC
<b>4</b>	12 VDC
<b>5</b>	110 VAC, 50/60Hz
<b>6</b>	220 VAC, 50/60Hz

For other rated voltages, please consult with SMC.

### How to Order Sub-plate

**VS7-2 - A03** [ ] [ ]

**Port size**

<b>A03</b>	Side ported 3/8
<b>A04</b>	Side ported 1/2
<b>A06D</b>	Side ported 3/4
<b>B03</b>	Bottom ported 3/8
<b>B04</b>	Bottom ported 1/2
<b>B06</b>	Bottom ported 3/4

**Thread type**

<b>Nil</b>	Rc
<b>F</b>	G
<b>T</b>	NPTF

### Specifications

Model	Porting specifications		Weight (kg)
	Piping location	Port size	
<b>VS7-2-A03</b> □	Side	3/8	0.68
<b>VS7-2-A04</b> □		1/2	
<b>VS7-2-A06</b> □		3/4	
<b>VS7-2-B03</b> □	Bottom	3/8	0.68
<b>VS7-2-B04</b> □		1/2	
<b>VS7-2-B06</b> □		3/4	

**Model**

Series	Number of positions	Model	Port size	Flow rate characteristics						(1) Response time (ms)	(2) Weight (kg)				
				1 → 4/2 (P → A/B)			4/2 → 5/3 (A/B → EA/EB)								
				C [dm <sup>3</sup> /(s·bar)]	b	Cv	C [dm <sup>3</sup> /(s·bar)]	b	Cv						
VQ7-8	2 position	Single	Metal seal	VQ7-8-FG-S-□	3/8	10	0.18	2.4	12	0.24	3.0	40 or less	0.64		
			Rubber seal	VQ7-8-FG-S-□R		12	0.24	3.0	13	0.27	3.3	45 or less			
		Double	Metal seal	VQ7-8-FG-D-□	10	0.18	2.4	12	0.24	3.0	15 or less	0.70			
			Rubber seal	VQ7-8-FG-D-□R	12	0.24	3.0	13	0.27	3.3	20 or less				
	3 position	Closed center	Metal seal	VQ7-8-FHG-D-□	3/8	10	0.28	2.4	10	0.24	2.4	45 or less	0.75		
			Rubber seal	VQ7-8-FHG-D-□R		11	0.25	2.8	11	0.27	2.8	50 or less			
		Exhaust center	Metal seal	VQ7-8-FJG-D-□		10	0.16	2.4	10	0.20	2.4	45 or less	0.75		
			Rubber seal	VQ7-8-FJG-D-□R		11	0.26	2.8	13	0.27	3.3	50 or less			
		Double check	Metal seal	VQ7-8-FPG-D-□		7.2	–	–	7.0	–	–	60 or less	1.98		
				Rubber seal		VQ7-8-FPG-D-□R	7.2	–	–	7.0	–	–		60 or less	
			Pressure center	Metal seal		VQ7-8-FIG-D-□	10	0.26	2.4	11	0.25	2.8		45 or less	0.75
				Rubber seal		VQ7-8-FIG-D-□R	13	0.27	3.3	12	0.29	3.0		50 or less	

Note 1) Based on JIS B 8419: 2010 (Value for supply pressure of 0.5 MPa, with light/surge voltage suppressor, when using clean air.) Response time values will change depending on pressure and air quality. Value when ON for double type.

Note 2) Weight without sub-plate. (Sub-plate: 3/8, 1/2: 0.68 kg, 3/4: 1.29 kg)



**Standard Specifications**

		Metal seal	Rubber seal	
Valve specifications	Valve construction	Metal seal	Rubber seal	
	Fluid	Air		
	Maximum operating pressure	1.0 MPa		
	Min. operating pressure	Single	0.15 MPa	0.20 MPa
		Double	0.15 MPa	0.15 MPa
		3 position	0.15 MPa	0.20 MPa
	Ambient and fluid temperature	-10 to 60°C <sup>(1)</sup>	-5 to 60°C <sup>(1)</sup>	
	Lubrication	Not required		
	Manual override	Push type (Tool required)		
	Impact/Vibration resistance	150/30 m/s <sup>2</sup> <sup>(2)</sup>		
Enclosure	IP65 (Dusttight, Low J waterproof)			
Solenoid specifications	Coil rated voltage	12 VDC, 24 VDC, 100 VAC, 110 VAC, 200 VAC, 220 VAC, 240 VAC (50/60Hz)		
	Allowable voltage fluctuation	±10% of rated voltage		
	Coil insulation type	Class B or equivalent		
	Power consumption (Current)	24 VDC	1 WDC (42 mA)	
		12 VDC	1 WDC (83 mA)	
		100 VAC <sup>(3)</sup>	1.2 VA (12 mA)	
		110 VAC <sup>(3)</sup>	1.3 VA (11.5 mA)	
		120 VAC <sup>(3)</sup>	1.5 VA (12 mA)	
		200 VAC <sup>(3)</sup>	2.5 VA (12.5 mA)	
		220 VAC <sup>(3)</sup>	2.6 VA (13 mA)	
230 VAC <sup>(3)</sup>	2.8 VA (12.5 mA)			
240 VAC <sup>(3)</sup>	3 VA (13 mA)			

Note 1) Use dry air to prevent condensation when operating at low temperatures.

Note 2) Impact resistance: No malfunction occurred when it is tested with a drop tester in the axial direction and at the right angles to the main valve and armature in both energized and de-energized states every once for each condition. (Values at the initial period)

Vibration resistance: No malfunction occurred in a one-sweep test between 45 and 2000 Hz. Test was performed at both energized and de-energized states in the axial direction and at the right angles to the main valve and armature. (Values at the initial period)

Note 3) Since AC coil specifications include a rectifying device, there is no difference in power consumption between inrush and holding.

**Symbol**

2 position single

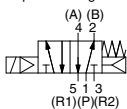

2 position double (Metal)

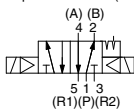

2 position double (Rubber)

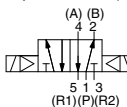

3 position closed center

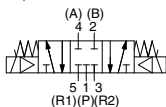

3 position exhaust center

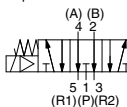

3 position double check

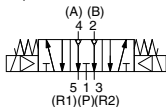

3 position pressure center

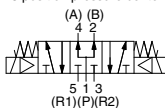

SV

SYJ

SZ

VF

VP4

VQ 1/2

VQ 4/5

VQC 1/2

VQC 4/5

VQZ

SQ

VFS

VFR

VQ7

# VQ7-8 Series

## DIN Terminal Type

**2 position single** : VQ7-8-FG-S  
**single (Reverse pressure):** VQ7-8-YZ-S

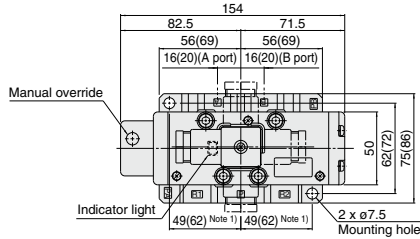

Bottom ported drawing

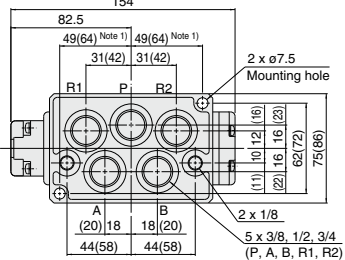

G 1/2 (Cable ø8 to ø12)

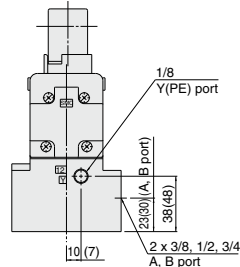
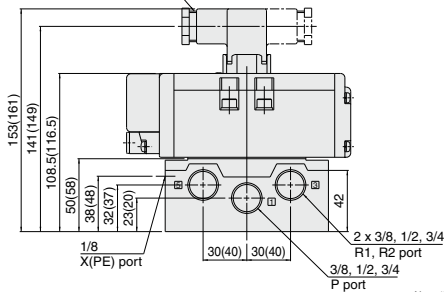

\* ( ) : 3/4

Note 1) For 3/4, the mounting hole pitch differs between the side ported type and the bottom ported type.

**2 position double** : VQ7-8-FG-D  
**double (Reverse pressure):** VQ7-8-YZ-D

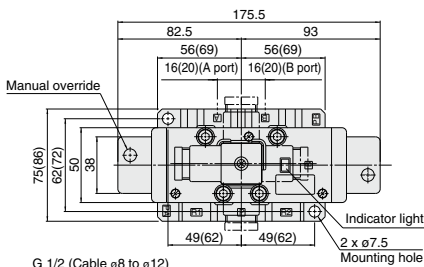

**3 position closed center** : VQ7-8-FHG-D  
**exhaust center** : VQ7-8-FJG-D  
**pressure center:** VQ7-8-FIG-D

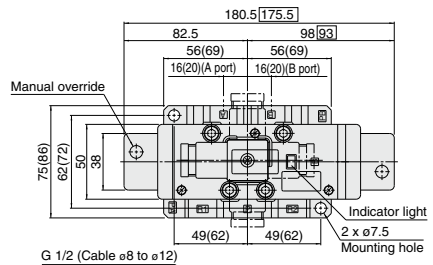

G 1/2 (Cable ø8 to ø12)

G 1/2 (Cable ø8 to ø12)

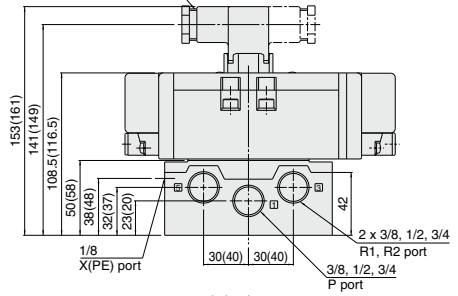
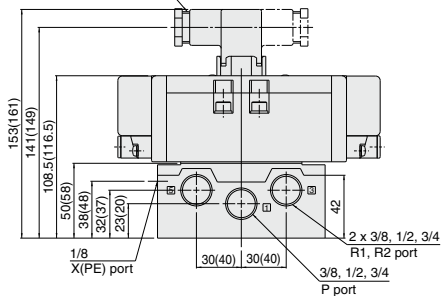

\* ( ) : 3/4

\* ( ) : 3/4

Dimensions inside □ are for rubber seals.

**Prewired Connector Type**

**2 position single** : VQ7-8-FG-S-□□□□SC  
**single (Reverse pressure):** VQ7-8-YZ-S-□□□□SC

Bottom ported drawing

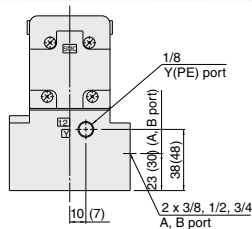
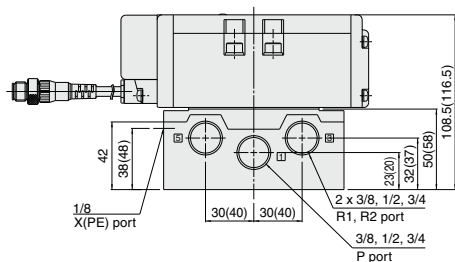
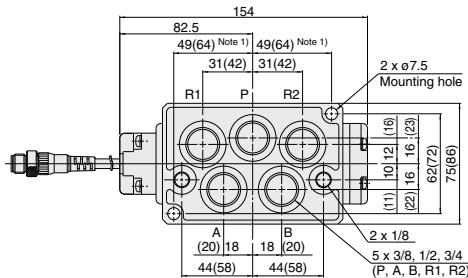
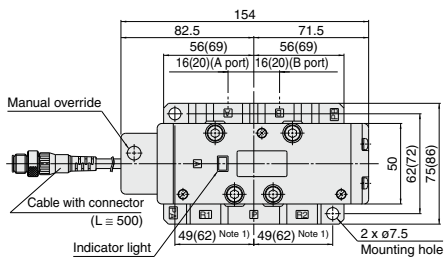

\* ( ) : 3/4

Note 1) For 3/4, the mounting hole pitch differs between the side ported type and the bottom ported type.

**2 position double** : VQ7-8-FG-D-□□□□SC  
**double (Reverse pressure):** VQ7-8-YZ-D-□□□□SC

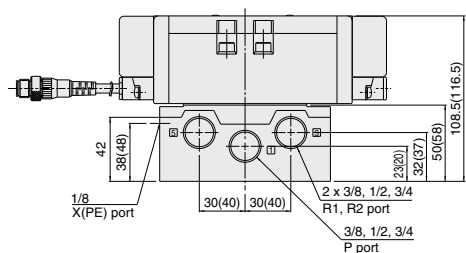
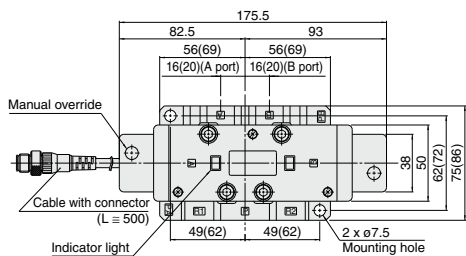

\* ( ) : 3/4

**3 position closed center** : VQ7-8-FHG-D-□□□□SC  
**exhaust center** : VQ7-8-FJG-D-□□□□SC  
**pressure center:** VQ7-8-FIG-D-□□□□SC

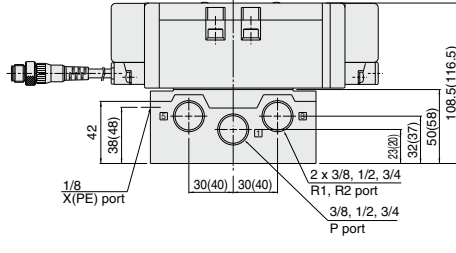
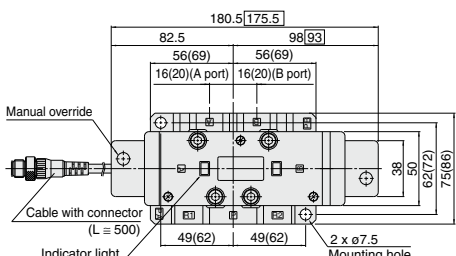

\* ( ) : 3/4

Dimensions inside □ are for rubber seals.

SV
SYJ
SZ
VF
VP4
VQ 1/2
VQ 4/5
VQC 1/2
VQC 4/5
VQZ
SQ
VFS
VFR
VQ7

# VQ7-8 Series Construction

## DIN Terminal Type

### Metal seal

#### VQ7-8-FG-S-□

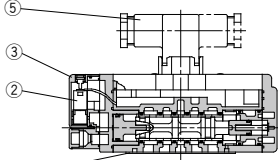

#### VQ7-8-FG-D-□

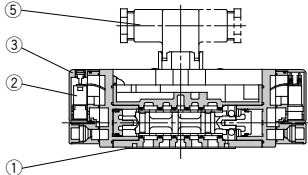

#### VQ7-8-<sup>FHG</sup><sub>FJG</sub>-D-□ FIG

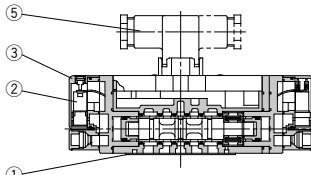

#### VQ7-8-FPG-D-□

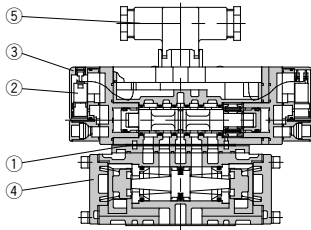

### Rubber seal type

#### VQ7-8-FG-S-□R□

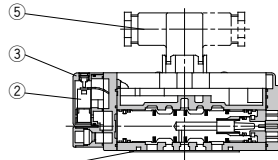

#### VQ7-8-FG-D-□R□

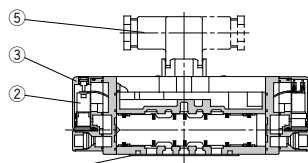

#### VQ7-8-<sup>FHG</sup><sub>FJG</sub>-D-□R□ FIG

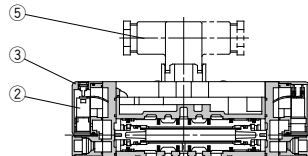

## Replacement Parts (For valve)

Number	Description	VQ7-8-FG-S-□	VQ7-8-FG-D-□	VQ7-8- <sup>FHG</sup> <sub>FJG</sub> -D-□	VQ7-8-FPG-D-□	VQ7-8-FG-S-□R□	VQ7-8-FG-D-□R□	VQ7-8- <sup>FHG</sup> <sub>FJG</sub> -D-□R□
1	Gasket				VQ7080-13-4-1			
2	Pilot valve assembly <sup>(1)</sup> <sup>(2)</sup>				VQZ110Q-□ (5: 24 VDC, 6: 12 VDC, 1: For AC <sup>(3)</sup> )			
3	Pilot valve cover				VQ7060-9A-1			
4	Double check spacer			—	VV72-FPG		—	
5	DIN terminal				UKL-S1			

Note 1) When the voltage is the same, the replacement of pilot valve assembly is possible.

Note 2) Since the substrate circuit in the valve is different, voltage cannot be changed with the pilot valve assembly.

Note 3) The pilot valve for 100 to 240 VAC is common.



# Manifold VV72 Series

# VQ7-8 Series



## How to Order Manifold

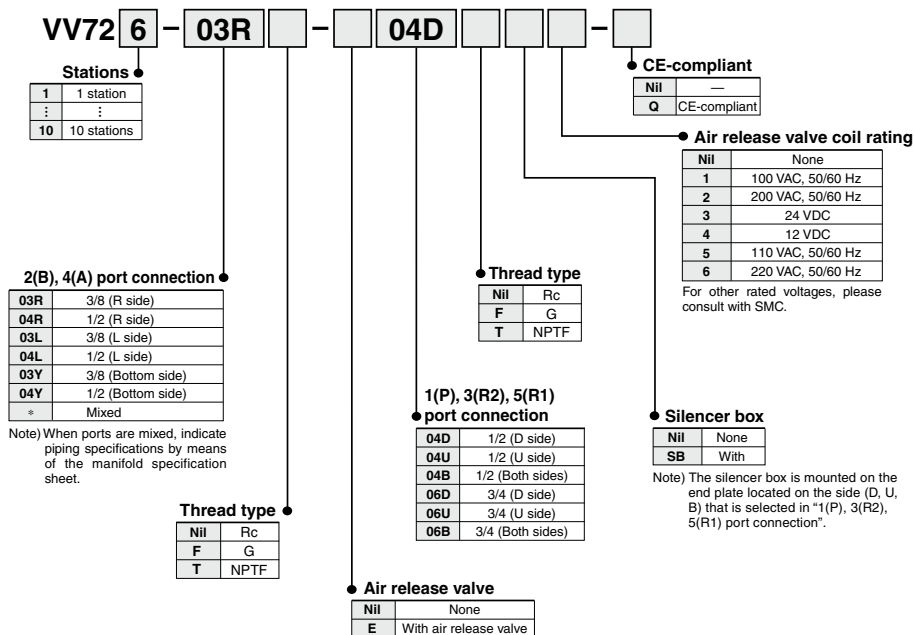

SV
SYJ
SZ
VF
VP4
VQ 1/2
VQ 4/5
VQC 1/2
VQC 4/5
VQZ
SQ
VFS
VFR
VQ7

## Manifold Specifications

Manifold block size	Applicable solenoid valve	Porting specifications		Stations	Weight (kg)
		2(B), 4(A) port size	1(P), 3(R2) 5(R1) port size		
ISO size 2	VQ7-8 Series ISO size 2	3/8 1/2	1/2 3/4	Max. 10 stations	0.96n + 0.77 (n: Stations)

# VQ7-8 Series

## DIN Terminal Type

VV72□-□-□□□

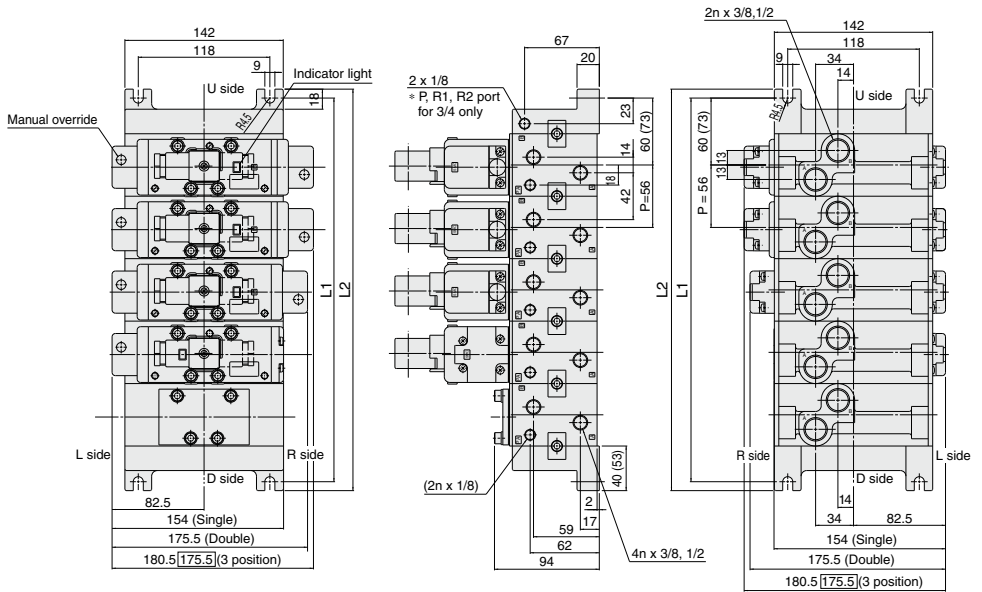

Bottom ported drawing

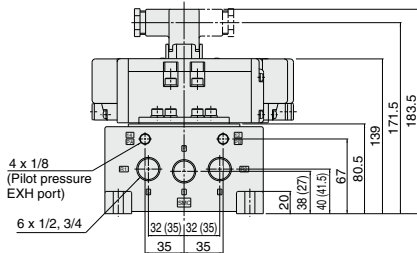

\* ( ) : 3/4  
Dimensions inside □  
are for rubber seals.

### L Dimension

P, R1, R2 port	L	n	L Dimension										Formula
			1	2	3	4	5	6	7	8	9	10	
1/2	L1		120	176	232	288	344	400	456	512	568	624	n: Stations L1 = 56n + 64 L2 = 56n + 80
	L2		136	192	248	304	360	416	472	528	584	640	
3/4	L1		146	202	258	314	370	426	482	538	594	650	n: Stations L1 = 56n + 90 L2 = 56n + 106
	L2		162	218	274	330	386	442	498	554	610	666	

Note) L dimension of SB type with a port size of 1/2 is the same as of SB type with a port size of 3/4.

**Pre-wired Connector Type**

VV72□-□-□□□

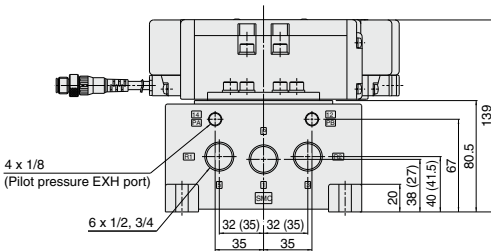
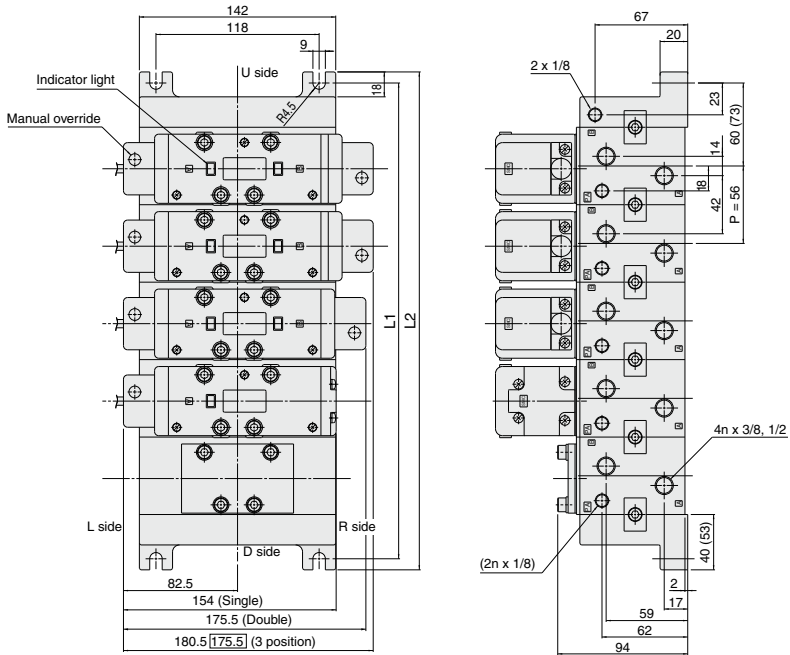

\* ( ) : 3/4  
Dimensions inside □  
are for rubber seals.

**L Dimension**

P, R1, R2 port	L <sup>n</sup>	1	2	3	4	5	6	7	8	9	10	Formula
1/2	L1	120	176	232	288	344	400	456	512	568	624	n: Stations L1 = 56n + 64 L2 = 56n + 80
	L2	136	192	248	304	360	416	472	528	584	640	
3/4	L1	146	202	258	314	370	426	482	538	594	650	n: Stations L1 = 56n + 90 L2 = 56n + 106
	L2	162	218	274	330	386	442	498	554	610	666	

Note) L dimension of SB type with a port size of 1/2 is the same as of SB type with a port size of 3/4.

- SV
- SYJ
- SZ
- VF
- VP4
- VQ 1/2
- VQ 4/5
- VQC 1/2
- VQC 4/5
- VQZ
- SQ
- VFS
- VFR
- VQ7

# VQ7-8 Series

## Manifold Option Parts

### Blanking plate assembly AXT512-9A

It is used by attaching on the manifold block for being prepared for removing a valve for maintenance reasons or planning to mount a spare valve, etc.

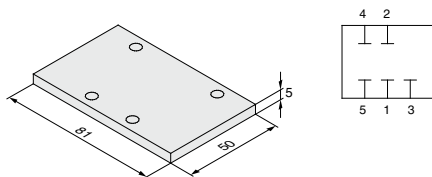

#### Accessory

Description	Part no.	Qty.
Gasket	AXT510-13	1
Bolt	AXT632-54-2	4

### Block plate (For SUP/EXH passages) AXT512-14-1A (For SUP) AXT512-14-2A (For EXH)

When two or more different high pressures are supplied to one manifold, block plates are installed between stations having different pressures. Also, in cases such as when valve exhaust effects other stations in a circuit, block plates are used for exhaust at stations where the exhaust is to be separated.

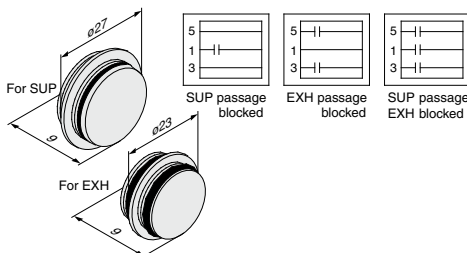

### Individual SUP spacer VV72-P-03

03  
04

By mounting individual SUP spacers on a manifold block, it is possible to provide individual supply ports for each valve.

Thread type

Nil	Rc
F	G
T	NPTF

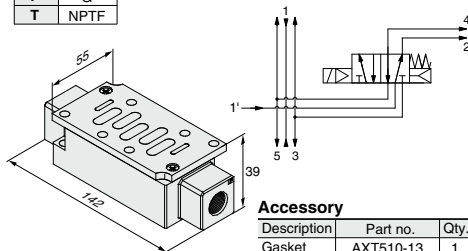

#### Accessory

Description	Part no.	Qty.
Gasket	AXT510-13	1
Bolt	AXT632-54-5	4

### Block plate (For pilot EXH passage) AZ512-49A

When a valve's pilot valve exhaust effects other valves in a circuit, block plates are used between stations where the pilot exhaust passages are to be separated.

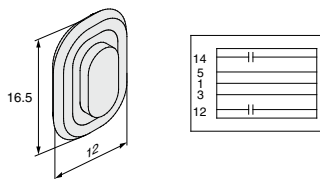

### Individual EXH spacer VV72-R-03

03  
04

By mounting individual EXH spacers on a manifold block, exhaust ports can be provided individually for each valve. (3, 5 common exhaust type)

Thread type

Nil	Rc
F	G
T	NPTF

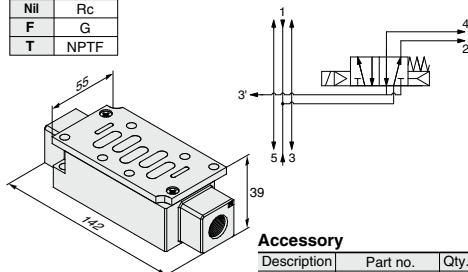

#### Accessory

Description	Part no.	Qty.
Gasket	AXT510-13	1
Bolt	AXT632-54-5	4

### Throttle valve spacer AXT510-32A

A throttle valve spacer is mounted on a manifold block to control cylinder speed by throttling exhaust air flow.

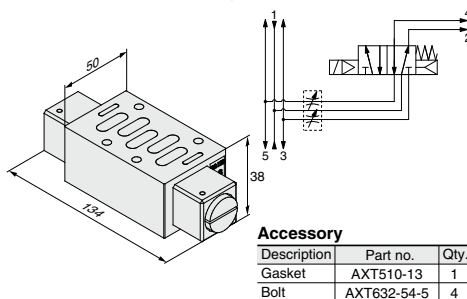

#### Accessory

Description	Part no.	Qty.
Gasket	AXT510-13	1
Bolt	AXT632-54-5	4

### Reverse pressure spacer

**AXT512-19A-**

With reverse pressure control manifold specifications, when pressure is changed individually on one side (ex. high speed cylinder return), pressure can be supplied individually to the R2 side by mounting a reverse pressure spacer. (Port 3 (R2) is individual and 5 (R1) is common.)

● **Thread type**

Nil	Rc
F	G
T	NPTF

● **Port size**

1	3/8
2	1/2

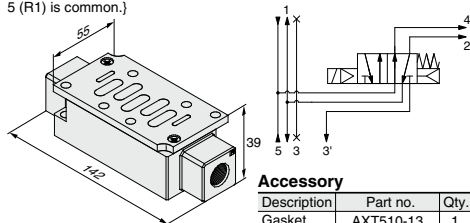

**Accessory**

Description	Part no.	Qty.
Gasket	AXT510-13	1
Bolt	AXT632-54-5	4

### Main EXH back pressure check plate

**AXT512-25A**

In cases where back pressure effects actuator operation due to simultaneous operation of manifold valves, etc., this effect can be eliminated by installing a plate between the manifold block and the valve from which back pressure is to be prevented.

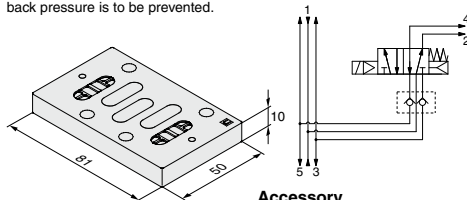

**Accessory**

Description	Part no.	Qty.
Gasket	AXT510-13	1
Bolt	AXT632-54-3	4

### R1/R2 individual EXH spacer

**VV72-R2-04**

By mounting an individual EXH spacer on a manifold block, individual exhaust is possible for both R1 and R2. (3 (R2) and 5 (R1) are individual ports.)

● **Thread type**

Nil	Rc
F	G
T	NPTF

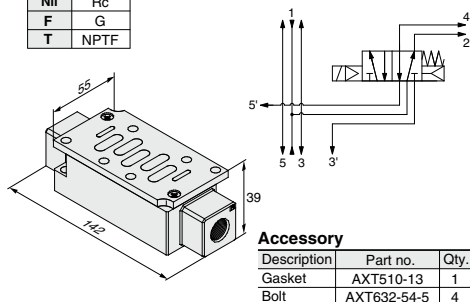

**Accessory**

Description	Part no.	Qty.
Gasket	AXT510-13	1
Bolt	AXT632-54-5	4

### Adapter plate for locked-up cylinder

**AXT602-6A**

When using a locked-up cylinder with 2 valves for control, this spacer can be used by mounting on a manifold block. It consists of a circuit equipped with a function to prevent lurching during release.

● **Thread type**

Nil	Rc 3/8
F	G 3/8
T	NPTF 3/8

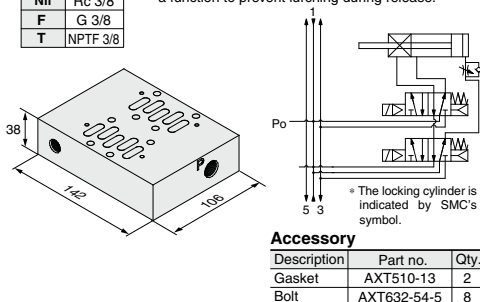

**Accessory**

Description	Part no.	Qty.
Gasket	AXT510-13	2
Bolt	AXT632-54-5	8

### Conversion adapter plate

**VV72-V-1**

This conversion adapter plate allows a VQ7-6 (size 1) valve to be mounted on a VQ7-8 manifold base. (V type)

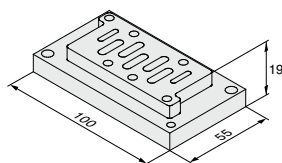

**Accessory**

Description	Part no.	Qty.
Gasket	AXT512-11	1
Bolt	M6 x 20 (With switch)	2
	M4 x 20 (With switch)	2

When a conversion adapter plate is mounted, remove the adapter plate on the manifold block and assemble in the order of gasket and conversion adapter plate.

SV
SYJ
SZ
VF
VP4
VQ 1/2
VQ 4/5
VQC 1/2
VQC 4/5
VQZ
SQ
VFS
VFR
VQ7

# VQ7-8 Series

## Manifold Option Parts

### Release valve spacer

AXT512-17A

Combination of VQ7-8-FG-S (Single) and release valve spacer can be used as air release valve.  
 (Note) Mounting on 2 position double and 3 position valves is not possible.

● Thread type

Nil	Rc(3/8)
F	G(3/8)
T	NPTF(3/8)

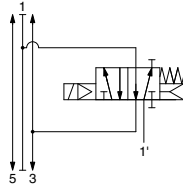
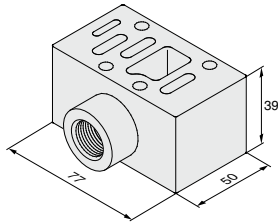

#### Accessory

Description	Part no.	Qty.
Gasket	AXT510-13	1
Bolt	AXT632-54-5	4

### Residual pressure release valve spacer

AZ512-59

At the same time as pilot pressure is released, residual pressure between the cylinder and valve is released.  
 There are two pilot types: internal pilot and external pilot.

● Pilot type

A	Internal pilot
B	External pilot

AZ512-59A

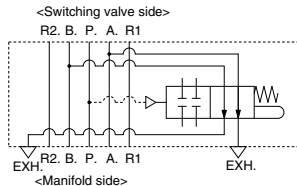
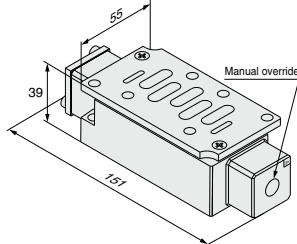

#### Accessory

Description	Part no.	Qty.
Gasket	AXT510-13	1
Bolt	AXT632-54-5	4

AZ512-59B

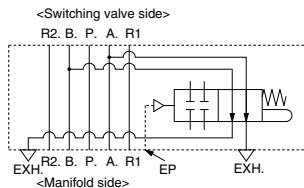
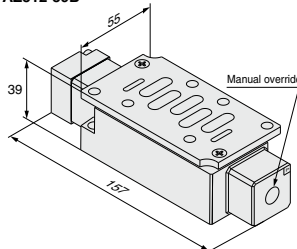

#### Specifications

Model	AZ512-59A	AZ512-59B
Switching signal type (Pilot type)	Internal pilot	External pilot
Applicable solenoid valve	VQ7-8	
Applicable sub-plate	ISO standard size 1	
Max. operating pressure	1.0 MPa	
Min. operating pressure	0.15 MPa (Pressure generated when the valve element is switched to the stopping side.)	
Ambient and fluid temperature	5 to 60°C	
Lubrication	Non-lube (Use turbine oil Class 1 (ISO VG32), if lubricated.)	

**Double check spacer**  
**VV72-FPG**

By combining a 3 position exhaust center valve with a double check spacer, an intermediate stopping position of a cylinder can be held for an extended period. It can also be used for drop prevention at the cylinder stroke end when releasing residual supply pressure, by combining it with a 2 position single or double valve.

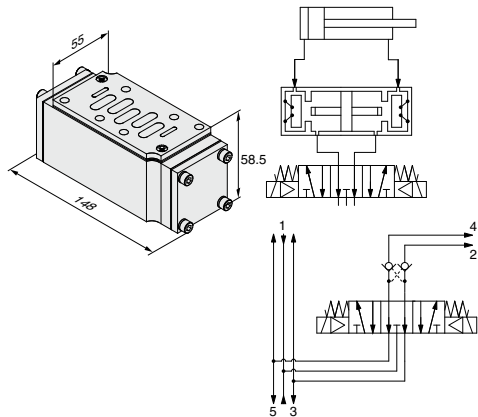

**Caution**

- Since extended cylinder stops are not possible if there are leaks from piping between the valve and cylinder or from fittings, etc., check for leakage using a neutral liquid detergent.
- Since One-touch fittings allow slight air leakage, screw piping is recommended when stopping the cylinder in the middle for a long time.
- Combination of 3 position, closed center and pressure center valves is not possible.
- Set the load weight so that the cylinder side pressure is less than two times the supply side pressure.
- When using the residual pressure release function, confirm the action of actuators, etc., and operate after providing for safety measures.
- Be aware that if the exhaust side of perfect spacer is restricted excessively, the intermediate stopping accuracy will decrease and will lead to improper intermediate stops.
- To combat the effects of back pressure, when required, we recommend installing an individual EXH spacer between the double check spacer and the manifold.

**Silencer box**  
**VV72-□□□-□□-SB**

This can be provided as a unit on the end plate to reduce manifold exhaust noise and piping labor.

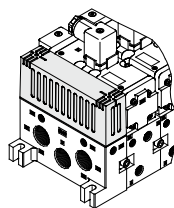

**Interface regulator**

**ARB350-00-<sup>A</sup>/<sub>B</sub>**

Spacer Interface regulators can be placed on top of the manifold block to reduce the pressure of each of the valves.

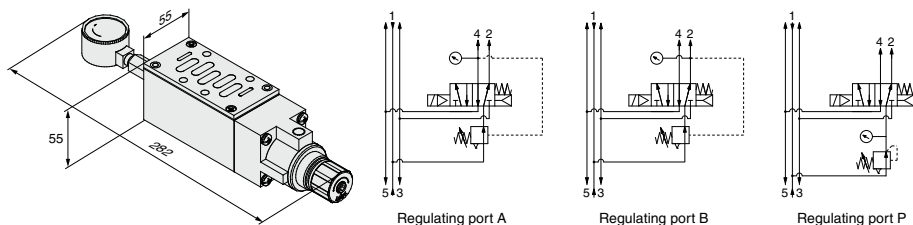

**Accessory**

Description	Part no.	Qty.
Gasket	AXT510-13	1
Bolt	AXT632-54-6	4

**Part No.**

P reduced pressure	ARB350-00-P
A reduced pressure	ARB350-00-A
B reduced pressure	ARB350-00-B

**Caution**

- When combining a pressure center valve and interface regulator with reduced pressure at ports A and B, use model ARB310-<sup>A</sup>/<sub>B</sub>.
- When combining a reverse pressure valve and interface regulator, use model ARB310-<sup>A</sup>/<sub>B</sub>. Further, it cannot be used with reduced pressure at port P.
- When combining a double check valve and an interface regulator, use a manifold or sub-plate as a basis, and stack them in the following order; the perfect spacer → the interface regulator → the valve.
- When a closed center valve is combined with the interface regulator's A, B port regulation, note that it cannot be used for intermediate stops of a cylinder because there is leakage from relief port on the regulator.

SV
SYJ
SZ
VF
VP4
VQ 1/2
VQ 4/5
VQC 1/2
VQC 4/5
VQZ
SQ
VFS
VFR
VQ7

# VQ7-8 Series

## Manifold Option Parts

### Interface regulator

ARB350-00-<sup>P</sup><sub>A</sub><sup>B</sup>

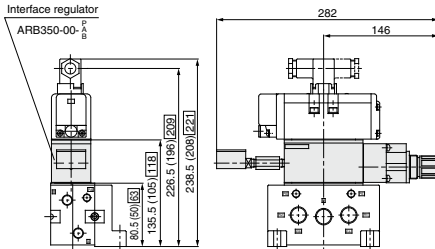

\* Dimensions inside ( ) are for sub-plate aperture 3/8 and 1/2.  
Dimensions inside □ are for sub-plate aperture 3/4.

### Main EXH back pressure check plate AXT512-25A

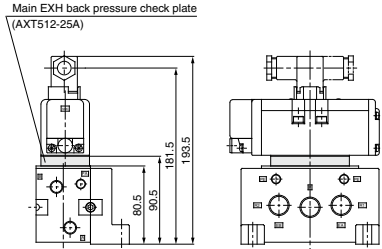

### Throttle valve spacer AXT510-32A

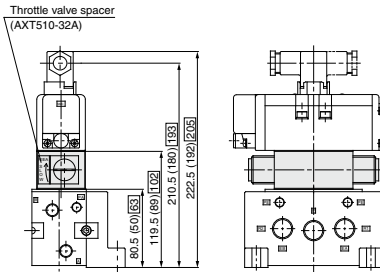

\* Dimensions inside ( ) are for sub-plate aperture 3/8 and 1/2.  
Dimensions inside □ are for sub-plate aperture 3/4.

### Double check spacer VV72-FPG

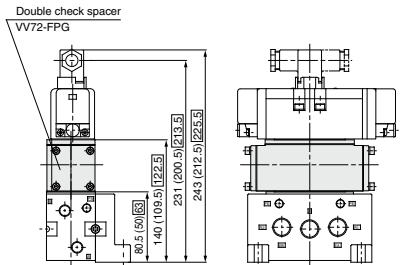

\* Dimensions inside ( ) are for sub-plate aperture 3/8 and 1/2.  
Dimensions inside □ are for sub-plate aperture 3/4.



**Individual EXH spacer**  
**Individual SUP spacer**  
**R1/R2 individual EXH spacer**  
**Reverse pressure spacer**

**VV72-R-03, 04**  
**VV72-P-03, 04**  
**VV72-R2-04**  
**AXT512-19A-<sub>1</sub>**

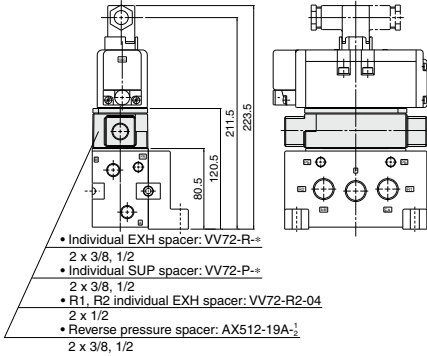

**Silencer box**  
**AXT512-26A**

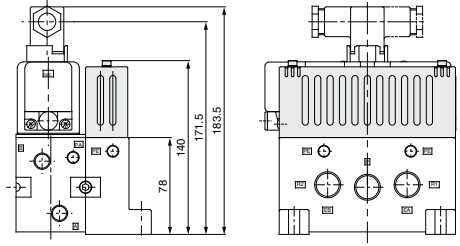

**Spare parts**

Description	Part no.
Element	AXT512-26-2

SV
SYJ
SZ
VF
VP4
VQ 1/2
VQ 4/5
VQC 1/2
VQC 4/5
VQZ
SQ
VFS
VFR
VQ7

**Residual pressure release valve spacer**  
**AZ512-59<sub>A</sub>**

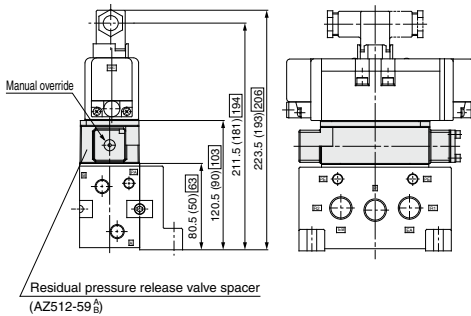

\* Dimensions inside ( ) are for sub-plate aperture 3/8 and 1/2.  
 Dimensions inside [ ] are for sub-plate aperture 3/4.

# VQ7-6/VQ7-8 Series

## Manifold Option Parts/Mounting Bolt Part No.

### VQ7-6 Mounting Bolt Part No.

Number of options		0		Single stack							Double stack			
Mounting bolt	No.	AXT632-45-1	AXT632-45-2	AXT632-45-4	AXT632-45-5	AXT632-45-6	AXT632-45-7	AXT632-45-8	AXT632-45-9	AXT632-45-10	AXT632-45-11	AXT632-45-12	AXT632-45-13	
	Size	M5 x 35 with SW	M5 x 15 with SW	M5 x 45 with SW	M5 x 60 with SW	M5 x 65 with SW	M5 x 70 with SW	M5 x 75 with SW	M5 x 90 with SW	M5 x 95 with SW	M5 x 100 with SW	M5 x 105 with SW	M5 x 115 with SW	
Option mounting diagram														

Number of options		Triple stack				
Mounting bolt	No.	AXT632-45-14	AXT632-45-16	AXT632-45-17	AXT632-45-18	AXT632-45-19
	Size	M5 x 120 with SW	M5 x 130 with SW	M5 x 135 with SW	M5 x 140 with SW	M5 x 145 with SW
Option mounting diagram						

The installation position of spacer (1) in the option mounting diagrams is limited only by the precautions given below.

#### Spacers

- Main EXH back pressure check plate
- Throttle valve spacer
- Release valve spacer
- Spacer (1)
  - Individual SUP spacer
  - Individual EXH spacer
  - R1, R2 individual EXH spacer
  - Reverse pressure spacer
  - Residual pressure release valve spacer
  - Individual SUP spacer with residual pressure release valve
- Spacer (2)
  - Interface regulator (P port regulation)
  - Interface regulator (A port regulation)
  - Interface regulator (B port regulation)
  - Double check spacer
  - Double check spacer with residual pressure release valve

Note 1) A throttle valve spacer and double check spacer (including those with residual pressure release valve) cannot be combined.

Note 2) When a double check spacer (Top) (including those with residual pressure release valve) and individual EXH spacer (Bottom) are combined with a R1, R2 individual EXH spacer (Bottom), be careful regarding the installation position.

Note 3) When an interface regulator (Top) and double check spacer (Bottom) (including those with residual pressure release valve) (Bottom) are combined, be careful regarding the installation position.

### VQ7-8 Mounting Bolt Part No.

Number of options		0		Single stack				Double stack			
Mounting bolt	No.	AXT632-54-1	AXT632-54-2	AXT632-54-3	AXT632-54-5	AXT632-54-6	AXT632-54-7	AXT632-54-8	AXT632-54-9	AXT632-54-10	AXT632-54-11
	Size	M6 x 45 with SW	M6 x 18 with SW	M6 x 55 with SW	M6 x 85 with SW	M6 x 100 with SW	M6 x 105 with SW	M6 x 125 with SW	M6 x 140 with SW	M6 x 145 with SW	M6 x 160 with SW
Option mounting diagram											

Number of options		Triple stack			
Mounting bolt	No.	AXT632-54-12	AXT632-54-13	AXT632-54-14	AXT632-54-15
	Size	M6 x 165 with SW	M6 x 180 with SW	M6 x 185 with SW	M6 x 200 with SW
Option mounting diagram					

#### Spacers

- Main EXH back pressure check plate
- Interface regulator (P port regulation)
- Interface regulator (A port regulation)
- Interface regulator (B port regulation)
- Double check spacer
- Spacer (1)
  - Individual SUP spacer
  - Individual EXH spacer
  - R1, R2 individual EXH spacer
  - Reverse pressure spacer
  - Residual pressure release valve spacer
- Throttle valve spacer
- Release valve spacer

Note 1) A throttle valve spacer and double check spacer cannot be combined.

Note 2) There is no limitation on the mounting position for spacer (1).

Note 3) When a double check spacer (Top) (including those with residual pressure release valve) and individual EXH spacer (Bottom) are combined with a R1, R2 individual EXH spacer (Bottom), be careful regarding the installation position.

Note 4) When an interface regulator (Top) and double check spacer (Bottom) (including those with residual pressure release valve) (Bottom) are combined, be careful regarding the installation position.

**Exploded View of Manifold/VQ7-6**

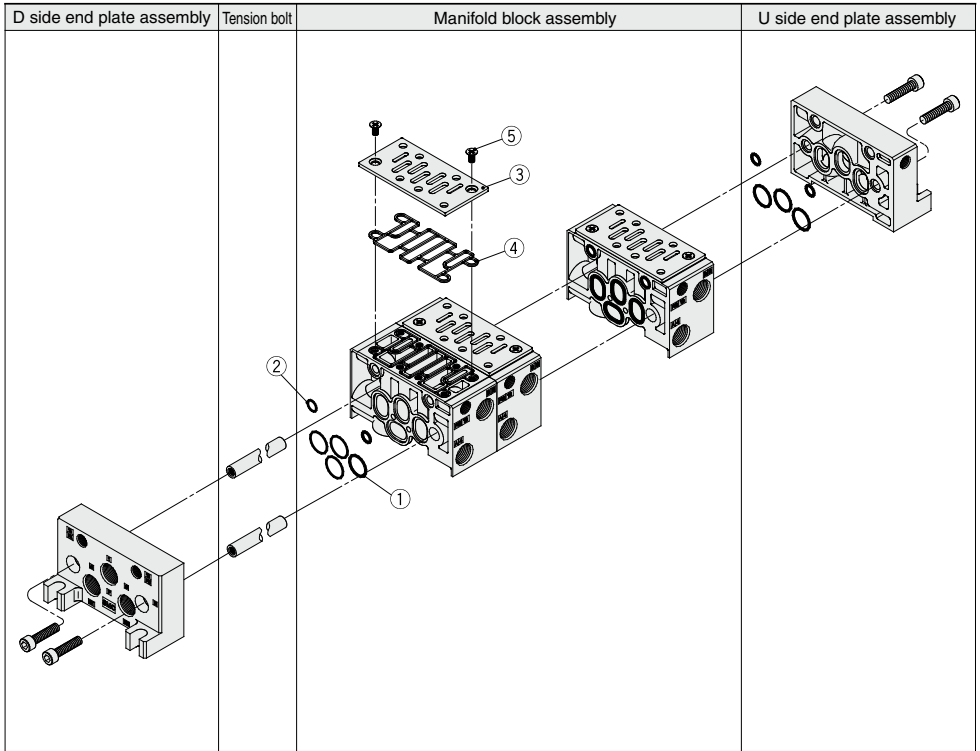

**<End Plate Assembly>**

**AXT502 - [ ] A - [ ] [ ]**

**End plate position**

L	U side
R	D side

**P, R port size**

02	1/4
03	3/8
C12	One-touch fitting for ø12

**Thread type**

Nil	Rc
F	G
T	NPTF

Note) It is not applicable to One-touch fittings.

**<Tension Bolt Part No.>**

**AXT502 - 34 - [ ]**

**Stations**

2	For 2 stations
3	For 3 stations
:	:
10	For 10 stations

Note) These tie-rods are solid pieces for each number of stations.

**<Manifold Block Assembly>**

**AXT502 - 1A - [ ] [ ] [ ] - [ ]**

**Porting specifications**

A	Side
B	Bottom

**Cylinder port location**

L	L side
R	R side

**Cylinder port size**

02	1/4
03	3/8
C6 (1)	One-touch fitting for ø6
C8 (1)	One-touch fitting for ø8
C10 (1)	One-touch fitting for ø10

**Thread type**

Nil	Rc
F	G
T	NPTF

Note) It is not applicable to One-touch fittings.

**Replacement Parts (For manifold block)**

	Part no.	Description	Qty.	Material
1	AXT502-19	O-ring	4	NBR
2	AXT502-20	O-ring	2	NBR
3	AXT502-22-2	Plate	1	SPCC
4	AXT502-31	Gasket	1	NBR
5	M4 x 8	Oval countersunk head screw	2	SWRH

Note 1) Side piping only  
 Note 2) In this manifold block assembly, the tension bolt for increasing station (1 station) is included.

# VQ7-6/VQ7-8 Series

## Exploded View of Manifold/VQ7-8

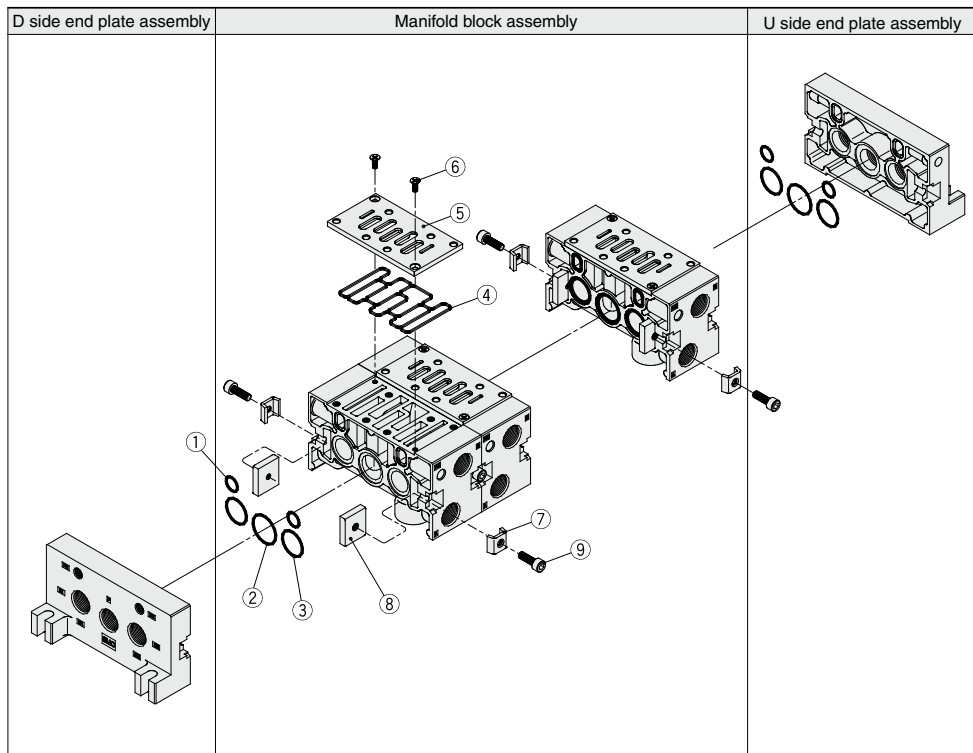

### <End Plate Assembly>

AXT512 -  A -

#### End plate position

L	U side
R	D side

#### Thread type

Nil	Rc
F	G
T	NPTF

Note) It is not applicable to One-touch fittings.

#### P, R port size

04	1/2
06	3/4
C12	One-touch fitting for ø12

### <Manifold Block Assembly>

AXT512 - 1A -    -

#### Porting specifications

A	Side
B	Bottom

#### Cylinder port size

03	3/8
04	1/2

#### Cylinder port location

L	L side
R	R side

#### Thread type

Nil	Rc
F	G
T	NPTF

### Replacement Parts (For manifold block)

Part no.	Description	Qty.	Material
1	AXT512-13	2	NBR
2	AS568-022	1	NBR
3	AS568-020	2	NBR
4	AXT512-5	1	NBR
5	AXT512-4	1	SPCC
6	M4 x 10	2	SWRH
7	AXT512-6-1	2	SPCC
8	AXT512-6-4	2	SS
9	AXT512-6-3	2	SCM



# VQ7-6/VQ7-8 Series Specific Product Precautions 1

Be sure to read this before handling the products.

Refer to back page 50 for Safety Instructions and pages 3 to 9 for 3/4/5 Port Solenoid Valve Precautions.

## Warning

### Manual Override Operation

Since connected equipment will be actuated when the manual override is operated, first confirm that conditions are safe.

Push type is standard. (Tool required)

Push type (Tool required)

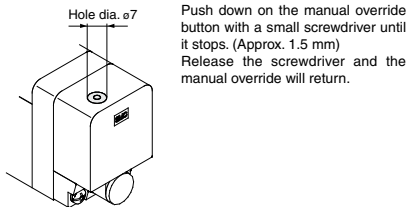

## Caution

### Mounting of Valves

After confirming the gasket is correctly placed under the valve, securely tighten the bolts with the proper torque shown in the table below.

Series	Proper tightening torque (N·m)
VQ7-6	2.3 to 3.7
VQ7-8	4.0 to 6.0

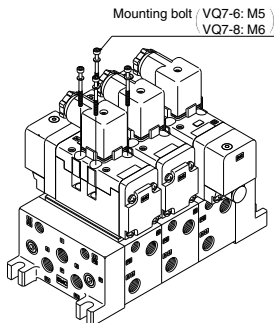

## Caution

### Installation and Removal of Pilot Valve Cover

#### Installation and Removal of Pilot Valve cover

##### ● Removal

To remove the pilot valve cover, spread the cover's hook outward about 1 mm with a flat head screw driver, and pull the cover straight off. If it is pulled off at an angle, the pilot valve may be damaged or the protective O-ring may be scratched.

##### ● Installation

Put the cover back on straight without touching the pilot valve, and push it all the way until the cover's hook locks, without twisting the protective O-ring. (When pushed in, the hook opens and locks automatically.)

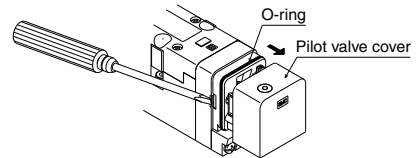

## Caution

### Replacement of Pilot Valves

##### ● Removal

1. Remove the sockets which are installed on the pilot valve pins by pulling them straight upward.
2. Remove the pilot valve mounting screws with a small screwdriver.

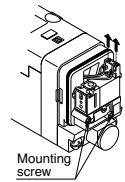

##### ● Installation

1. After confirming installation of the gasket, securely tighten the mounting screws with the proper torque shown in the table below.
2. Put the sockets on straight and install them securely so that the receptacle housings touch the coil surface as shown in the drawing below.

If they are pushed in with excessive force, there is a danger of the sockets coming off of the receptacle housings. Confirm that the sockets do not protrude from the windows on the side of the receptacle housings.

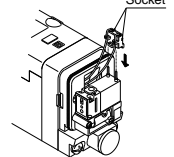

Mounting screw	Proper tightening torque (N·m)
M1.7 x 12	0.12 to 0.13

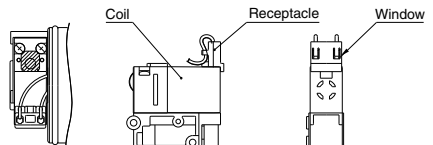

SV  
SYJ  
SZ  
VF  
VP4  
VQ  
1/2  
VQ  
4/5  
VQC  
1/2  
VQC  
4/5  
VQZ  
SQ  
VFS  
VFR  
VQ7



# VQ7-6/VQ7-8 Series Specific Product Precautions 2

Be sure to read this before handling the products.

Refer to back page 50 for Safety Instructions and pages 3 to 9 for 3/4/5 Port Solenoid Valve Precautions.

## Warning

### How to Wire DIN Terminal

ISO#: DIN 43650 A compatible

#### Connection

- Loosen the top screw and remove the connector housing from the terminal spades on the solenoid.
- Remove the housing screw and insert a screwdriver into the slot area on the underside of the DIN cap and carefully separate block and housing.
- Place the terminal screws (slotted screws) on the terminal block, insert the core of the lead wire into the terminal in accordance with the prescribed connection method, and attach securely with the terminal screws.
- Tighten the ground nut to secure the wire.

#### Change of electrical entry (Orientation)

After separating terminal block and housing, the cord entry direction can be changed by attaching the housing in the desired direction (4 directions in 90° increments).

#### Precautions

Pull a connector out vertically, never at an angle.

#### Applicable cable

O.D.:  $\phi 8$  to  $\phi 12$  (When you use the cord longer than  $\phi 9$ , cut the inside of grommet along the cutout and then insert the code.)

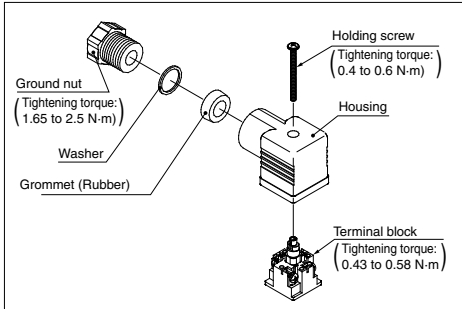

### Using a Pre-wired Connector

4 core wire round type connector (M12) conforming to NECA (Nippon Electric Control Equipment Industries Association) standard 4202

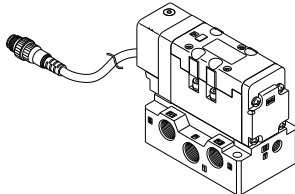

### How to Calculate the Flow Rate

Refer to front matters 42 to 45 for How to Calculate the Flow Rate.

## Caution

### Internal Wiring Specifications

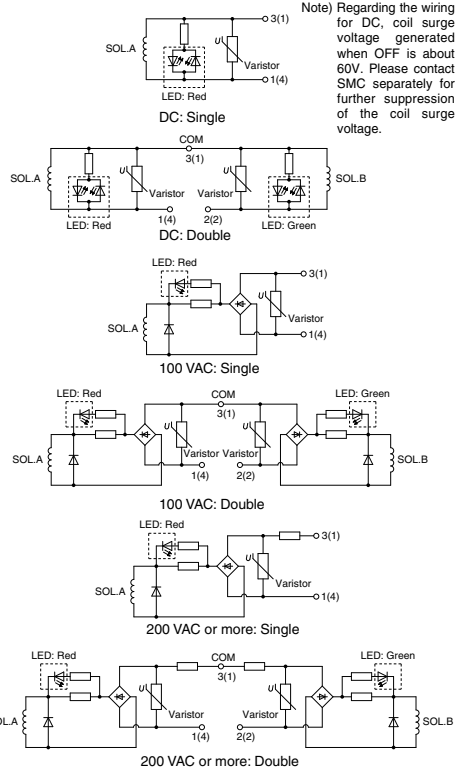

\* Terminal numbers in the circuits are for a DIN connector. Numbers inside ( ) are pre-wired connector pin numbers.

#### DIN terminal wiring specifications

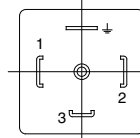

Terminal no.  
1: A side SOL.  
2: B side SOL.  
3: COM terminal

#### Pre-wired connector wiring specifications

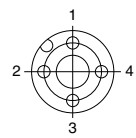

Pin no.  
1: COM. pin  
2: B side SOL.  
3: Not in use  
4: A side SOL.

Note) There is no polarity. It can also be used as -COM.