

# Air Cylinder

## CS2 Series

ø125, ø140, ø160

27.2 kg

Weight

Reduced by Max. **58%**

11.3 kg

CS1

CS2

Standard

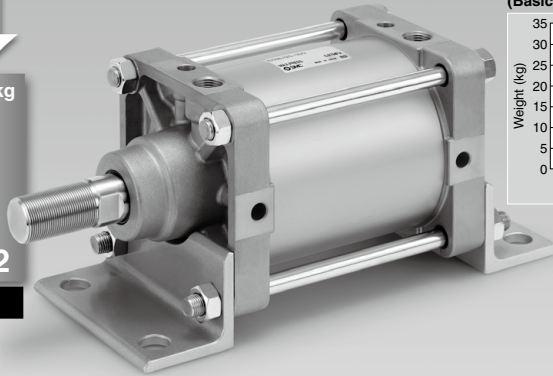

- Lighter installation achieved by reducing weight.
- Die cast rod cover and head cover used to achieve greater weight reduction.
- Rod bore size changed to suit uses, achieving greater weight reduction.

CS1→CS2 Weight Comparison (Basic Type ø160-100st)

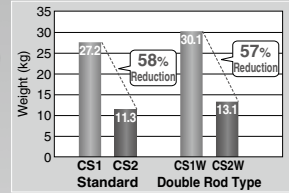

### Maximum stroke when using rotating bracket Expanded by **1.6 times** (compared to the CS1 series)

Lighter cylinder reduces self-weight deflection.  
Stroke range extended to widen use.

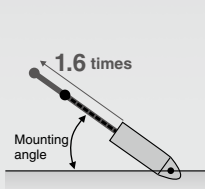

Maximum allowable stroke when using clevis bracket

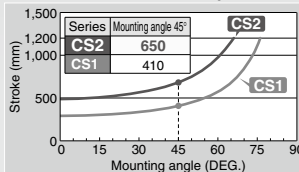

### Allowable lateral load equal to the CS1 series

Even if rod diameter is changed to suit various needs, function remains equal to the CS1 series.

Allowable lateral load of CS1 and CS2

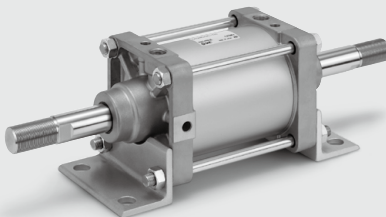
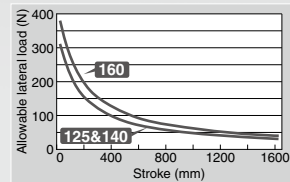

Double Rod Type

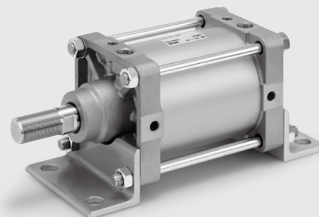

Smooth Cylinder

- CJ1
- CJP
- CJ2
- JCM
- CM2
- CM3
- CG1
- CG3
- JMB
- MB
- MB1
- CA2
- CS1
- CS2

- D-□
- X□
- Technical Data

### Improved operability after installation

Operability has been improved by placing the piping port and cushion valve operation position on the same side.

### Compact auto switches can be mounted

2-color display auto switches can be mounted, enabling precise determination of mounting position, without error.

- Compact auto switches
  - D-M9□
  - D-A9□
- Magnetic field resistant auto switch
  - D-P3DWA

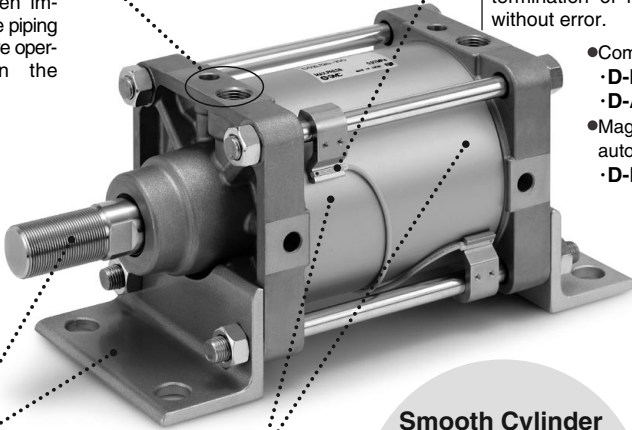

### Interchangeability with the CS1 series

Cylinder mounting dimensions and rod end thread sizes are interchangeable with the CS1 series.

### Cushion seals are now replaceable

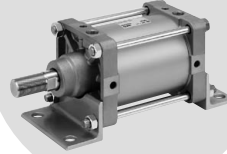

Maintenance improved by making cushion seals replaceable.

### Smooth Cylinder

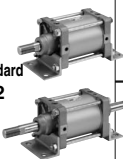

- Minimum operating pressure **0.005 MPa**
- Realize stable, low speed operation at even **5 mm/s**

## Series Variations

Series	Action	Type	Standard variations		Bore size (mm)	Made to Order
			With rod boot	Copper-free		
<b>P.568</b> Standard CS2 	Double acting	Single rod	●	●	125 140 160	<ul style="list-style-type: none"> <li>• Change of rod end shape</li> <li>• Heat-resistant cylinder (0 to 150°C)</li> <li>• Special port positions</li> <li>• With heavy duty scraper</li> <li>• Heat resistant cylinder (0 to 110°C)</li> <li>• Adjustable stroke cylinder/Adjustable retraction type</li> <li>• Dual stroke cylinder/Double rod type</li> <li>• Dual stroke cylinder/Single rod type</li> <li>• Change of trunnion bracket mounting position</li> <li>• Change of tie-rod length</li> <li>• Fluororubber seal</li> <li>• Double clevis pin and double knuckle pin with split pin and flat washer</li> <li>• Double clevis pin and double knuckle pin made of stainless steel</li> <li>• Rod side trunnion mounted on the front of the rod cover</li> <li>• With coil scraper</li> <li>• Made of stainless steel (Piston rod is hard chrome plated)</li> <li>• With rod end bracket</li> </ul>
		Double rod	●	●		
<b>P.583</b> Smooth Cylinder CS2Y 	Double acting	Single rod	●			

# Combination of Standard Products and Made to Order Specifications

## CS2 Series

- : Standard
- ◎ : Made to Order specifications
- : Special product (Contact SMC for details)
- : Not available

Symbol	Specification	Applicable bore size	Series		CS2 (Standard)	CS2Y (Smooth Cylinder)
			Action/Type	Double acting		Double acting
				Single rod	Double rod	Single rod
				Non-lube	Non-lube	
				ø125 to ø160	ø125 to ø160	
Standard	Standard			●	●	●
CDS2	Built-in magnet	ø125 to ø160		●	●	●
CS2□-□ <sup>J</sup> <sub>K</sub>	With rod boot			●	●	●
20-	Copper and Fluorine-free *1			◎	◎	—
-XA□	Change of rod end shape	ø125 to ø160		◎	◎	◎
-XB5	Oversized rod cylinder			○	○	○
-XB6	Heat-resistant cylinder (0 to 150°C)			◎	◎	—
-XB7	Cold-resistant cylinder			○	○	—
-XB9	Low speed cylinder (5 to 50 mm/s)			○	○	○
-XC3	Special port position			◎	○	◎
-XC4	With heavy duty scraper			◎	○	—
-XC5	Heat resistant cylinder (0 to 110°C)			◎	◎	—
-XC6*	Made of stainless steel			Available as *-XC68*		—
-XC7	Tie-rod, cushion valve, tie-rod nut, etc. made of stainless steel			○	○	○
-XC8	Adjustable stroke cylinder/Adjustable extension type			○	—	—
-XC9	Adjustable stroke cylinder/Adjustable retraction type			◎	—	◎
-XC10	Dual stroke cylinder/Double rod type			◎	—	○
-XC11	Dual stroke cylinder/Single rod type			◎	—	○
-XC12	Tandem cylinder			○	—	—
-XC14	Change of trunnion bracket mounting position			◎	◎	◎
-XC15	Change of tie-rod length			◎	◎	◎
-XC22	Fluororubber seal			◎	◎	—
-XC26	Double clevis pin/Double knuckle pin with split pin and flat washer			◎	—	◎
-XC27	Double clevis pin and double knuckle pin made of stainless steel			◎	—	◎
-XC30	Rod side trunnion mounted on the front of the rod cover			◎	◎	◎
-XC35	With coil scraper			◎	◎	—
-XC39	Special trunnion bearing			○	○	○
-XC40	Clevis hole with bushing			○	—	○
-XC50	Knuckle fixed with nut			○	○	○
-XC68	Made of stainless steel (With hard chrome plated piston rod)			◎	◎	◎
-XC86	With rod end bracket			◎	○	◎

The specification of \*-XC6\* made of stainless steel is available as \*-XC68\*.

\*1 For details, refer to the SMC website.

CJ1

CJP

CJ2

JCM

CM2

CM3

CG1

CG3

JMB

MB

MB1

CA2

CS1

CS2

D-□

-X□

Technical Data

# Air Cylinder

# CS2 Series

ø125, ø140, ø160

## How to Order

**CS2 L 125 [ ] - 300 [ ] - [ ]**

**With auto switch** **CDS2 L 125 [ ] - 300 [ ] - M9BW [ ] - [ ]**

**With auto switch (Built-in magnet)**

**Mounting**

<b>B</b>	Basic
<b>L</b>	Foot
<b>F</b>	Rod flange
<b>G</b>	Head flange
<b>C</b>	Single clevis
<b>D</b>	Double clevis
<b>T</b>	Center trunnion

**Bore size**

<b>125</b>	125 mm
<b>140</b>	140 mm
<b>160</b>	160 mm

**Port thread type**

<b>Nil</b>	Rc
<b>TN</b>	NPT
<b>TF</b>	G

**Cylinder stroke (mm)**  
Refer to the page 589 for the "Maximum Stroke" table.

**Made to Order**  
For details, refer to the page 569.

**Number of auto switches**

<b>Nil</b>	2 pcs.
<b>3</b>	3 pcs.
<b>S</b>	1 pc.
<b>n</b>	"n" pcs.

**Auto switch**

<b>Nil</b>	Without auto switch
------------	---------------------

\* Refer to the table below for the applicable auto switch model.

**Suffix for cylinder**

<b>Nil</b>	None
<b>J</b>	Nylon tarpaulin
<b>K</b>	Heat resistant tarpaulin

\* With air cushions on both sides only.

**Built-in Magnet Cylinder Model**

If a built-in magnet cylinder without auto switch is required, there is no need to enter the symbol for auto switch.  
(Example) CDS2B125-200

## Applicable Auto Switches / For detailed auto switch specifications, refer to page 1575 to 1701.

Type	Special function	Electrical entry	Indicator light	Wiring (Output)	Load voltage		Auto switch model		Lead wire length (m)					Pre-wired connector	Applicable load								
					DC	AC	Tie-rod mounting	Band mounting	0.5 (Nil)	1 (M)	3 (L)	5 (Z)											
													24 V			5 V, 12 V	M9N	M9P	M9B	G39	K39	M9NW	M9PW
Solid state auto switch	—	Grommet	—	3-wire (NPN)	24 V	5 V, 12 V	—	M9N	●	●	○	○	○	IC circuit	Relay, PLC								
				3-wire (PNP)				M9P	●	●	○	○	○										
		Terminal conduit	—	2-wire	24 V	12 V	—	M9B	●	●	○	○	○	—									
				3-wire (NPN)				—	G39	—	—	—	—	—									
	Diagnostic indication (2-color indicator)	Grommet	Yes	—	3-wire (NPN)	24 V	5 V, 12 V	—	M9NW	●	●	○	○	○		IC circuit							
					3-wire (PNP)				M9PW	●	●	○	○	○									
					2-wire				M9BW	●	●	○	○	○		—							
					3-wire (NPN)				M9NA*1	○	○	●	○	○		IC circuit							
					3-wire (PNP)				M9PA*1	○	○	●	○	○		—							
					2-wire				M9BA*1	○	○	●	○	○		IC circuit							
Water resistant (2-color indicator)	Grommet	—	—	4-wire (NPN)	24 V	5 V, 12 V	—	F59F	●	—	●	○	○	IC circuit									
				2-wire (Non-polar)				P3DWA	●	●	●	○	—	—									
Reed auto switch	—	Grommet	Yes	3-wire (NPN equivalent)	24 V	5 V	—	A96	●	—	●	—	—	IC circuit	Relay, PLC								
								No	12 V	100 V	A93	●	●	●		—	—	—					
									5 V, 12 V	100 V or less	A90	●	—	●		—	—	IC circuit					
								Yes	Terminal conduit	—	2-wire	24 V	12 V	—		—	A54	●	●	●	—	—	
																	A64	●	—	—	—	—	—
								No	DIN terminal	—	—	24 V	12 V	—		—	A33	—	—	—	—	—	PLC
		A34	—	—	—	—	—								—		—						
		Yes	Grommet	—	—	24 V	—	—	—	A44	—	—	—	—	—	Relay, PLC							
										A59W	●	—	●	—	—	—	—						

\*1 Water resistant type auto switches can be mounted on the above models, but in such case SMC cannot guarantee water resistance. Consult with SMC regarding water resistant types with the above model numbers.

\* Lead wire length symbols: 0.5 m ..... Nil (Example) M9NW 3 m ..... L (Example) M9NWL  
1 m ..... M (Example) M9NWM 5 m ..... Z (Example) M9NWZ

\* Solid state auto switches marked with "○" are produced upon receipt of order.

\* Since there are applicable auto switches other than listed, refer to page 589 for details.

\* For details about auto switches with pre-wired connector, refer to pages 1648 and 1649.

\* D-A9□, M9□, M9□W, M9□A, P3DWA□ are shipped together (but not assembled). (Only auto switch mounting bracket is assembled at the time of shipment.)



**Symbol**

Double acting, air cushion

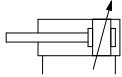

**Made to Order Specifications**  
[Click here for details](#)

Symbol	Specifications
-XA□	Change of rod end shape
-XB6	Heat-resistant cylinder (150°C)
-XC3	Special port position
-XC4	With heavy duty scraper
-XC5	Heat resistant cylinder (110°C)
-XC9	Adjustable stroke cylinder/Adjustable retraction type
-XC10	Dual stroke cylinder/Double rod type
-XC11	Dual stroke cylinder/Single rod type
-XC14	Change of trunnion bracket mounting position
-XC15	Change of tie-rod length
-XC22	Fluororubber seal
-XC26	Double clevis pin/Double knuckle pin with split pin and flat washer
-XC27	Double clevis pin and double knuckle pin made of stainless steel
-XC30	Rod side trunnion mounted on the front of the rod cover
-XC35	With coil scraper
-XC68	Made of stainless steel (With hard chrome plated piston rod)
-XC86	With rod end bracket

**Rod Boot Material**

Symbol	Material	Max. ambient temperature
<b>J</b>	Nylon tarpaulin	70°C
<b>K</b>	Heat resistant tarpaulin	110°C*

\* Maximum ambient temperature for the rod boot itself.

For the specifications of cylinders with auto-switch, please refer to pages 587 to 589.

- Minimum stroke for auto switch mounting
- Auto switch proper mounting position (detection at stroke end) and its mounting height
- Operating range
- Auto switch mounting bracket part no.

**Specifications**

Bore size (mm)	125	140	160
<b>Action</b>	Double acting, Single rod		
<b>Fluid</b>	Air		
<b>Proof pressure</b>	1.57 MPa		
<b>Maximum operating pressure</b>	0.97 MPa		
<b>Minimum operating pressure</b>	0.05 MPa		
<b>Piston speed</b>	50 to 500 mm/s		
<b>Cushion</b>	Air cushion		
<b>Ambient and fluid temperature</b>	Without auto switch	0 to 70°C (No freezing)	
	With auto switch	0 to 60°C (No freezing)	
<b>Lubrication</b>	Not required (Non-lube)		
<b>Stroke length tolerance (mm)</b>	Stroke	Tolerance	
	250 or less	+1.0 0	
	251 to 1000	+1.4 0	
	1001 to 1500	+1.8 0	
	1501 to 1600	+2.2 0	
<b>Mounting</b>	Basic, Foot, Rod flange, Head flange, Single clevis, Double clevis, Center trunnion		

**Maximum Stroke**

Mounting bracket	Maximum stroke (mm)	
	Basic, Head flange, Single clevis, Double clevis, Center trunnion	Foot, Rod flange
<b>125</b>	1000 or less	1600 or less
<b>140</b>		
<b>160</b>	1200 or less	

**Accessory**

Mounting	Basic	Foot	Rod flange	Head flange	Single clevis	Double clevis	Center trunnion
Standard equipment	Clevis pin	—	—	—	—	●	—
Option	Rod end nut	●	●	●	●	●	●
	Single knuckle joint	●	●	●	●	●	●
	Double knuckle joint (Knuckle pin, Split pin)	●	●	●	●	●	●
	Rod boot	●	●	●	●	●	●

\* If using the rod end nut with a single knuckle joint or a double knuckle joint, use the type with rod end bracket (-XC86) or order the accessory separately. For part numbers and dimensions of accessories, refer to page 577.

**Mounting Bracket Part No.**

Bore size (mm)	125	140	160
<b>Foot*</b>	CS2-L12	CS2-L14	CS2-L16
<b>Flange</b>	CS2-F12	CS2-F14	CS2-F16
<b>Single clevis</b>	CS2-C12	CS2-C14	CS2-C16
<b>Double clevis**</b>	CS2-D12	CS2-D14	CS2-D16

\* Order two foot brackets per cylinder.

\*\* When ordering the double clevis type, the clevis pin and 2 split pins are included as accessories.

**CJ1**

**CJP**

**CJ2**

**JCM**

**CM2**

**CM3**

**CG1**

**CG3**

**JMB**

**MB**

**MB1**

**CA2**

**CS1**

**CS2**

**D-□**

**-X□**

Technical Data

## Weight

Bore size (mm)		125	140	160
Basic weight	Basic	5.46	6.50	9.07
	Foot	7.49	9.50	12.45
	Rod flange	8.51	12.03	15.80
	Head flange	8.51	12.03	15.80
	Single clevis	8.53	10.79	14.56
	Double clevis	8.99	11.54	15.41
	Trunnion	9.59	12.23	15.47
Additional weight with magnet (With built-in magnet and auto switch)		0.07	0.07	0.08
Additional weight per each 100 mm of stroke		1.55	1.67	2.23
Accessory bracket	Single knuckle	0.91	1.16	1.56
	Double knuckle (With Knuckle pin, Split pin)	1.37	1.81	2.48
	Rod end nut	0.16	0.16	0.23

Calculation: (Example) **CS2L160-500**

- Basic weight ..... 12.45 (kg)
  - Additional weight ..... 2.23 (kg/100 mm)
  - Cylinder stroke ..... 500 (mm)
- $12.45 + 2.23 \times 500/100 = 23.60$  (kg)

### ⚠ Warning

- Do not use the cylinder as a shock absorber.**  
Using the cylinder as a shock absorber may cause damage.
- Do not open the cushion valve beyond the stopper.**  
As a retaining mechanism for the cushion valve, retaining ring is installed, and the cushion valve should not be opened beyond that point.  
If not operated in accordance with the above precautions, the cushion valve may be ejected from the cover when air pressure is supplied.  
To adjust the cushion valve, use the JIS B 4648 hexagon wrench key 4 (width across flats of cushion valve: 4).
- Use the air cushion at the end of cylinder stroke.**

### ⚠ Caution

- Regarding the installation of a knuckle joint**  
Please contact SMC if a knuckle joint must be installed on the piston rod by using the rod end nut.
- Regarding the screw-in of fittings when piping**  
When ports and fittings are screwed in, tighten them with the proper tightening torque below.

Bore size (mm)	Connecting thread nominal size	Proper tightening torque N·m
<b>125, 140</b>	1/2	28 to 30
<b>160</b>	3/4	

- Do not deform cushion rings when removing and assembling.**  
Cushion rings are press molded products. If a cushion ring bumps with something when removing and assembling, the air cushion may not function properly due to cushion ring deformation.
- Do not place tape or other objects onto the painted surface of the unit.**  
The paint of the CS cylinder is dried naturally, so it may peel off if tape or another object is placed onto it.

## Theoretical Output / Double Acting

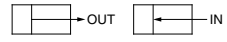

Unit: N

Bore size (mm)	Rod size (mm)	Operating direction	Piston area (mm <sup>2</sup> )	Operating pressure (MPa)								
				0.2	0.3	0.4	0.5	0.6	0.7	0.8	0.9	1.0
125	32	OUT	12300	2460	3690	4920	6150	7380	8610	9840	11100	12300
		IN	11500	2300	3450	4600	5750	6900	8050	9200	10400	11500
140	32	OUT	15400	3080	4620	6160	7700	9240	10800	12300	13900	15400
		IN	14600	2920	4380	5840	7300	8760	10200	11700	13100	14600
160	38	OUT	20100	4020	6030	8040	10100	12100	14100	16100	18100	20100
		IN	19000	3800	5700	7600	9500	11400	13300	15200	17100	19000

### Relation between Cylinder Size and Maximum Stroke

The below table shows the applicable maximum stroke (in cm units), found by calculation assuming the case where the force generated by the cylinder itself acts as buckling force on the piston rod, or piston rod and cylinder tube.

Therefore, it is possible to find the applicable maximum stroke for each cylinder size using the relationship between the size of the operating pressure and the cylinder support type, regardless of the load ratio.

[Reference] If it is stopped with the external stopper on the cylinder extension side, even with a light load, the maximum generated force of the cylinder will act on the cylinder itself.

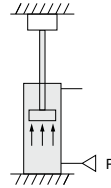

Mounting			Operating pressure (MPa)	Applicable max. stroke according to buckling strength (cm)		
Support bracket nominal symbol and schematic diagram		Nominal symbol		125	140	160
Foot: <b>L</b>	Rod flange: <b>F</b>	Head flange: <b>G</b>	0.3	103	92	113
			0.5	79	70	86
			0.7	66	58	72
			0.3	45	38	47
			0.5	33	27	34
			0.7	26	22	27
			0.3	96	83	106
Clevis: <b>C, D</b>		Center trunnion: <b>T</b>	0.5	71	61	76
			0.7	59	50	62
			0.3	135	119	147
			0.5	101	89	111
			0.7	84	74	91
			0.3	301	267	330
			0.5	231	207	253
			0.7	193	172	212
			0.3	144	126	156
			0.5	109	94	118
			0.7	90	78	97
			0.3	433	386	476
			0.5	334	297	367
			0.7	281	250	309
			0.3	210	185	229
			0.5	160	141	175
			0.7	134	117	129

- CJ1**
- CJP**
- CJ2**
- JCM**
- CM2**
- CM3**
- CG1**
- CG3**
- JMB**
- MB**
- MB1**
- CA2**
- CS1**
- CS2**

- D-□**
- X□**
- Technical Data

# CS2 Series

## Construction

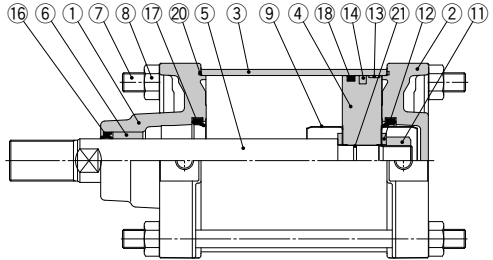
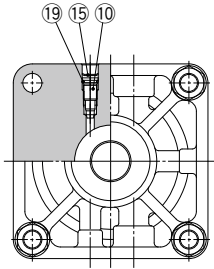

### Component Parts

No.	Description	Material	Note
1	Rod cover	Aluminum die-cast	Chromated
2	Head cover	Aluminum die-cast	Chromated
3	Cylinder tube	Aluminum alloy	Hard anodized
4	Piston	Aluminum alloy	Chromated
5	Piston rod	Carbon steel	Hard chrome plated
6	Bushing	Bearing alloy	
7	Tie-rod	Carbon steel	Zinc chromated
8	Tie-rod nut	Rolled steel	Nickel plated
9	Cushion ring	Stainless steel	
10	Cushion valve	Rolled steel	Nickel plated
11	Piston nut	Carbon steel	Nickel plated
12	Flat washer	Carbon steel	Nickel plated
13	Wear ring	Resin	
14	Magnet*	—	
15	Retaining ring	Spring steel	Phosphate treatment

\* Built-in magnet type with auto switch

### Component Parts

No.	Description	Material	Note
16	Rod seal	NBR	
17	Cushion seal	Urethane	
18	Piston seal	NBR	
19	Valve seal	NBR	
20	Tube gasket	NBR	
21	Piston gasket	NBR	

### Replacement Parts: Seal Kit

Bore size (mm)	Kit no.	Content
125	CS2-125A-PS	Set of nos. above 16, 17, 18, 20.
140	CS2-140A-PS	
160	CS2-160A-PS	

\* Seal kit includes a grease pack (40 g).

Order with the following part number when only the grease pack is needed.

Grease pack part number: GR-S-010 (10 g), GR-S-020 (20 g)



## Dimensions

### Basic: CS2B

With rod boot

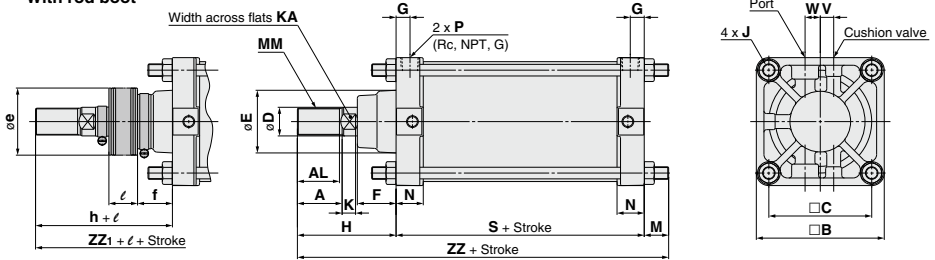

Bore size (mm)	Stroke range (mm)	A	AL	□B	□C	D	E	F	G	J	V	W	K	KA	M	MM
125	Up to 1000	50	47	143	115	32	71	43	15	M14 x 1.5	15	17	15	27	27	M30 x 1.5
140	Up to 1000	50	47	157	128	32	71	43	15	M14 x 1.5	15	17	15	27	27	M30 x 1.5
160	Up to 1200	56	53	177	144	38	78.5	42	18	M16 x 1.5	15	20	17	34	30.5	M36 x 1.5

Bore size (mm)	N	P	S	Without rod boot		With rod boot				
				H	ZZ	e	f	h	ℓ	ZZ1
125	30.5	1/2	98	110	235	75	40	133	1/2 stroke	258
140	30.5	1/2	98	110	235	75	40	133	1/2 stroke	258
160	34.5	3/4	106	120	256.5	75	40	141	1/2 stroke	277.5

\* The minimum stroke with rod boot is 30 mm or more.  
 \*\* For auto switch mounting position and its mounting height, refer to page 587.  
 \*\*\* Refer to "Minimum Stroke for Auto Switch Mounting" on page 588.

### Foot: CS2L

With rod boot

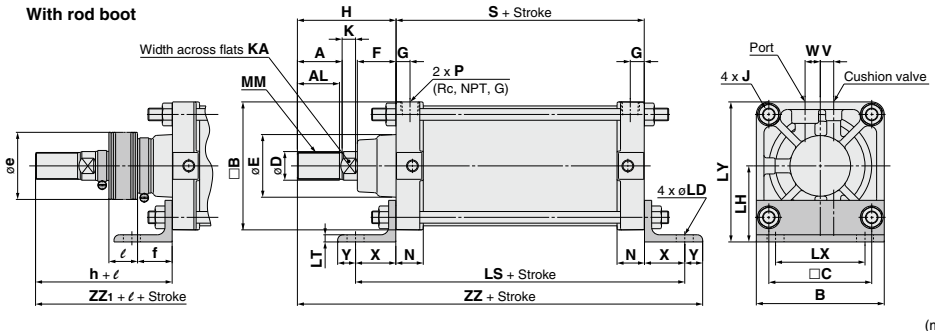

Bore size (mm)	Stroke range (mm)	A	AL	□B	B	□C	D	E	F	G	J	V	W	K	KA	LD	LH	LS
125	Up to 1600	50	47	143	143	115	32	71	43	15	M14 x 1.5	15	17	15	27	19	85	188
140	Up to 1600	50	47	157	157	128	32	71	43	15	M14 x 1.5	15	17	15	27	19	100	188
160	Up to 1600	56	53	177	177	144	38	78.5	42	18	M16 x 1.5	15	20	17	34	19	106	206

Bore size (mm)	LT	LX	LY	MM	N	P	S	X	Y	Without rod boot		With rod boot				
										H	ZZ	e	f	h	ℓ	ZZ1
125	8	100	156.5	M30 x 1.5	30.5	1/2	98	45	20	110	273	75	40	133	1/2 stroke	296
140	9	112	178.5	M30 x 1.5	30.5	1/2	98	45	30	110	283	75	40	133	1/2 stroke	306
160	9	118	194.5	M36 x 1.5	34.5	3/4	106	50	25	120	301	75	40	141	1/2 stroke	322

\* The minimum stroke with rod boot is 30 mm or more.  
 \*\* For auto switch mounting position and its mounting height, refer to page 587.  
 \*\*\* Refer to "Minimum Stroke for Auto Switch Mounting" on page 588.

- CJ1
- CJP
- CJ2
- JCM
- CM2
- CM3
- CG1
- CG3
- JMB
- MB
- MB1
- CA2
- CS1
- CS2

D-□  
 -X□  
 Technical Data

# CS2 Series

## Dimensions

### Rod flange: CS2F

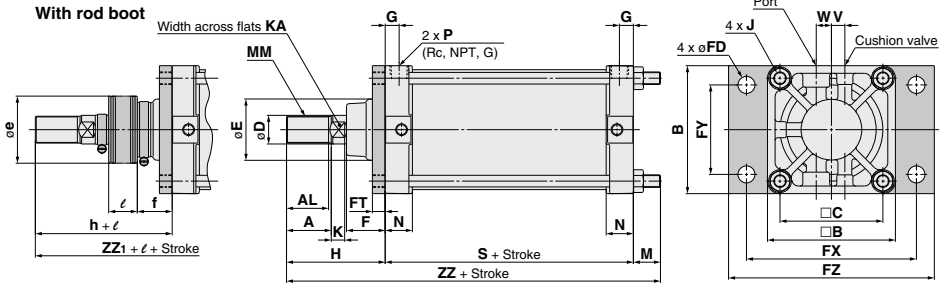

Bore size (mm)	Stroke range (mm)	A	AL	□B	B	□C	D	E	F	FD	FT	FX	FY	FZ	G	J	V
125	Up to 1600	50	47	143	145	115	32	71	43	19	14	190	100	230	15	M14 x 1.5	15
140	Up to 1600	50	47	157	160	128	32	71	43	19	20	212	112	255	15	M14 x 1.5	15
160	Up to 1600	56	53	177	180	144	38	78.5	42	19	20	236	118	275	18	M16 x 1.5	15

Bore size (mm)	W	K	KA	M	MM	N	P	S	Without rod boot				With rod boot			
									H	ZZ	e	f	h	ℓ	ZZ1	
125	17	15	27	13	M30 x 1.5	30.5	1/2	98	110	221	75	40	133	1/2 stroke	244	
140	17	15	27	13	M30 x 1.5	30.5	1/2	98	110	221	75	40	133	1/2 stroke	244	
160	20	17	34	15	M36 x 1.5	34.5	3/4	106	120	241	75	40	141	1/2 stroke	262	

\* The minimum stroke with rod boot is 30 mm or more.

\*\* For auto switch mounting position and its mounting height, refer to page 587.

\*\*\* Refer to "Minimum Stroke for Auto Switch Mounting" on page 588.

### Head flange: CS2G

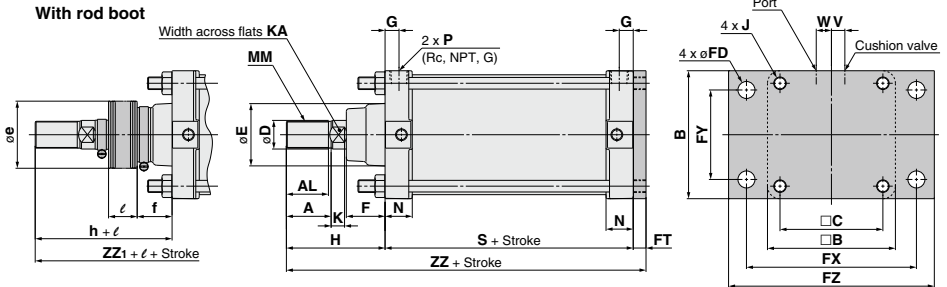

Bore size (mm)	Stroke range (mm)	A	AL	□B	B	□C	D	E	F	FD	FT	FX	FY	FZ	G	J	V
125	Up to 1000	50	47	143	145	115	32	71	43	19	14	190	100	230	15	M14 x 1.5	15
140	Up to 1000	50	47	157	160	128	32	71	43	19	20	212	112	255	15	M14 x 1.5	15
160	Up to 1200	56	53	177	180	144	38	78.5	42	19	20	236	118	275	18	M16 x 1.5	15

Bore size (mm)	W	K	KA	MM	N	P	S	Without rod boot				With rod boot			
								H	ZZ	e	f	h	ℓ	ZZ1	
125	17	15	27	M30 x 1.5	30.5	1/2	98	110	222	75	40	133	1/2 stroke	245	
140	17	15	27	M30 x 1.5	30.5	1/2	98	110	228	75	40	133	1/2 stroke	251	
160	20	17	34	M36 x 1.5	34.5	3/4	106	120	246	75	40	141	1/2 stroke	267	

\* The minimum stroke with rod boot is 30 mm or more.

\*\* For auto switch mounting position and its mounting height, refer to page 587.

\*\*\* Refer to "Minimum Stroke for Auto Switch Mounting" on page 588.

**Dimensions**

**Single clevis: CS2C**

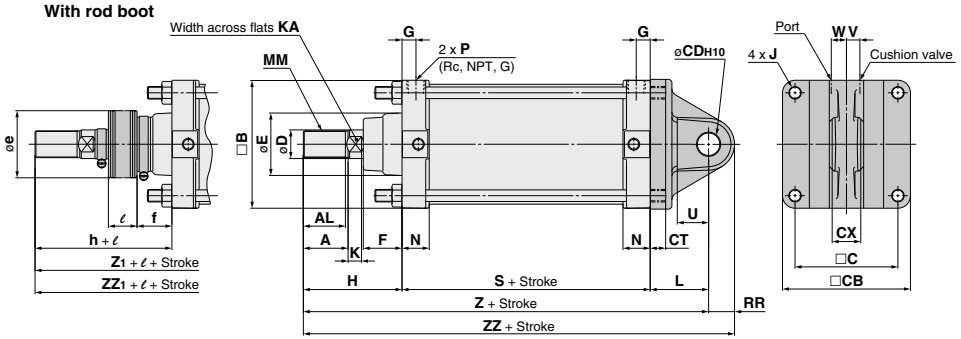

**Double clevis: CS2D**

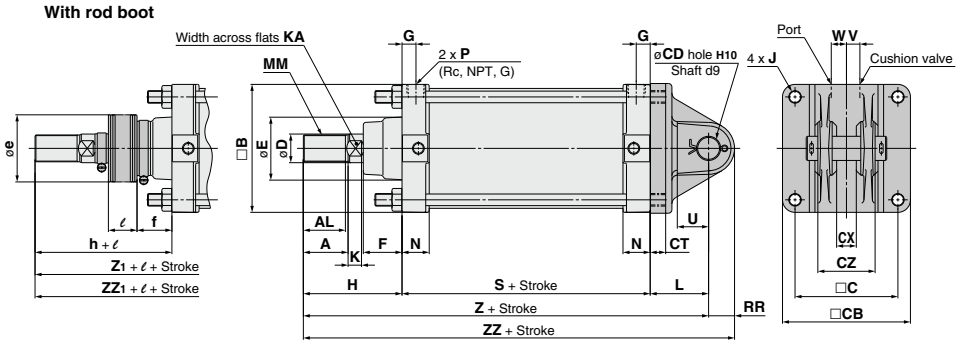

- CJ1**
- CJP**
- CJ2**
- JCM**
- CM2**
- CM3**
- CG1**
- CG3**
- JMB**
- MB**
- MB1**
- CA2**
- CS1**
- CS2**

Bore size (mm)	Stroke range (mm)	A	AL	□B	□C	□CB	CDH10	CT	Single clevis			Double clevis			D	E	F	G	J	V	W
									CX	CX	CZ	CX	CX	CZ							
125	Up to 1000	50	47	143	115	145	25 <sup>+0.084</sup> <sub>0</sub>	17	32 <sup>-0.1</sup> <sub>-0.3</sub>	32 <sup>+0.3</sup> <sub>-0.1</sub>	64 <sup>0</sup> <sub>-0.2</sub>	32	71	43	15	M14 x 1.5	15	17			
140	Up to 1000	50	47	157	128	160	28 <sup>+0.084</sup> <sub>0</sub>	17	36 <sup>-0.1</sup> <sub>-0.3</sub>	36 <sup>+0.3</sup> <sub>-0.1</sub>	72 <sup>0</sup> <sub>-0.2</sub>	32	71	43	15	M14 x 1.5	15	17			
160	Up to 1200	56	53	177	144	180	32 <sup>+0.100</sup> <sub>0</sub>	20	40 <sup>-0.1</sup> <sub>-0.3</sub>	40 <sup>+0.3</sup> <sub>-0.1</sub>	80 <sup>0</sup> <sub>-0.2</sub>	38	78.5	42	18	M16 x 1.5	15	20			

Bore size (mm)	K	KA	L	MM	N	P	S	U	RR	Without rod boot			With rod boot					
										H	Z	ZZ	e	f	h	ℓ	Z1	ZZ1
125	15	27	65	M30 x 1.5	30.5	1/2	98	35	29	110	273	302	75	40	133	1/2 stroke	296	325
140	15	27	75	M30 x 1.5	30.5	1/2	98	40	32	110	283	315	75	40	133	1/2 stroke	306	338
160	17	34	80	M36 x 1.5	34.5	3/4	106	45	36	120	306	342	75	40	141	1/2 stroke	327	363

\* The minimum stroke with rod boot is 30 mm or more.  
 \*\* For auto switch mounting position and its mounting height, refer to page 587.  
 \*\*\* Refer to "Minimum Stroke for Auto Switch Mounting" on page 588.

- D-□**
- X□**
- Technical Data**

# CS2 Series

## Dimensions

### Center trunnion: CS2T

With rod boot

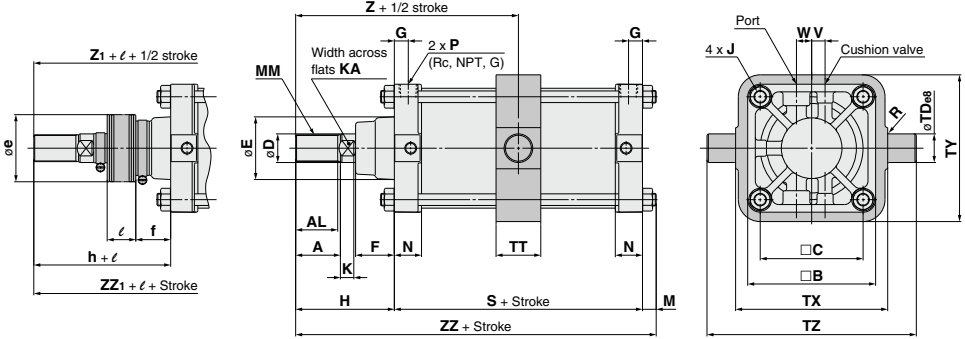

Bore size (mm)	Stroke range (mm)	A	AL	□B	□C	D	E	F	G	J	V	W	K	KA	M	MM	N
125	25 to 1000	50	47	143	115	32	71	43	15	M14 x 1.5	15	17	15	27	13	M30 x 1.5	30.5
140	30 to 1000	50	47	157	128	32	71	43	15	M14 x 1.5	15	17	15	27	13	M30 x 1.5	30.5
160	35 to 1200	56	53	177	144	38	78.5	42	18	M16 x 1.5	15	20	17	34	15	M36 x 1.5	34.5

Bore size (mm)	P	R	S	TD <sub>e8</sub>	TT	TX	TY	TZ	Without rod boot			With rod boot					
									H	Z	ZZ	e	f	h	ℓ	Z <sub>1</sub>	ZZ <sub>1</sub>
125	1/2	1	98	32 <sup>-0.050</sup> <sub>-0.089</sub>	50	170	164	234	110	159	221	75	40	133	1/2 stroke	182	244
140	1/2	1.5	98	36 <sup>-0.050</sup> <sub>-0.089</sub>	55	190	184	262	110	159	221	75	40	133	1/2 stroke	182	244
160	3/4	1.5	106	40 <sup>-0.050</sup> <sub>-0.089</sub>	60	212	204	292	120	173	241	75	40	141	1/2 stroke	194	262

\* The minimum stroke with rod boot is 30 mm or more for ø125, ø140 and 35 mm or more for ø160.

\*\* For auto switch mounting position and its mounting height, refer to page 587.

\*\*\* Refer to "Minimum Stroke for Auto Switch Mounting" on page 588.

CS2 Series

# Accessory Bracket

## I Type Single Knuckle Joint\*

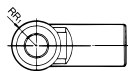
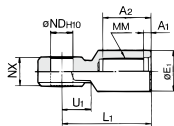

Material: Cast iron

Part no.	Applicable bore size (mm)	A1	A2	E1	L1	MM	ND <sub>H10</sub>	NX	RR1	U1
I-12A	125	8	54	46	100	M30 x 1.5	25 <sup>+0.084</sup> <sub>0</sub>	32 <sup>-0.1</sup> <sub>-0.3</sub>	27	33
I-14A	140	8	54	48	105	M30 x 1.5	28 <sup>+0.084</sup> <sub>0</sub>	36 <sup>-0.1</sup> <sub>-0.3</sub>	30	39
I-16A	160	8	60	55	110	M36 x 1.5	32 <sup>+0.1</sup> <sub>0</sub>	40 <sup>-0.1</sup> <sub>-0.3</sub>	34	39

## Knuckle Pin / Clevis Pin

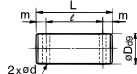

Material: Carbon steel

Part no.	Applicable bore size (mm)	Dø9	L	ℓ	m	d	Applicable split pin
IY-12	125	25 <sup>-0.065</sup> <sub>-0.117</sub>	79.5	69.5	5	4	ø4 x 40
IY-14	140	28 <sup>-0.065</sup> <sub>-0.117</sub>	86.5	76.5	5	4	ø4 x 40
IY-16	160	32 <sup>-0.080</sup> <sub>-0.142</sub>	94.5	84.5	5	4	ø4 x 40

\* Split pin is included.

## Y Type Double Knuckle Joint\*

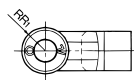
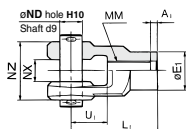

Material: Cast iron

Part no.	Applicable bore size (mm)	A1	E1	L1	MM	ND <sub>H10</sub>	NX	NZ	RR1	U1
Y-12A	125	8	46	100	M30 x 1.5	25 <sup>+0.084</sup> <sub>0</sub>	32 <sup>+0.3</sup> <sub>-0.1</sub>	64 <sup>-0.1</sup> <sub>+0.3</sub>	27	42
Y-14A	140	8	48	105	M30 x 1.5	28 <sup>+0.084</sup> <sub>0</sub>	36 <sup>+0.3</sup> <sub>-0.1</sub>	72 <sup>-0.1</sup> <sub>-0.3</sub>	30	47
Y-16A	160	8	55	110	M36 x 1.5	32 <sup>+0.1</sup> <sub>0</sub>	40 <sup>+0.3</sup> <sub>-0.1</sub>	80 <sup>-0.1</sup> <sub>-0.3</sub>	34	46

## Rod End Nut

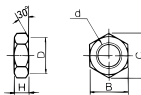

Material: Rolled steel

Part no.	Applicable bore size (mm)	d	H	B	C	D
NT-12	125, 140	M30 x 1.5	18	46	53.1	44
NT-16	160	M36 x 1.5	21	55	63.5	53

- \* Use a single knuckle joint or a double knuckle joint individually. (Screw it entirely over the rod end threads and tighten it.)
- \* Extend the dimensions of A, H, when using a single/double knuckle joint together with a rod end nut. (To extend dimensions A, H, refer to the below table, and specify the product as made-to-order -XA0.)
- \* A pin and split pin are included with the double knuckled joint.

● "Made to order" with rod end bracket (-XC86) is available when ordering cylinders and accessories together. Please refer to page 1855 for details.

## Single/Double Knuckle Joint

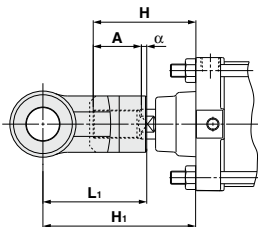

Bore size (mm)	Symbol	H	A	α	L1	H1	Applicable knuckle joint part number	
							I type single knuckle	Y type double knuckle
125		110	50	3.5	100	156.5	I-12A	Y-12A
140		110	50	3.5	105	161.5	I-14A	Y-14A
160		120	56	3.5	110	170.5	I-16A	Y-16A

## A, H Dimensions when Mounting a Single/Double Knuckle Joint together with a Rod End Nut

Bore size (mm)	A	H
125	65	125
140	65	125
160	76	140

CJ1

CJP

CJ2

JCM

CM2

CM3

CG1

CG3

JMB

MB

MB1

CA2

CS1

CS2

D-□

-X□

Technical Data

# Air Cylinder, Double Rod

# CS2W Series

∅125, ∅140, ∅160

## How to Order

**CS2W L 125 [ ] - 100 [ ] - [ ]**

**With auto switch CDS2W L 125 [ ] - 100 [ ] - M9BW [ ] - [ ]**

**With auto switch (Built-in magnet)**

**Double rod type**

**Mounting**

B	Basic
L	Foot
F	Rod flange
T	Center trunnion

**Bore size**

125	125 mm
140	140 mm
160	160 mm

**Port thread type**

Nil	Rc
TN	NPT
TF	G

**Cylinder stroke (mm)**

Refer to page 579 for the "Maximum Stroke" table.

**Made to Order**  
For details, refer to page 579.

**Number of auto switches**

Nil	2 pcs.
3	3 pcs.
S	1 pc.
n	"n" pcs.

**Auto switch**

Nil	Without auto switch
-----	---------------------

\* Refer to the table below for the applicable auto switch model.

**Suffix for cylinder**

Single side rod boot	J	Nylon tarpaulin
Both side rod boot	KK	Heat resistant tarpaulin
Single side rod boot	K	Heat resistant tarpaulin
Both side rod boot	JJ	Nylon tarpaulin

### Built-in Magnet Cylinder Model

If a built-in magnet cylinder without auto switch is required, there is no need to enter the symbol for auto switch.

(Example) CDS2WB125-100

### Applicable Auto Switches / For detailed auto switch specifications, refer to pages 1575 to 1701.

Type	Special function	Electrical entry	Wiring (Output)	Load voltage		Auto switch model		Lead wire length (m)			Pre-wired connector	Applicable load			
				DC	AC	Tie-rod mounting	Band mounting	0.5 (Nil)	1 (M)	3 (L)			5 (Z)		
Solid state auto switch	—	Grommet	3-wire (NPN)	24 V	5 V, 12 V	—	M9N	●	●	●	○	IC circuit	Relay, PLC		
			3-wire (PNP)				12 V	M9P	●	●	●			○	
		Terminal conduit	2-wire	24 V	5 V, 12 V	—	G39	—	—	—	—	IC circuit			
			3-wire (NPN)				12 V	M9NW	●	●	●			○	
	Diagnostic indication (2-color indicator)	Grommet	3-wire (NPN)	24 V	5 V, 12 V	—	M9PW	●	●	●	○	IC circuit			
			3-wire (PNP)				12 V	M9BW	●	●	●			○	
		Water resistant (2-color indicator)	Grommet	3-wire (NPN)	24 V	5 V, 12 V	—	M9NA*1	—	○	●	○		IC circuit	
				3-wire (PNP)				12 V	M9PA*1	—	○	●			○
			Diagnostic indication (2-color indicator)	Terminal conduit	2-wire	24 V	12 V	—	M9BA*1	—	○	●		○	IC circuit
					4-wire (NPN)				5 V, 12 V	F59F	●	●		●	
Magnetic field resistant (2-color indicator)	Grommet	2-wire (Non-polar)	24 V	—	—	P3DWA	—	●	●	●	IC circuit				
		3-wire (NPN equivalent)				5 V	A96	●	●	●		○			
Reed auto switch	—	Grommet	2-wire	24 V	12 V	100 V	A93	●	●	●	—	IC circuit	Relay, PLC		
							No	5 V, 12 V	A90	●	●			●	—
							Yes	100 V or less	A54	●	●			●	—
							No	100 V, 200 V	A54	●	●			●	—
							Yes	200 V or less	A64	●	●			●	—
		Terminal conduit	Yes	2-wire	24 V	12 V	100 V, 200 V	—	A33	—	—	—	—	—	PLC
									A34	—	—	—	—		
									A44	—	—	—	—		
									A59W	●	●	●	—		
									A59W	●	●	●	—		

\*1 Water resistant type auto switches can be mounted on the above models, but in such case SMC cannot guarantee water resistance. Consult with SMC regarding water resistant types with the above model numbers.

\* Lead wire length symbols: 0.5 m ..... Nil (Example) M9NW 3 m ..... L (Example) M9NWL  
1 m ..... M (Example) M9NWM 5 m ..... Z (Example) M9NWZ

\* Solid state auto switches marked with "○" are produced upon receipt of order.

\* Since there are applicable auto switches other than listed, refer to page 589 for details.

\* For details about auto switches with pre-wired connector, refer to pages 1648 and 1649.

\* D-A9□, M9□, M9□A, P3DWA□ are shipped together (but not assembled). (Only auto switch mounting bracket is assembled at the time of shipment.)

## Specifications



### Symbol

Double acting, air cushion

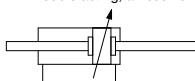

## Rod Boot Material

Symbol	Material	Max. ambient temperature
J	Nylon tarpaulin	70°C
K	Heat resistant tarpaulin	110°C*

\* Maximum ambient temperature for the rod boot itself.

## Minimum Stroke for Auto Switch Mounting

For details on the minimum number of strokes required for mounting, please refer to the "Minimum Stroke for Auto Switch Mounting" table on page 588.

## Made to Order Specifications

[Click here for details](#)

Symbol	Specifications
-XA□	Change of rod end shape
-XB6	Heat-resistant cylinder (150°C)
-XC4	With heavy duty scraper
-XC5	Heat resistant cylinder (110°C)
-XC14	Change of trunnion bracket mounting positions
-XC15	Change of tie-rod length
-XC22	Fluororubber seal
-XC30	Rod side trunnion mounted on the front of the rod cover
-XC35	With coil scraper
-XC68	Made of stainless steel (With hard chrome plated piston rod)

For the specifications of cylinders with auto-switch, please refer to pages 587 to 589.

- Minimum stroke for auto switch mounting
- Auto switch proper mounting position (detection at stroke end) and its mounting height
- Operating range
- Auto switch mounting bracket part no.

Bore size (mm)	125	140	160
Action	Double acting, Double rod		
Fluid	Air		
Proof pressure	1.57 MPa		
Maximum operating pressure	0.97 MPa		
Minimum operating pressure	0.05 MPa		
Piston speed	50 to 500 mm/s		
Cushion	Air cushion		
Ambient and fluid temperature	Without auto switch	0 to 70°C (No freezing)	
	With auto switch	0 to 60°C (No freezing)	
Lubrication	Not required (Non-Lube)		
Stroke length tolerance	250 or less <sup>st</sup> · <sup>+1.0</sup> / <sub>0</sub> , 251 to 1,000 <sup>st</sup> · <sup>+1.4</sup> / <sub>0</sub> , 1,001 to 1,200 <sup>st</sup> · <sup>+1.8</sup> / <sub>0</sub>		
Mounting	Basic, Foot, Rod flange, Head flange, Center trunnion		

## Maximum Stroke

Bore size	Maximum stroke (mm)
125	1000 or less
140	
160	1200 or less

## Accessory

Mounting		Basic	Foot	Rod flange	Center trunnion
Option	Rod end nut	●	●	●	●
	Single knuckle joint	●	●	●	●
	Double knuckle joint (Knuckle pin, Split pin)	●	●	●	●
	Rod boot	●	●	●	●

\* If using the rod end nut together with a single knuckle joint and a double knuckle joint, please refer to page 577.

## Mounting Bracket Part No.

Bore size (mm)	125	140	160
Foot*	CS2-L12	CS2-L14	CS2-L16
Flange	CS2-F12	CS2-F14	CS2-F16

\* Order two foot brackets per cylinder.

## Weight / Aluminum tube: Lube type

Bore size (mm)		125	140	160
Basic weight	Basic	6.36	7.54	9.93
	Foot	8.39	10.54	13.31
	Rod flange	9.41	13.07	16.66
	Trunnion	10.49	13.27	16.33
	Additional weight with magnet (With built-in magnet and auto switch)	0.07	0.07	0.08
Additional weight per 100 mm of stroke		2.18	2.30	3.11
Accessory bracket	Single knuckle	0.91	1.16	1.56
	Double knuckle joint (Knuckle pin, Split pin)	1.37	1.81	2.48
	Rod end nut	0.16	0.16	0.23

Calculation: (Example) **CS2WL160-500**

- Basic weight ..... 13.31 (kg)
- Additional weight ..... 3.11 (kg/100 mm)
- Cylinder stroke ..... 500 (mm)
- 13.31 + 3.11 x 500/100 = 28.86 (kg)

CJ1

CJP

CJ2

JCM

CM2

CM3

CG1

CG3

JMB

MB

MB1

CA2

CS1

CS2

D-□

-X□

Technical Data

# CS2W Series

## Construction

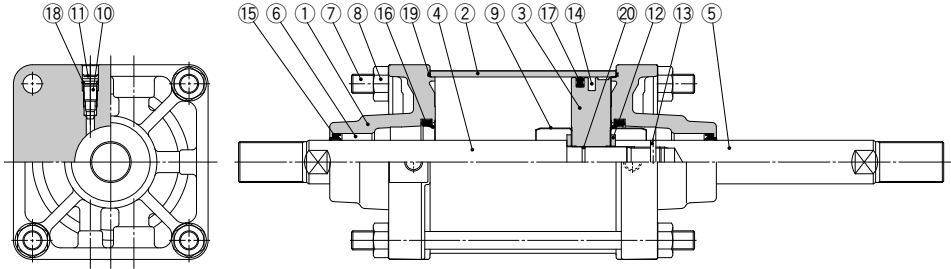

### Component Parts

No.	Description	Material	Note
1	Rod cover	Aluminum die-cast	Chromated
2	Cylinder tube	Aluminum alloy	Hard anodized
3	Piston	Aluminum alloy	Chromated
4	Piston rod A	Carbon steel	Hard chrome plated
5	Piston rod B	Carbon steel	Hard chrome plated
6	Bushing	Bearing alloy	
7	Tie-rod	Carbon steel	Zinc chromated
8	Tie-rod nut	Rolled steel	Nickel plated
9	Cushion ring	Stainless steel	
10	Cushion valve	Rolled steel	Nickel plated
11	Retaining ring	Spring steel	Phosphate treatment
12	Flat washer	Carbon steel	Nickel plated
13	Pin	Spring steel	Phosphate treatment
14	Magnet*	—	

\* Built-in magnet type with auto switch

### Component Parts

No.	Description	Material	Note
15	Rod seal	NBR	
16	Cushion seal	Urethane	
17	Piston seal	NBR	
18	Valve seal	NBR	
19	Tube gasket	NBR	
20	Piston gasket	NBR	

### Replacement Parts: Seal Kit

Bore size (mm)	Kit no.	Content
125	CS2W125A-PS	Set of nos. above 15, 16, 17, 19.
140	CS2W140A-PS	
160	CS2W160A-PS	

\* Seal kit includes a grease pack (40 g).

Order with the following part number when only the grease pack is needed.

**Grease pack part number: GR-S-010 (10 g), GR-S-020 (20 g)**



**Dimensions**

**Basic: CS2WB**

**With rod boot (One side)**

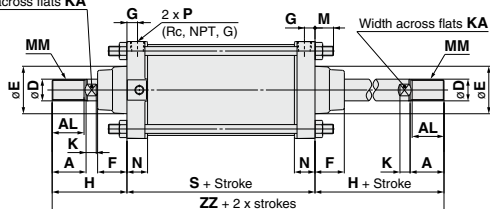
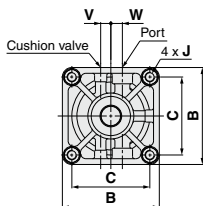
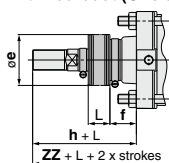

**With rod boot (Both sides)**

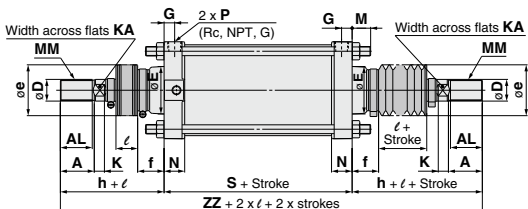
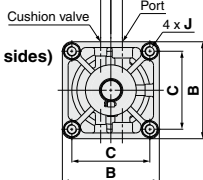

Bore size (mm)	Stroke range (mm)	A	AL	B	C	D	E	F	G	J	V	W	K	KA	M	MM	N	P	S
ø125	Up to 1000	50	47	143	115	32	71	43	15	M14 x 1.5	15	17	15	27	27	M30 x 1.5	30.5	1/2	98
ø140	Up to 1000	50	47	157	128	32	71	43	15	M14 x 1.5	15	17	15	27	27	M30 x 1.5	30.5	1/2	98
ø160	Up to 1200	56	53	177	144	38	78.5	42	18	M16 x 1.5	15	20	17	34	30.5	M36 x 1.5	34.5	3/4	106

Bore size (mm)	(mm)							
	Without rod boot	With rod boot (single side)				(Both sides)		
	H	ZZ	e	f	h	ℓ	ZZ	ZZ
ø125	110	318	75	40	133	1/2 stroke	341	364
ø140	110	318	75	40	133	1/2 stroke	341	364
ø160	120	346	75	40	141	1/2 stroke	367	388

\* The minimum stroke with rod boot is 30 mm or more.  
 \*\* For auto switch mounting position and its mounting height, refer to page 587.  
 \*\*\* Refer to "Minimum Stroke for Auto Switch Mounting" on page 588.

**Foot: CS2WL**

**With rod boot**

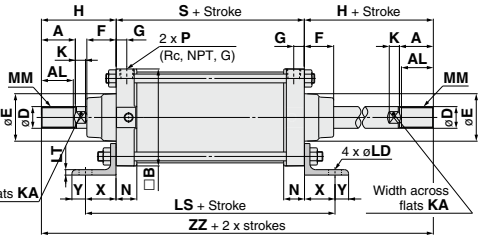
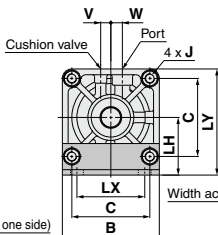
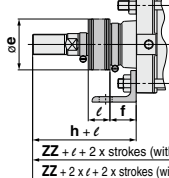

Bore size (mm)	Stroke range (mm)	A	AL	B	B	C	D	E	F	G	J	V	W	K	KA	LD	LH	LS	LT	LX	LY
ø125	Up to 1000	50	47	143	143	115	32	71	43	15	M14 x 1.5	15	17	15	27	19	85	188	8	100	156.5
ø140	Up to 1000	50	47	157	157	128	32	71	43	15	M14 x 1.5	15	17	15	27	19	100	188	9	112	178.5
ø160	Up to 1200	56	53	177	177	144	38	78.5	42	18	M16 x 1.5	15	20	17	34	19	106	206	9	118	194.5

Bore size (mm)	(mm)													
	Without rod boot	With rod boot (Single side)				(Both sides)								
	MM	N	P	S	X	Y	H	ZZ	e	f	h	ℓ	ZZ	ZZ
ø125	M30 x 1.5	30.5	1/2	98	45	20	110	318	75	40	133	1/2 stroke	341	364
ø140	M30 x 1.5	30.5	1/2	98	45	30	110	318	75	40	133	1/2 stroke	341	364
ø160	M36 x 1.5	34.5	3/4	106	50	25	120	346	75	40	141	1/2 stroke	367	388

\* The minimum stroke with rod boot is 30 mm or more.  
 \*\* For auto switch mounting position and its mounting height, refer to page 587.  
 \*\*\* Refer to "Minimum Stroke for Auto Switch Mounting" on page 588.

- CJ1
- CJP
- CJ2
- JCM
- CM2
- CM3
- CG1
- CG3
- JMB
- MB
- MB1
- CA2
- CS1
- CS2

- D-□
- X□
- Technical Data

# CS2W Series

## Dimensions

### Rod flange: CS2WF

#### With rod boot

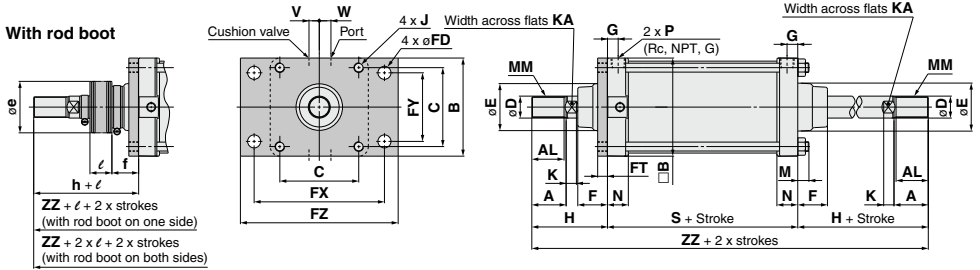

Bore size (mm)	Stroke range (mm)	A	AL	B	B	C	D	E	F	FD	FT	FX	FY	FZ	G	J	V	W	K	KA	M
ø125	Up to 1000	50	47	143	145	115	32	71	43	19	14	190	100	230	15	M14 x 1.5	15	17	15	27	13
ø140	Up to 1000	50	47	157	160	128	32	71	43	19	20	212	112	255	15	M14 x 1.5	15	17	15	27	13
ø160	Up to 1200	56	53	177	180	144	38	78.5	42	19	20	236	118	275	18	M16 x 1.5	15	20	17	34	15

Bore size (mm)	MM	N	P	S	Without rod boot		With rod boot (Single side)							Both sides	
					H	ZZ	e	f	h	ℓ	ZZ	ZZ			
ø125	M30 x 1.5	30.5	1/2	98	110	318	75	40	133	1/2 stroke	341	364			
ø140	M30 x 1.5	30.5	1/2	98	110	318	75	40	133	1/2 stroke	341	364			
ø160	M36 x 1.5	34.5	3/4	106	120	346	75	40	141	1/2 stroke	367	388			

\* The minimum stroke with rod boot is 30 mm or more.  
 \*\* For auto switch mounting position and its mounting height, refer to page 587.  
 \*\*\* Refer to "Minimum Stroke for Auto Switch Mounting" on page 588.

### Center trunnion: CS2WT

#### With rod boot

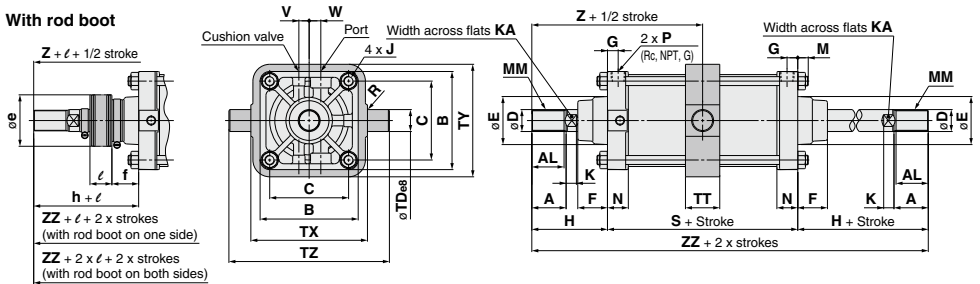

Bore size (mm)	Stroke range (mm)	A	AL	B	C	D	E	F	G	J	V	W	K	KA	M	MM	N	P	R	S
ø125	25 to 1000	50	47	143	115	32	71	43	15	M14 x 1.5	15	17	15	27	13	M30 x 1.5	30.5	1/2	1	98
ø140	30 to 1000	50	47	157	128	32	71	43	15	M14 x 1.5	15	17	15	27	13	M30 x 1.5	30.5	1/2	1.5	98
ø160	35 to 1200	56	53	177	144	38	78.5	42	18	M16 x 1.5	15	20	17	34	15	M36 x 1.5	34.5	3/4	1.5	106

Bore size (mm)	TD <sub>ø8</sub>	TT	TX	TY	TZ	Without rod boot		With rod boot (Single side)							Both sides	
						H	Z	ZZ	e	f	h	ℓ	Z	ZZ	ZZ	
ø125	32 <sup>-0.050</sup> <sub>-0.089</sub>	50	170	164	234	110	159	318	75	40	133	1/2 stroke	182	341	364	
ø140	36 <sup>-0.050</sup> <sub>-0.089</sub>	55	190	184	262	110	159	318	75	40	133	1/2 stroke	182	341	364	
ø160	40 <sup>-0.050</sup> <sub>-0.089</sub>	60	212	204	292	120	173	346	75	40	141	1/2 stroke	194	367	388	

\* The minimum stroke with rod boot is 30 mm or more for ø125, ø140, and 35 mm or more for ø160.  
 \*\* For auto switch mounting position and its mounting height, refer to page 587.  
 \*\*\* Refer to "Minimum Stroke for Auto Switch Mounting" on page 588.

# Smooth Cylinder

# CS2Y Series

∅125, ∅140, ∅160

## How to Order

**With auto switch** **CS2Y L 160** - **300** - **M9BW** -

**With auto switch**  
(Built-in magnet)

**Smooth Cylinder**

**Mounting**

B	Basic
L	Foot
F	Rod flange
G	Head flange
C	Single clevis
D	Double clevis
T	Center trunnion

**Bore size**

125	125 mm
140	140 mm
160	160 mm

**Port thread type**

Nil	Rc
TN	NPT
TF	G

**Cylinder stroke (mm)**

Refer to page 584 for the "Maximum Stroke" table.

**Number of auto switches**

Nil	2 pcs.
S	1 pc.
3	3 pcs.
n	"n" pcs.

**Made to Order**  
For details, refer to page 584.

**Auto switch**

Nil	Without auto switch
-----	---------------------

\* Refer to the table below for the applicable auto switch model.

**Suffix for cylinder**

Rod boot	J	Nylon tarpaulin
	K	Heat resistant tarpaulin
With/without cushion	A	With double-side cushion
	R	With rod cushion
	H	With head cushion
	Nil	Without cushion

\* When more than one symbol is specified, indicate them in alphabetical order.

### Built-in Magnet Cylinder Model

If a built-in magnet cylinder without auto switch is required, there is no need to enter the symbol for auto switch.  
(Example) CDS2YL125-200

### Applicable Auto Switches / For detailed auto switch specifications, refer to pages 1575 to 1701.

Type	Special function	Electrical entry	Indicating light	Wiring (Output)	Load voltage		Auto switch model		Lead wire length (m)				Pre-wired connector	Applicable load				
					DC	AC	Tie-rod mounting	Band mounting	0.5 (Nil)	1 (M)	3 (L)	5 (Z)						
Solid state auto switch	—	Grommet	No	3-wire (NPN)	24 V	5 V, 12 V	—	M9N	●	●	○	○	—	IC circuit				
				3-wire (PNP)				M9P	●	●	○	○						
		Terminal conduit	Yes	2-wire	24 V	5 V, 12 V	—	M9B	●	●	○	○	—	—				
				3-wire (NPN)				—	G39	—	—	—			—	IC circuit		
	Diagnostic indication (2-color indicator)	Grommet	Yes	3-wire (NPN)	24 V	5 V, 12 V	—	M9NW	●	●	○	○	—	IC circuit				
				3-wire (PNP)				M9PW	●	●	○	○						
				2-wire				M9BW	●	●	○	○			—	—		
				3-wire (NPN)				M9NA*1	—	○	○	●					○	
				3-wire (PNP)				M9PA*1	—	○	○	●					○	
				2-wire				M9BA*1	—	○	○	●					○	
Water resistant (2-color indicator)	Grommet	No	4-wire (NPN)	24 V	5 V, 12 V	—	F59F	●	○	○	○	—	IC circuit					
			2-wire (Non-polar)				P3DWA	—	●	—	●			○	—			
Reed auto switch	—	Grommet	Yes	3-wire (NPN equivalents)	24 V	5 V	—	A96	—	●	—	●	—	—	IC circuit			
				12 V				A93	—	●	—	●	—					
				5 V, 12 V				A90	—	●	—	●	—					
				100 V, 200 V				A54	—	●	—	●	—					
				100 V or less				A64	—	●	—	●	—					
		Terminal conduit	Yes	No	2-wire	24 V	12 V	—	—	A33	—	—	—	—	—	PLC		
										100 V, 200 V	A34	—	—	—			—	
										—	A44	—	—	—			—	
										—	A59W	—	●	—			●	—
										—	A59W	—	●	—			●	—

\*1 Water resistant type auto switches can be mounted on the above models, but in such case SMC cannot guarantee water resistance. Consult with SMC regarding water resistant types with the above model numbers.

\* Lead wire length symbols: 0.5 m ..... Nil (Example) M9NW 3 m ..... L (Example) M9NWL  
1 m ..... M (Example) M9NWM 5 m ..... Z (Example) M9NWZ

\* Solid state auto switches marked with "○" are produced upon receipt of order.

\* Since there are applicable auto switches other than listed, refer to page 589 for details.

\* For details about auto switches with pre-wired connector, refer to pages 1648 and 1649.

\* D-A9□, M9□, M9□W, M9□A, P3DWA□ are shipped together (but not assembled). (Only auto switch mounting bracket is assembled at the time of shipment.)

CJ1

CJP

CJ2

JCM

CM2

CM3

CG1

CG3

JMB

MB

MB1

CA2

CS1

CS2

D-□

-X□

Technical Data

# CS2Y Series

**Designed with a low sliding resistance of the piston, this air cylinder is ideal for applications such as contact pressure control, which requires smooth movements at low pressure.**

## Low sliding resistance

Min. operating pressure — 0.005 MPa

## Auto switch mounting is possible

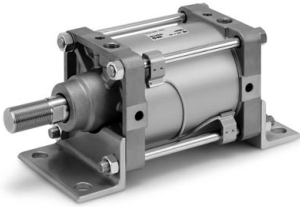

### Symbol

Double acting, without cushion

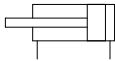

### Made to Order specifications

[Click here for details](#)

Symbol	Specifications
-XA□	Change of rod end shape
-XC3	Special port position
-XC9	Adjustable stroke cylinder/Adjustable retraction type
-XC14	Change of trunnion bracket mounting position
-XC15	Change of tie-rod length
-XC26	Double clevis pin/Double knuckle pin with split pin and flat washer
-XC27	Double clevis pin and double knuckle pin made of stainless steel
-XC30	Rod side trunnion mounted on the front of the rod cover
-XC68	Made of stainless steel (With hard chrome plated piston rod)
-XC86	With rod end bracket

For the specifications of cylinders with auto-switch, please refer to pages 587 to 589.

- Minimum stroke for auto switch mounting
- Auto switch proper mounting position (detection at stroke end) and its mounting height
- Operating range
- Auto switch mounting bracket part no.

## Application Example

Low friction cylinder is used in combination with precision regulator (Series IR).

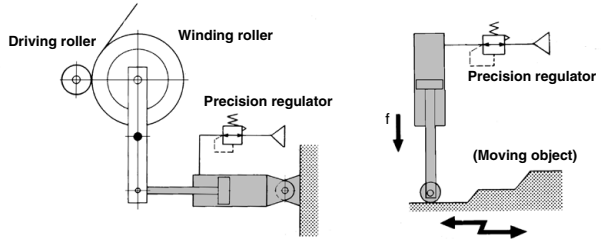

## Specifications

Bore size (mm)	125	140	160
<b>Action</b>	Double acting, Single rod		
<b>Direction of low friction</b>	Both directions		
<b>Fluid</b>	Air		
<b>Proof pressure</b>	1.05 MPa		
<b>Maximum operating pressure</b>	0.7 MPa		
<b>Minimum operating pressure</b>	0.005 MPa*		
<b>Piston speed</b>	5 to 500 mm/s		
<b>Ambient and fluid temperature</b>	Without auto switch	0 to 70°C (No freezing)	
	With auto switch	0 to 60°C (No freezing)	
<b>Allowable leakage</b>	Less than 0.5 L/min (ANR)		
<b>Cushion</b>	Without cushion** (manufacturable with cushion)		
<b>Lubrication</b>	Not required (Non-lube)		
<b>Mounting</b>	Basic, Foot, Rod flange, Head flange, Single clevis, Double clevis, Center trunnion		

\* If a cushion is used, this value will not include the operating pressure within the cushion stroke.

\*\* If an air cushion is not used, set the energy at the stroke end to 0.36J (ø125, ø140) or less, 0.3J (ø160) or less.

## Maximum Stroke

Mounting bracket Bore size (mm)	(mm)	
	Basic, Head flange, Single clevis, Double clevis, Center trunnion	Foot, Rod flange
125	1000 or less	1600 or less
140		
160	1200 or less	1600 or less

## Accessory

Mounting		Basic	Foot	Rod flange	Head flange	Single clevis	Double clevis	Center trunnion
Standard equipment	Clevis pin	—	—	—	—	—	●	—
	Rod end nut	●	●	●	●	●	●	●
Option	Single knuckle joint	●	●	●	●	●	●	●
	Double knuckle joint (Knuckle pin, Split pin)	●	●	●	●	●	●	●
	Rod boot	●	●	●	●	●	●	●

### Mounting Bracket Part No.

Bore size (mm)	125	140	160
Foot*	CS2-L12	CS2-L14	CS2-L16
Flange	CS2-F12	CS2-F14	CS2-F16
Single clevis	CS2-C12	CS2-C14	CS2-C16
Double clevis**	CS2-D12	CS2-D14	CS2-D16

\* Order two foot brackets per cylinder.

\*\* When ordering the double clevis type, the clevis pin and 2 split pins are included as accessories.

### Weight

Bore size (mm)		125	140	160
Basic weight	Basic	5.46	6.50	9.07
	Foot	7.49	9.50	12.45
	Rod flange	8.51	12.03	15.80
	Head flange	8.51	12.03	15.80
	Single clevis	8.53	10.79	14.56
	Double clevis	8.99	11.54	15.41
	Trunnion	9.59	12.23	15.47
Additional weight with magnet (With built-in magnet and auto switch)		0.07	0.07	0.08
Additional weight per each 100 mm of stroke		1.55	1.67	2.23
Accessory bracket	Single knuckle	0.91	1.16	1.56
	Double knuckle (With Knuckle pin, Split pin)	1.37	1.81	2.48
	Rod end nut	0.16	0.16	0.23

Calculation: (Example) **CS2Y160-500**

- Basic weight ..... 12.45 (kg)
  - Additional weight ..... 2.23 (kg/100 mm)
  - Cylinder stroke ..... 500 (mm)
- 12.45 + 2.23 x 500/100 = 23.60 (kg)

### Sliding Resistance

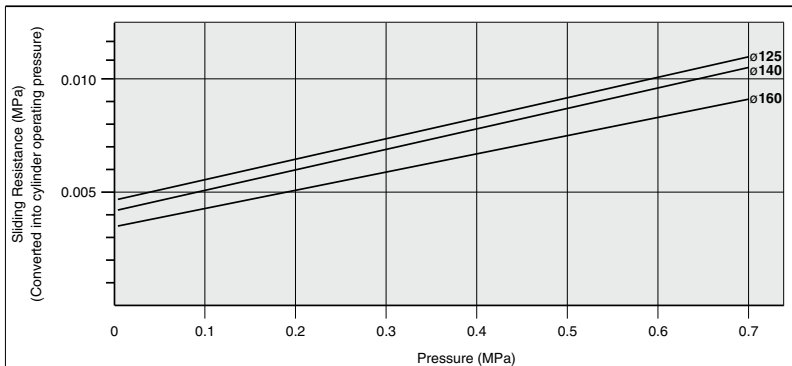

### Rod Boot Material

Symbol	Material	Max. ambient temperature
J	Nylon tarpaulin	70°C
K	Heat resistant tarpaulin	110°C*

\* Maximum ambient temperature for the rod boot itself.

CJ1

CJP

CJ2

JCM

CM2

CM3

CG1

CG3

JMB

MB

MB1

CA2

CS1

CS2

D-□

-X□

Technical Data

# CS2Y Series

## Construction

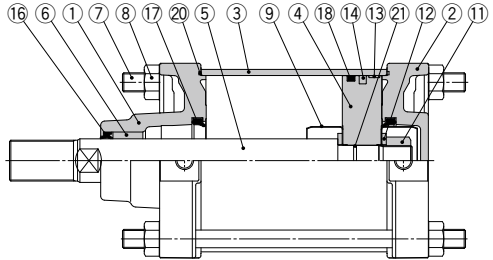
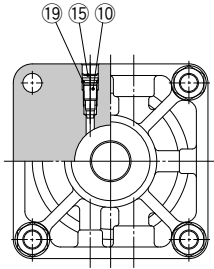

### Component Parts

No.	Description	Material	Note
1	Rod cover	Aluminum die-cast	Chromated
2	Head cover	Aluminum die-cast	Chromated
3	Cylinder tube	Aluminum alloy	Hard anodized
4	Piston	Aluminum alloy	Chromated
5	Piston rod	Carbon steel	Hard chrome plated
6	Bushing	Bearing alloy	
7	Tie-rod	Carbon steel	Zinc chromated
8	Tie-rod nut	Rolled steel	Nickel plated
9	Cushion ring	Stainless steel	
10	Cushion valve	Rolled steel	Nickel plated
11	Piston nut	Carbon steel	Nickel plated
12	Flat washer	Carbon steel	Nickel plated
13	Wear ring	Resin	
14	Magnet*	—	
15	Retaining ring	Spring steel	Phosphate treatment
16	Rod seal	NBR	
17	Cushion seal**	Urethane	
18	Piston seal	NBR	
19	Valve seal	NBR	
20	Tube gasket	NBR	
21	Piston gasket	NBR	

\* For types with built-in magnet or with auto switch.  
 \*\* Used with cushion only.

### Replacement Parts: Seal kit.

Bore size (mm)	Kit no.	Content
125	CS2Y125A-PS	Without cushion
140	CS2Y140A-PS	Consists of Component Part Numbers 16, 18, and 20
160	CS2Y160A-PS	
125	CS2Y125AA-PS	With single-side cushion
140	CS2Y140AA-PS	Consists of Component Part Numbers 16, 17 (two), 18, and 20
160	CS2Y160AA-PS	
125	CS2Y125AR-PS	With single-side cushion
140	CS2Y140AR-PS	Consists of Component Part Numbers 16, 17 (one), 18 and 20.
160	CS2Y160AR-PS	

\* Seal kit does not include a grease pack.  
 Order with the following part number when only the grease pack is needed.  
**Grease pack part number:** GR-L-005 (5 g), GR-L-010 (10 g), GR-L-150 (150g)

### Dimensions

The dimensions and accessories are the same as the CS2 standard type. Refer to pages 573 to 577.

# Auto Switch Mounting 1

## Auto Switch Proper Mounting Position (Detection at stroke end) and Its Mounting Height

### <Band mounting>

- D-A3□ type
- D-G3/K3 type

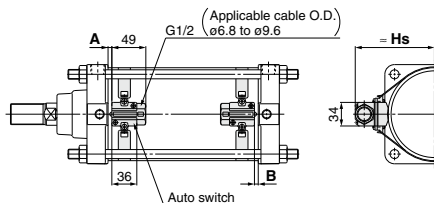

### D-A44 type

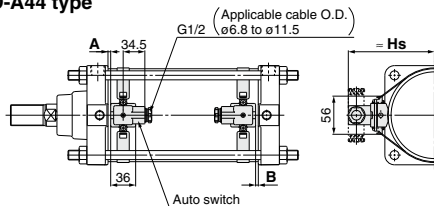

\* The indicator light faces the inside.

### <Tie-rod mounting>

- D-M9□/M9□V type
- D-M9□W/M9□WV type
- D-M9□A/M9□AV type
- D-A9□/A9□V type
- D-Z7□/Z80 type
- D-Y59□/Y69□/Y7P/Y7PV type
- D-Y7□W/Y7□WV type
- D-Y7BA type

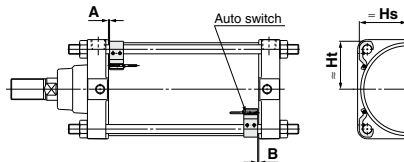

### D-A5□/A6□ type

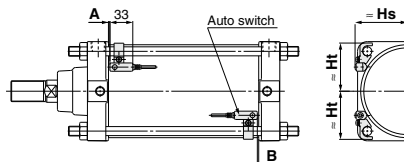

- D-F5□/J59/D-F5NT type
- D-F5BAL/F59F type
- D-F5□W/J59W type

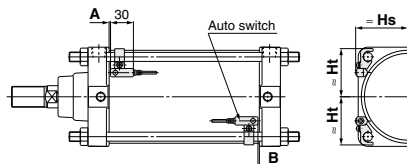

### D-P3DWA type

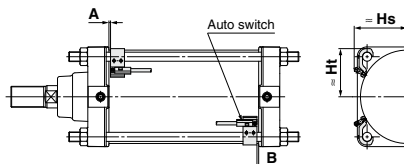

### Auto Switch Proper Mounting Position

Auto switch model	D-M9□ D-M9□V D-M9□W D-M9□WV D-M9□A D-M9□AV		D-A9□ D-A9□V		D-Z7□/Z80 D-Y5□/Y6□ D-Y7P/Y7PV D-Y7□W D-Y7□WV D-Y7BA		D-A5□ D-A6□ D-A3□ D-A44 D-G39 D-K39		D-A59W		D-F5□W D-J59W D-F5BA D-F5□ D-J59 D-F59F		D-F5NT		D-P3DWA	
	A	B	A	B	A	B	A	B	A	B	A	B	A	B	A	B
Bore size 125	13	12	9	8	6.5	5.5	3	2	7	6	9.5	8.5	14.5	13.5	8.5	7.5
140	13	12	9	8	6.5	5.5	3	2	7	6	9.5	8.5	14.5	13.5	8.5	7.5
160	13	12	9	8	6.5	5.5	3	2	7	6	9.5	8.5	14.5	13.5	8.5	7.5

\* Provided as guidelines for auto switch proper mounting position (detection at stroke end). When setting an auto switch, confirm the operation and adjust its mounting position.

### Auto Switch Mounting Height

Auto switch model	D-M9□ D-M9□W D-M9□A D-A9□ D-A9□V		D-M9□V D-M9□WV D-M9□AV		D-Z7□/Z80 D-Y5□/Y6□ D-Y7P D-Y7PV D-Y7□W D-Y7□WV D-Y7BA		D-A3□ D-G39 D-K39		D-A44		D-A5□ D-A6□ D-A59W		D-F5□ D-J59 D-F5□W D-J59W D-F5BA D-F59F D-F5NT		D-P3DWA	
	Hs	Ht	Hs	Ht	Hs	Ht	Hs	Ht	Hs	Ht	Hs	Ht	Hs	Ht	Hs	Ht
Bore size 125	69	69.5	71.5	69.5	69	69.5	116		126		75.5	69.5	74.5	70	76	69.5
140	76	76	77.5	76	76	76	124		134		81	76.5	80	76.5	82	76
160	85	85	86	85	85	85	134.5		144.5		89	87.5	88	87.5	91	85

CJ1

CJP

CJ2

JCM

CM2

CM3

CG1

CG3

JMB

MB

MB1

CA2

CS1

CS2

D-□

-X□

Technical Data

# Auto Switch Mounting 2

## Minimum Stroke for Auto Switch Mounting

n: Number of auto switches (mm)

Auto switch model	Number of auto switches mounted	Mounting brackets other than center trunnion	Center trunnion		
			ø125	ø140	ø160
D-M9□ D-M9□W	With 2 pcs. (Different surfaces, Same surface), With 1 pc.	15	105	110	115
	With n pcs.	$15 + 40 \frac{(n-2)}{2}$ (n = 2, 4, 6, 8... Note 1)	$105 + 40 \frac{(n-4)}{2}$ (n = 4, 8, 12, 16... Note 2)	$110 + 40 \frac{(n-4)}{2}$ (n = 4, 8, 12, 16... Note 2)	$115 + 40 \frac{(n-4)}{2}$ (n = 4, 8, 12, 16... Note 2)
D-M9□V D-M9□WV	With 2 pcs. (Different surfaces, Same surface), With 1 pc.	10	80	85	90
	With n pcs.	$10 + 30 \frac{(n-2)}{2}$ (n = 2, 4, 6, 8... Note 1)	$80 + 30 \frac{(n-4)}{2}$ (n = 4, 8, 12, 16... Note 2)	$85 + 30 \frac{(n-4)}{2}$ (n = 4, 8, 12, 16... Note 2)	$90 + 30 \frac{(n-4)}{2}$ (n = 4, 8, 12, 16... Note 2)
D-M9□A	With 2 pcs. (Different surfaces, Same surface), With 1 pc.	20	115	120	
	With n pcs.	$20 + 40 \frac{(n-2)}{2}$ (n = 2, 4, 6, 8... Note 1)	$115 + 40 \frac{(n-4)}{2}$ (n = 4, 8, 12, 16... Note 2)	$120 + 40 \frac{(n-4)}{2}$ (n = 4, 8, 12, 16... Note 2)	
D-M9□AV	With 2 pcs. (Different surfaces, Same surface), With 1 pc.	15	90	95	
	With n pcs.	$15 + 30 \frac{(n-2)}{2}$ (n = 2, 4, 6, 8... Note 1)	$90 + 30 \frac{(n-4)}{2}$ (n = 4, 8, 12, 16... Note 2)	$95 + 30 \frac{(n-4)}{2}$ (n = 4, 8, 12, 16... Note 2)	
D-A9□	With 2 pcs. (Different surfaces, Same surface), With 1 pc.	15	100	105	110
	With n pcs.	$15 + 40 \frac{(n-2)}{2}$ (n = 2, 4, 6, 8... Note 1)	$100 + 40 \frac{(n-4)}{2}$ (n = 4, 8, 12, 16... Note 2)	$105 + 40 \frac{(n-4)}{2}$ (n = 4, 8, 12, 16... Note 2)	$110 + 40 \frac{(n-4)}{2}$ (n = 4, 8, 12, 16... Note 2)
D-A9□V	With 2 pcs. (Different surfaces, Same surface), With 1 pc.	10	75	80	85
	With n pcs.	$10 + 30 \frac{(n-2)}{2}$ (n = 2, 4, 6, 8... Note 1)	$75 + 30 \frac{(n-4)}{2}$ (n = 4, 8, 12, 16... Note 2)	$80 + 30 \frac{(n-4)}{2}$ (n = 4, 8, 12, 16... Note 2)	$85 + 30 \frac{(n-4)}{2}$ (n = 4, 8, 12, 16... Note 2)
D-A5□/A6□ D-A59W D-F5□/J59 D-F5□W D-J59W D-F5BA D-F59F	With 2 pcs. (Different surfaces, Same surface), With 1 pc.	25	125	135	
	With n pcs. (Same surface)	$25 + 55 \frac{(n-2)}{2}$ (n = 2, 4, 6, 8... Note 1)	$125 + 55 \frac{(n-4)}{2}$ (n = 4, 8, 12, 16... Note 2)	$135 + 55 \frac{(n-4)}{2}$ (n = 4, 8, 12, 16... Note 2)	
D-F5NT	With 2 pcs. (Different surfaces, Same surface), With 1 pc.	35	145	155	
	With n pcs. (Same surface)	$35 + 55 \frac{(n-2)}{2}$ (n = 2, 4, 6, 8... Note 1)	$145 + 55 \frac{(n-4)}{2}$ (n = 4, 8, 12, 16... Note 2)	$155 + 55 \frac{(n-4)}{2}$ (n = 4, 8, 12, 16... Note 2)	
D-A3□ D-G39 D-K39	With 2 pcs.	Different surfaces	35	110	
		Same surface	100	110	
	With n pcs.	Different surfaces	$35 + 30(n-2)$ (n = 2, 3, 4, 5...)	$110 + 30(n-2)$ (n = 2, 4, 6, 8... Note 1)	
		Same surface	$100 + 100(n-2)$ (n = 2, 3, 4, 5...)	$110 + 100(n-2)$ (n = 2, 4, 6, 8... Note 1)	
With 1 pc.		15	110		
D-A44	With 2 pcs.	Different surfaces	35	110	
		Same surface	55	110	
	With n pcs.	Different surfaces	$35 + 30(n-2)$ (n = 2, 3, 4, 5...)	$110 + 30(n-2)$ (n = 2, 4, 6, 8... Note 1)	
		Same surface	$55 + 55(n-2)$ (n = 2, 3, 4, 5...)	$110 + 50(n-2)$ (n = 2, 4, 6, 8... Note 1)	
With 1 pc.		15	110		
D-Z7□ D-Z80 D-Y59□ D-Y7P D-Y7□W	With 2 pcs. (Different surfaces, Same surface), With 1 pc.	15	105	110	115
	With n pcs.	$15 + 40 \frac{(n-2)}{2}$ (n = 2, 4, 6, 8... Note 1)	$105 + 40 \frac{(n-4)}{2}$ (n = 4, 8, 12, 16... Note 2)	$110 + 40 \frac{(n-4)}{2}$ (n = 4, 8, 12, 16... Note 2)	$115 + 40 \frac{(n-4)}{2}$ (n = 4, 8, 12, 16... Note 2)
D-Y69□ D-Y7PV D-Y7□WV	With 2 pcs. (Different surfaces, Same surface), With 1 pc.	10	90	95	100
	With n pcs.	$10 + 30 \frac{(n-2)}{2}$ (n = 2, 4, 6, 8... Note 1)	$90 + 30 \frac{(n-4)}{2}$ (n = 4, 8, 12, 16... Note 2)	$95 + 30 \frac{(n-4)}{2}$ (n = 4, 8, 12, 16... Note 2)	$100 + 30 \frac{(n-4)}{2}$ (n = 4, 8, 12, 16... Note 2)
D-Y7BA	With 2 pcs. (Different surfaces, Same surface), With 1 pc.	20	115	120	125
	With n pcs.	$20 + 45 \frac{(n-2)}{2}$ (n = 2, 4, 6, 8... Note 1)	$115 + 45 \frac{(n-4)}{2}$ (n = 4, 8, 12, 16... Note 2)	$120 + 45 \frac{(n-4)}{2}$ (n = 4, 8, 12, 16... Note 2)	$125 + 45 \frac{(n-4)}{2}$ (n = 4, 8, 12, 16... Note 2)
P3DWA	With 2 pcs. (Different surfaces, Same surface), With 1 pc.	20	105	110	115
	With n pcs.	$20 + 50 \frac{(n-2)}{2}$ (n = 2, 4, 6, 8... Note 1)	$105 + 50 \frac{(n-4)}{2}$ (n = 4, 8, 12, 16... Note 2)	$110 + 50 \frac{(n-4)}{2}$ (n = 4, 8, 12, 16... Note 2)	$115 + 50 \frac{(n-4)}{2}$ (n = 4, 8, 12, 16... Note 2)

Note 1) When "n" is an odd number, an even number that is one larger than this odd number is used for the calculation. Note 2) When "n" is an odd number, a multiple of 4 that is larger than this odd number is used for the calculation.



### Operating Range

Auto switch model	Bore size (mm)		
	125	140	160
D-M9□/M9□V D-M9□W/M9□WV D-M9□A/M9□AV	6	6.5	6.5
D-A9□/A9□V	12	12.5	11.5
D-Z7□/Z80	14	14.5	13
D-A3□/A44 D-A5□/A6□	10	10	10
D-A59W	17	17	17
D-Y59□/Y69□ D-Y7P/Y7PV D-Y7□W/Y7□WV D-Y7BA	12	13	7
D-F5□/J59/F5□W D-J59W/F5BA D-F5NT/F59F	5	5	5.5
D-G39/K39	11	11	10
P3DWA	7	7	7

\* Since this is a guideline including hysteresis, not meant to be guaranteed.  
(Assuming approximately ±30% dispersion.)  
There may be the case it will vary substantially depending on an ambient environment.

### Auto Switch Mounting Bracket Part No.

Auto switch model	Bore size (mm)		
	ø125	ø140	ø160
D-M9□/M9□V D-M9□W/M9□WV D-M9□A/M9□AV D-A9□/A9□V	BS5-125	BS5-125	BS5-160
D-A5□/A6□ D-A59W D-F5□/J59 D-F5NT D-F5□W/J59W D-F5BAL/F59F	BT-12	BT-12	BT-16
D-A3□/A44 D-G39/K39	BS1-125	BS1-140	BS1-160
D-Z7□/Z80 D-Y59□/Y69□ D-Y7P/Y7PV D-Y7□W/Y7□WV D-Y7BA	BS4-125	BS4-125	BS4-160
P3DWA	BS7-125S	BS7-125S	BS7-160S

#### [Mounting screws set made of stainless steel]

The following set of mounting screws made of stainless steel (including set screws) is also available. Use it in accordance with the operating environment. (Please order the auto switch mounting bracket separately, since it is not included.)

BBA1: For D-A5, A6, F5, J5 type

\*D-F5BA" auto switch is set on the cylinder with the stainless steel screws above when shipped.

When only an auto switch is shipped independently, "BBA1" screws are attached.

Note) When using the D-M9□A/M9□AV or Y7BA model, do not use the steel set screw which is included with the auto switch mounting bracket in the above table (BS5-□□□, BS4-□□□). Please separately prepare the stainless steel screw set (BBA1), and select and use the M4 x 8L stainless steel set screw included in BBA1.

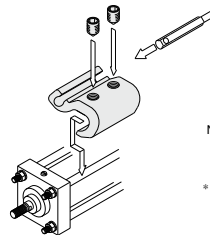

Note 1) Refer to page 1689 for the details of BBA1 screws.

\* Shows an example of mounting the D-A9□(V), M9□(V), M9□W(V), M9□A(V) model.

Other than the applicable auto switches listed in "How to Order", the following auto switches can be mounted. For detailed specifications, refer to pages 1575 to 1701.

Type	Model	Electrical entry (Direction)	Features
Reed auto switch	D-A90V	Grommet (Perpendicular)	Without indicator light
	D-A93V, A96V		
	D-Z73, Z76	Grommet (in-line)	Without indicator light
	D-A53, A56		
	D-A67		
Solid state auto switch	D-Z80	Grommet (in-line)	2-color indicator
	D-F59, F5P, J59		
	D-Y59A, Y59B, Y7P		
	D-F59W, F5PW, J59W		
	D-Y7NW, Y7PW, Y7BW		
	D-F5BA, Y7BA	Grommet (Perpendicular)	Water resistant (2-color indicator)
	D-F5NT		
	D-M9NV, M9PV, M9BV	Grommet (Perpendicular)	Water resistant (2-color indicator)
	D-Y69A, Y69B, Y7PV		
	D-M9NWV, M9PWV, M9BWW		
	D-Y7NWV, Y7PWV, Y7BWW		
D-M9NAV, M9PAV, M9BAV			

\* With pre-wired connector is available for solid state auto switches. For details, refer to pages 1648 and 1649.

\* Normally closed (NC = b contact), solid state switches (D-F9G, F9H, Y7G, Y7H type) are also available. For details, refer to pages 1593 and 1595.

CJ1

CJP

CJ2

JCM

CM2

CM3

CG1

CG3

JMB

MB

MB1

CA2

CS1

CS2

D-□

-X□

Technical Data