

High Power Cylinder

RHC Series

ø20, ø25, ø32, ø40, ø50, ø63, ø80, ø100

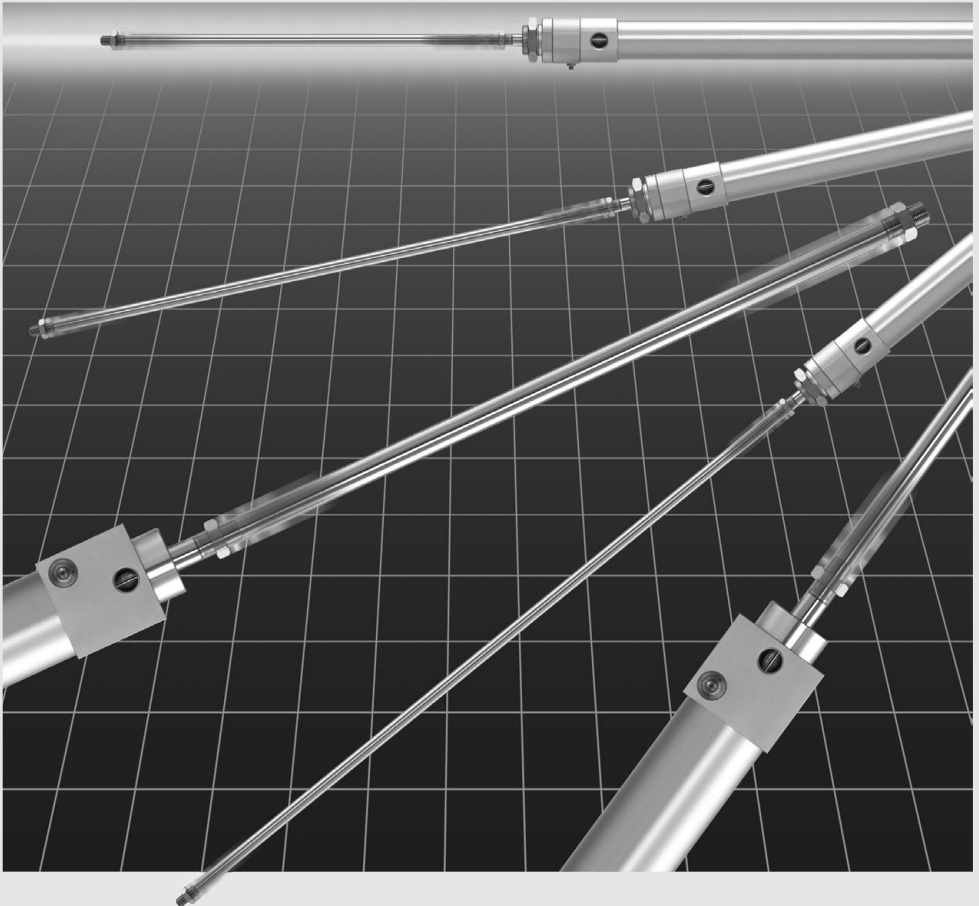

REA

REB

REC

Smooth

Low
Speed

MQ

RHC

RZQ

D-□

-X□

High power cylinder:

Smooth cushioning for high speed operation (3000 low/medium speed operation with heavy loads

The capacity to absorb 10 to 20 times more energy than general purpose cylinders.

Supply/Exhaust port

The diameter of the port orifice has been enlarged to support high speed operation.

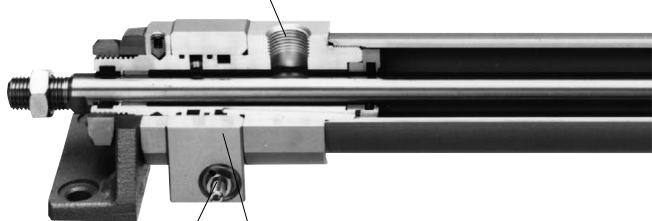
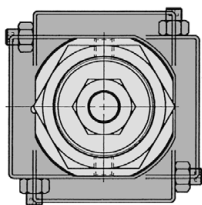

Relief valve adjusting screw

Relief valve body

The relief valve body rotates 360°, enabling relief adjustment from any direction. (ø20, ø25, ø32, ø40)

Mounting and Cushion Adjustment

Piping/mounting man-hours are the same as that of the general purpose cylinders.

Cushion adjustment (relief adjustment) man-hours are the same as the adjustment (cushion needle adjustment) for general purpose cylinders.

Quality of Cushioning (RHCF40-500, Load mass 5 kg, Supply pressure 0.5 MPa, Horizontal operation)

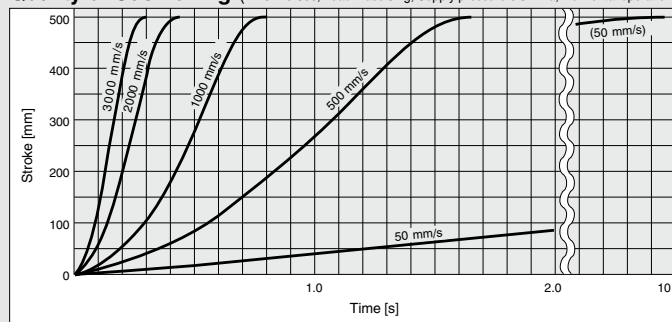

Cushion Capacity

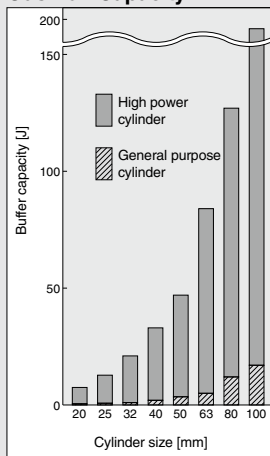

RHC Series

mm/s) with light loads and



Cushion ring

The long cushion ring can absorb larger energy (in terms of speed and weight).

Cushion seal

Strong seals are used for improved high speed durability and cushioning performance.



Relief valve

The relief valve is used as a cushion valve and it provides better cushioning performance than a needle throttle of a general purpose cylinder.

Application Examples

Opening/closing doors
(2000 mm/s,
several tens kg)

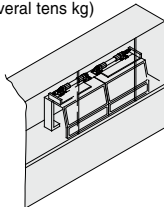

High speed Z-axis
(Up to 3000 mm/s, several kg)

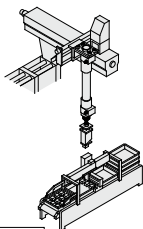

Transfer equipment
40 kg, 1000 mm/s (For $\phi 32$)

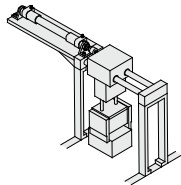

Working Principle

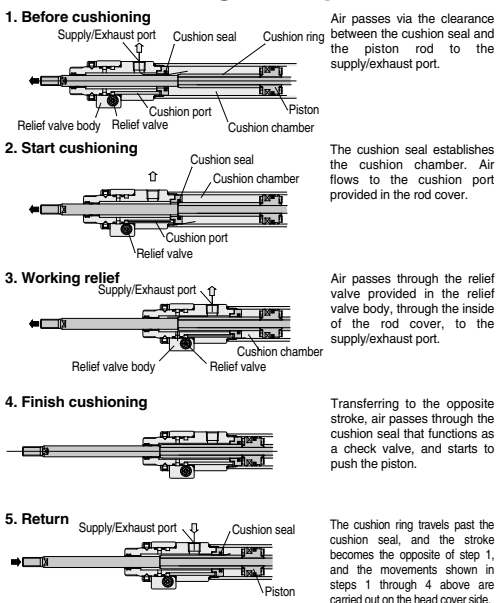

REA

REB

REC

Smooth

Low Speed

MQ

RHC

RZQ

D-□

-X□

RHC Series Model Selection

Model Selection Example of High Power Cylinder

Selection Example 1. Horizontal Drive

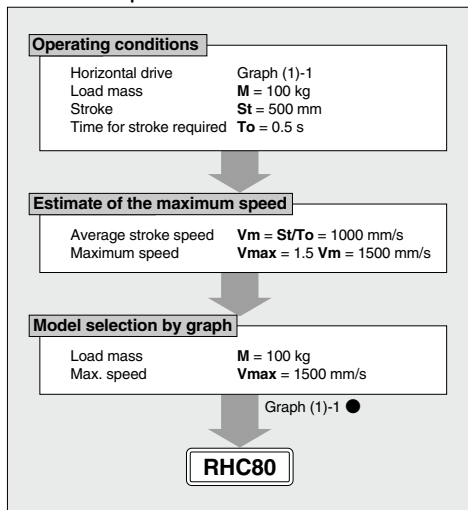

* Use an external guide, etc. for horizontal actuation of a load.

Graph (1)-1 Horizontal Drive Supply Pressure 0.5 MPa

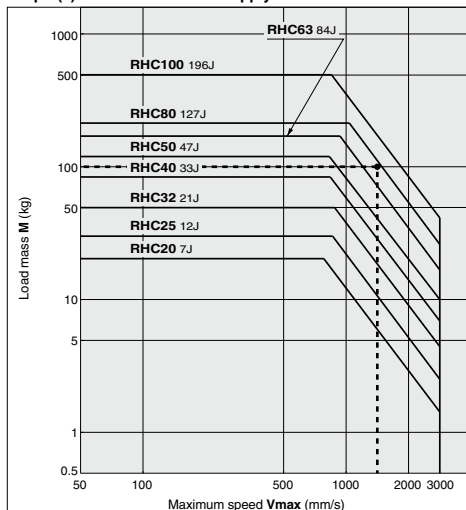

Selection Example 2. Vertical Drive

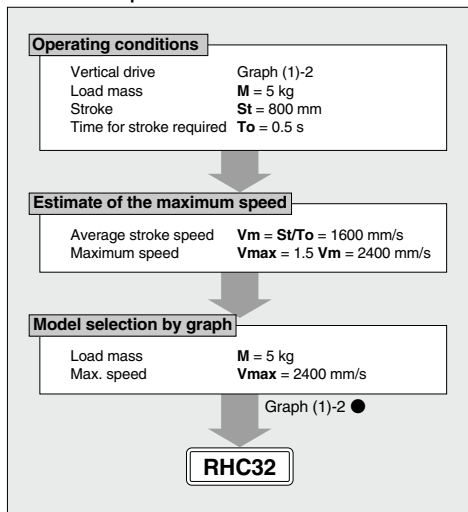

Graph (1)-2 Vertical Drive Supply Pressure 0.5 MPa

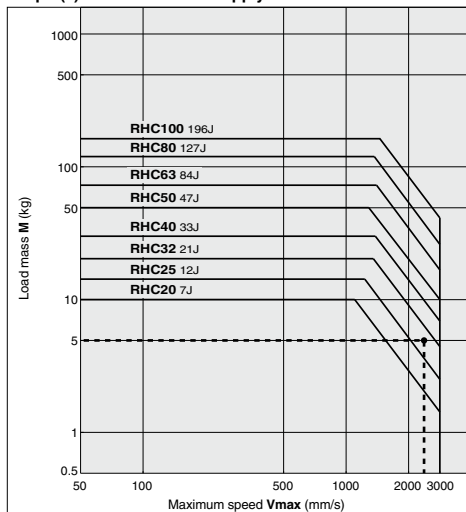

Maximum Energy Absorption

Bore size (mm)	20	25	32	40	50	63	80	100
Maximum energy absorption (J)	7	12	21	33	47	84	127	196

RHC Series System Selection

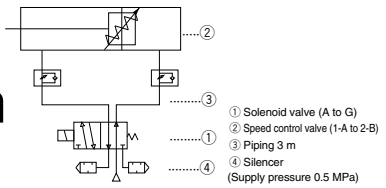

Apply η (cylinder load ratio) and V_{max} (max. speed) and determine effective sectional area "So".
Refer to "System Selection" table, and the appropriate solenoid valve, speed control valve and bore size may be selected.

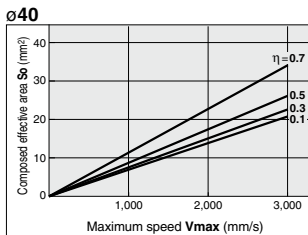
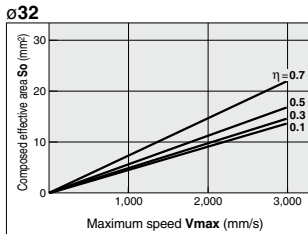
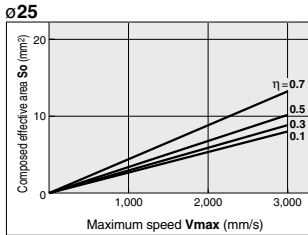
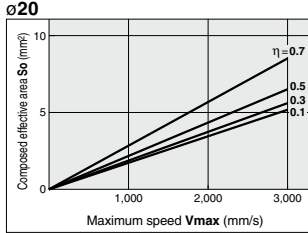

η : Cylinder load ratio

V_{max} : Maximum speed (Refer to page 348.)

System Selection

Bore size (mm)	Maximum speed (mm/s)	Solenoid valve (), Effective area [mm ²]					Speed controller		Tubing O.D. (mm) Steel piping size
		A	B	C	D	E	1- Standard type	2- With One-touch fittings	
		3.6 to 6.3	9.0 to 14.4	16.2 to 21.6	36 to 45	64.8 to 67		1-A Elbow type	
		VQ1000 (3.6)	VQ2000 (14.4)	—	VQ4000 (36.0)	—		1-B Universal type	
		VQ1000 (5.4)	—	VQ2000 (16.2)	—	—		1-C In-line type	
		SY3000 (5.4)	SY5000 (12.6)	SY7000 (21.6)	—	—		2-A Metal elbow type	
		SX3000 (5.4)	SX5000 (12.6)	SX7000 (21.6)	—	—		2-B In-line type	
		SYJ5000 (4.5)	SYJ7000 (12.6)	—	—	—			
		VQZ1000 (3.6)	VQZ2000 (12.6)	VQZ3000 (16.2)	—	—			
		—	VFS1000 (9.0)	VFS2000 (18.0)	VFS3000 (36.0)	VFS4000 (64.5)			
		—	—	VFR2000 (16.2)	VFR3000 (41.4)	VFR4000 (67.0)			
20	500						1-A AS22□1F (3.5)	1-A AS22□1F (3.5)	ø6
	1000						1-B AS2051F (4.5)	1-B AS2051F (4.5)	1/8, 1/4
	1500						1-C AS22□1 (2.9)	1-C AS22□1 (2.9)	
	2000						2-A AS2000 (3.8)	2-A AS2000 (3.8)	
	2500						1-C AS3001F (6.5)	1-C AS3001F (6.5)	ø6
	3000						2-B AS3000, AS3500 (12.3)	2-B AS3000, AS3500 (12.3)	1/4, 3/8
25	500						1-C AS4001F (16)	1-C AS4001F (16)	ø10
	1000						2-B AS3000, AS3500 (12.3)	2-B AS3000, AS3500 (12.3)	1/4, 3/8
	1500						1-C AS4001F (16)	1-C AS4001F (16)	ø10
	2000						2-B AS3000, AS3500 (12.3)	2-B AS3000, AS3500 (12.3)	1/4, 3/8
	2500						1-C AS4001F (16)	1-C AS4001F (16)	ø10
	3000						2-B AS3000, AS3500 (12.3)	2-B AS3000, AS3500 (12.3)	1/4, 3/8
32	500						1-C AS2051F (4.5)	1-C AS2051F (4.5)	ø6
	1000						2-B AS3000, AS3500 (12.3)	2-B AS3000, AS3500 (12.3)	1/4, 3/8
	1500						1-C AS3001F (10)	1-C AS3001F (10)	ø8
	2000						2-B AS3000, AS3500 (12.3)	2-B AS3000, AS3500 (12.3)	1/4, 3/8
	2500						1-C AS4001F (16)	1-C AS4001F (16)	ø10
	3000						2-B AS4000 (25.5)	2-B AS4000 (25.5)	1/4, 3/8
40	500						1-A AS32□1F (10)	1-A AS32□1F (10)	ø6
	1000						1-B AS33□1F (10)	1-B AS33□1F (10)	ø10
	1500						1-C AS4001F (16)	1-C AS4001F (16)	1/4, 3/8
	2000						2-A AS32□1 (13)	2-A AS32□1 (13)	
	2500						2-B AS3000, AS3500 (12.3)	2-B AS3000, AS3500 (12.3)	
	3000						1-C AS4001F (16)	1-C AS4001F (16)	ø10
40	500						2-A AS32□1 (13)	2-A AS32□1 (13)	1/4, 3/8
	1000						2-B AS3000, AS3500 (12.3)	2-B AS3000, AS3500 (12.3)	
	1500						1-C AS4001F (16)	1-C AS4001F (16)	ø10
	2000						2-B AS4000 (25.5)	2-B AS4000 (25.5)	1/4, 3/8
	2500						2-B AS5000 (74)	2-B AS5000 (74)	3/8
	3000						2-B AS5000 (74)	2-B AS5000 (74)	3/8
40	500						1-A AS32□1F (10)	1-A AS32□1F (10)	ø8
	1000						1-B AS33□1F (10)	1-B AS33□1F (10)	ø10
	1500						1-C AS4001F (16)	1-C AS4001F (16)	1/4, 3/8
	2000						2-A AS32□1 (13)	2-A AS32□1 (13)	
	2500						2-B AS3000, AS3500 (12.3)	2-B AS3000, AS3500 (12.3)	
	3000						1-C AS4001F (16)	1-C AS4001F (16)	3/8, ø12
40	500						2-B AS4000 (25.5)	2-B AS4000 (25.5)	3/8, ø12
	1000						2-B AS5000 (74)	2-B AS5000 (74)	3/8, ø12
	1500						2-B AS5000 (74)	2-B AS5000 (74)	3/8, ø12
	2000						2-B AS5000 (74)	2-B AS5000 (74)	3/8, ø12
	2500						2-B AS5000 (74)	2-B AS5000 (74)	3/8, ø12
	3000						2-B AS420 (74)	2-B AS420 (74)	3/8, ø12

Note) Refer to page 352 for maximum absorbed energy since cushioning ability may in some cases exceed the allowable cushioning ability if the cylinder is used under high speeds and large loads.

REA

REB

REC

Smooth

Low Speed

MQ

RHC

RZQ

D-□

-X□

Apply η (cylinder load ratio) and V_{max} (max. speed) and determine effective sectional area "So".

Refer to "System Selection" table, and the appropriate solenoid valve, speed control valve and bore size may be selected.

ø50

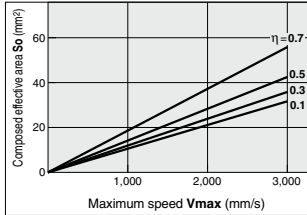

ø63

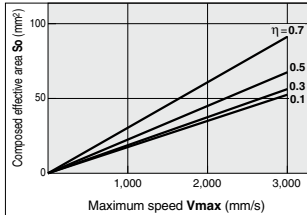

ø80

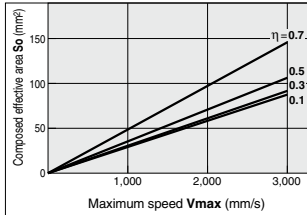

ø100

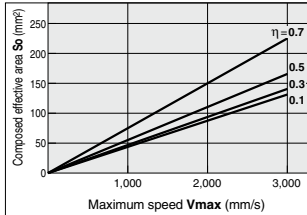

η : Cylinder load ratio

V_{max} : Maximum speed (Refer to page 348.)

System Selection

Bore size (mm)	Maximum speed (mm/s)	Composed effective area (mm ²)	Solenoid valve (): Effective area [mm ²]					Speed controller	Tubing I.D. (mm) Steel piping size		
			C 16.2 to 21.6	D 36 to 45	E 64.8 to 67	F 102.6 to 120	G 180 to 300				
50	9.5	VQ2000 (16.2)	—	—	—	—	—	1-A Elbow type 1-B Universal type 1-C In-line type 2-A Metal elbow type 2-B In-line type	ø8, ø10 1/4		
		SY7000 (21.6)	—	—	—	—	—				
		SX7000 (21.6)	—	—	—	—	—				
		VQ23000 (16.2)	—	—	—	—	—				
		VQ23000 (21.6)	—	—	—	—	—				
	1000	19	VFR2000 (16.2)	—	—	—	—	—		1-A AS42□1F (24)	
		—	VFR3000 (41.4)	—	—	—	—	—		2-B AS43□1F (24)	
		—	VFR4000 (67.0)	—	—	—	—	—		1-C AS4001F (16)	
		—	VFS3000 (36.0)	—	—	—	—	—		2-A AS4200 (26)	
		—	VFS4000 (64.5)	—	—	—	—	—		2-B AS420 (102)	
63	15	VQ2000 (16.2)	—	—	—	—	—	1-A AS42□1F (26) 2-B AS43□1F (24) 2-A AS4200 (26) 2-B AS420 (102) 2-B AS420 (102)	ø12, ø16 1/4, 3/8		
		VFR2000 (16.2)	—	—	—	—	—				
		VFR3000 (41.4)	—	—	—	—	—				
		VFR4000 (67.0)	—	—	—	—	—				
		VFS2000 (18.0)	—	—	—	—	—				
	500	15	VFS3000 (36.0)	—	—	—	—	—		1-A AS42□1F (24)	
		—	VFS4000 (64.5)	—	—	—	—	—		2-B AS43□1F (24)	
		—	VPC150 (120)	—	—	—	—	—		1-C AS4001F (16)	
		—	VPC170 (300)	—	—	—	—	—		2-A AS4200 (26)	
		—	—	—	—	—	—	—		2-B AS420 (102)	
80	1000	30	—	—	—	—	—	1-A AS42□1F (24)	ø10, ø12, ø16 1/4, 3/8		
		45	—	—	—	—	—	2-B AS43□1F (24)			
		60	—	—	—	—	—	1-C AS4001F (16)			
		75	—	—	—	—	—	2-A AS4200 (26)			
		89.5	—	—	—	—	—	2-B AS420 (102)			
	500	24.5	—	—	—	—	—	—		2-B AS420 (102)	
		48.5	—	—	—	—	—	—		2-A AS4200 (26)	
		72.5	—	—	—	—	—	—		2-B AS420 (102)	
		96.5	—	—	—	—	—	—		2-B AS500 (123)	
		120.5	—	—	—	—	—	—		2-B AS600 (258)	
100	1000	106	—	—	—	—	—	—	ø16 3/8, 1/2		
		38	—	—	—	—	—	—		2-B AS420 (102)	
		75.5	—	—	—	—	—	—		2-B AS500 (123)	
		113	—	—	—	—	—	—		2-B AS600 (258)	
		110.5	—	—	—	—	—	—		2-B AS600 (258)	
	500	38	—	—	—	—	—	—		—	2-B AS600 (258)
		75.5	—	—	—	—	—	—		—	2-B AS420 (102)
		113	—	—	—	—	—	—		—	2-B AS600 (258)
		110.5	—	—	—	—	—	—		—	2-B AS600 (258)
		138	—	—	—	—	—	—		—	2-B AS800 (586)
3000	88.5	—	—	—	—	—	—	—	2-B AS500 (123)		

Note) Refer to page 352 for the maximum absorbed energy since cushioning ability may in some cases exceed the allowable cushioning ability if the cylinder is used under high speeds and large loads.

High Power Cylinder

RHC Series

ø20, ø25, ø32, ø40, ø50, ø63, ø80, ø100

How to Order

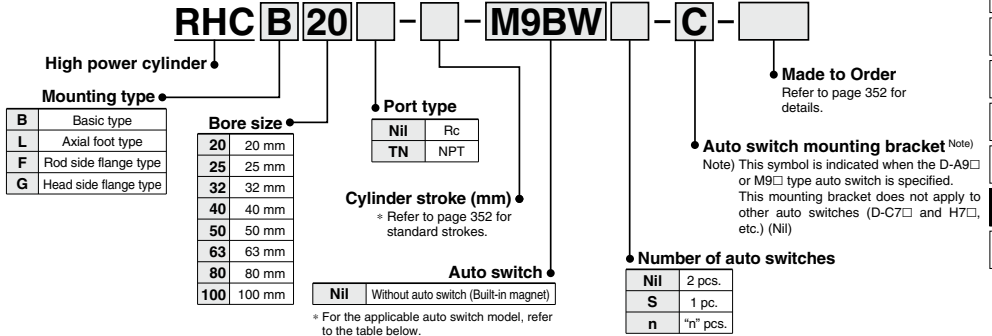

- REA
- REB
- REC
- Smooth
- Low Speed
- MQ
- RHC
- RZQ

Applicable Auto Switches

Refer to pages 941 to 1067 for further information on auto switches.

Type	Special function	Electrical entry	Indicator light	Wiring (Output)	Load voltage		Auto switch model					Lead wire length (m)				Pre-wired connector	Applicable load							
					DC	AC	Applicable bore size (mm)		0.5 (Nil)	1 (M)	3 (L)	5 (Z)	None (N)											
							ø20 to ø63	ø80, ø100																
Solid state auto switch	—	Grommet	No	3-wire (NPN)	5 V, 12 V	—	Perpendicular	M9NV	M9N	●	●	●	○	—	○	IC circuit								
				3-wire (PNP)				—	—	G59	●	●	●	○	—		○							
				2-wire				—	—	G5P	●	●	●	○	—		○							
		Connector	No	3-wire (NPN)				5 V, 12 V	—	In-line	M9BV	M9B	●	●	●		○	—	○	—				
				3-wire (PNP)							—	—	K59	●	●		●	○	—		○			
				2-wire							—	—	H7C	●	●		●	○	—		○			
		Terminal conduit	Yes	3-wire (NPN)				5 V, 12 V	—	In-line	—	G39	—	—	—		—	●	—	—	IC circuit			
				3-wire (PNP)							—	—	K39	—	—		—	●	—	—				
				2-wire							—	—	—	—	—		—	●	—	—				
	Diagnostic indication (2-color indicator)	Grommet	Yes	3-wire (NPN)	24 V	—	Perpendicular	M9NWX	M9NX	●	●	●	○	—	○	IC circuit								
				3-wire (PNP)				—	—	G59W	●	●	●	○	—		○							
				2-wire				—	—	G5PW	●	●	●	○	—		○							
				Water resistant (2-color indicator)				Grommet	Yes	3-wire (NPN)	5 V, 12 V	—	In-line	M9BWX	M9BW		●	●	●	○	—	○	—	
										3-wire (PNP)				—	—		K59W	●	●	●	○	—		○
										2-wire				—	—		—	—	—	—	●	—		—
With diagnostic output (2-color indicator)	Grommet	Yes	3-wire (NPN)	5 V, 12 V	—	Perpendicular	M9NAV ^{*1}	M9NA ^{*1}	—	○	○	●	○	—	IC circuit									
			3-wire (PNP)				—	—	○	○	○	●	○	—		○								
			2-wire				—	—	○	○	○	●	○	—		○								
Reed auto switch	—	Grommet	Yes	3-wire (NPN equivalent)	24 V	12 V	Perpendicular	A96V	A96	—	●	●	—	—	—	IC circuit								
				100 V				A93V ^{*2}	A93	—	●	●	●	—	—		—							
				100 V or less				A90V	A90	—	●	●	—	—	—		—	IC circuit						
		100 V, 200 V	—	B54				—	●	●	●	—	—	—										
		200 V or less	—	B64				—	●	●	—	—	—	—										
		Connector	No	No				2-wire	24 V	—	In-line	C73C	—	—	●		●	●	—	—	—			
												24 V or less	—	—	●		●	—	—	—		—		
												—	—	C80C	—		—	●	●	—		—	—	
		Terminal conduit	Yes	Yes				2-wire	24 V	—	In-line	—	A33	—	—		—	●	—	—	IC circuit			
	—				A34	—	—					—	●	—	—	—								
	—				A44	—	—					—	●	—	—	—								
	DIN terminal	Yes	Yes	2-wire	24 V	—	In-line	—	A44	—	—	—	●	—	—	—								
								—	A44	—	—	—	●	—	—		—							
								—	B59W	—	—	—	●	—	—		—							

*1 Water resistant type auto switches can be mounted on the above models, but in such case SMC cannot guarantee water resistance. Consult with SMC regarding water resistant types with the above model numbers.

*2 1 m type lead wire is only applicable to D-A93.

* Lead wire length symbols: 0.5 m.....Nil (Example) M9NW
1 m.....M (Example) M9NWM
3 m.....L (Example) M9NWL
5 m.....Z (Example) M9NWZ
None.....N (Example) H7CN

* Solid state auto switches marked with "○" are produced upon receipt of order.
* D-A9□/M9□/M9□/WW/D-M9□(V) types cannot be mounted.
* Do not indicate suffix "N" for no lead wire on D-A3□/A44/G39/K39 models.

* Since there are other applicable auto switches than listed, refer to page 364 for details.
* For details about auto switches with pre-wired connector, refer to pages 1014 and 1015.
* D-A9□/M9□/M9□/WW auto switches are shipped together (not assembled). (Only auto switch mounting brackets are assembled before shipped.)

- D-□
- X-□

RHC Series



Symbol

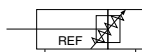

Made to Order
[Click here for details](#)

Symbol	Specification
-XC3	Special port location*
-XC6	Made of stainless steel
-XC93	Water resistance + Stable lubrication function**

* ø20 to ø40 only

** ø32, ø40 only

Specifications

Bore size (mm)	20	25	32	40	50	63	80	100
Fluid	Air							
Proof pressure	1.5 MPa							
Maximum operating pressure	1.0 MPa							
Minimum operating pressure	0.05 MPa							
Ambient and fluid temperature	-10 to 60°C (No freezing)							
Piston speed	50 to 3000 mm/s							
Cushion	Air cushion							
Maximum energy absorption (J)	7	12	21	33	47	84	127	196
Effective cushioning stroke (mm)	80	80	80	80	80	80	80	80
Lubrication	Not required (Non-lube)							
Stroke length tolerance	Up to 1000 st: $^{+1.4}_0$, 1001 to 1500 st: $^{+1.8}_0$							
Mounting	Basic type, Axial foot type, Rod/Head side flange type							

Stroke

Bore size (mm)	Minimum stroke (Recommended) ⁽¹⁾	Standard stroke ⁽²⁾	Max. stroke
20	250	up to 700	1500
25	250	up to 700	1500
32	250	up to 1000	1500
40	250	up to 1000	1500
50	250	up to 1200	1500
63	250	up to 1200	1500
80	250	up to 1400	1500
100	250	up to 1500	1500

Note 1) Strokes shorter than the recommended minimum stroke (1 to 249 st) can be manufactured, but cushion capability may not be satisfied since the effective cushion stroke for this cylinder is long.
 Note 2) Stroke exceeding the standard stroke length is not subject to the guarantee.

Mounting Bracket Part No.

Mounting bracket	Qty.	Bore size (mm)								Description
		20	25	32	40	50	63	80	100	
Axial foot	Note) 2	RHC-L020	RHC-L025	RHC-L032	RHC-L040	RHC-L050	RHC-L063	RHC-L080	RHC-L100	ø20 to ø40 : Foot x 2, Mounting nut x 1 ø50 to ø100: Foot x 2, Bracket mounting bolt x 8, Spring washer x 8
Flange	1	RHC-F020	RHC-F025	RHC-F032	RHC-F040	RHC-F050	RHC-F063	RHC-F080	RHC-F100	ø20 to ø40 : Flange x 1 ø50 to ø100: Flange x 1, Bracket mounting bolt x 4, Spring washer x 4

Note) Order 2 foot brackets for a cylinder.

Theoretical Output



Bore size (mm)	Rod size (mm)	Operating direction	Piston area (mm ²)	Operating pressure (MPa)								
				0.2	0.3	0.4	0.5	0.6	0.7	0.8	0.9	1.0
20	10	OUT	314	63	94	126	157	188	220	251	283	314
		IN	236	47	71	94	118	142	165	189	212	236
25	12	OUT	491	98	147	196	246	295	344	393	442	491
		IN	378	76	113	151	189	227	265	302	340	378
32	12	OUT	804	161	241	322	402	482	563	643	724	804
		IN	691	138	207	276	346	415	484	553	622	691
40	16	OUT	1260	252	378	504	630	756	882	1010	1130	1260
		IN	1060	212	318	424	530	636	742	848	954	1060
50	20	OUT	1960	392	588	784	980	1180	1370	1570	1760	1960
		IN	1650	330	495	660	825	990	1160	1320	1490	1650
63	20	OUT	3120	624	936	1250	1560	1870	2180	2500	2810	3120
		IN	2800	560	840	1120	1400	1680	1960	2240	2520	2800
80	25	OUT	5030	1010	1510	2010	2520	3020	3520	4020	4530	5030
		IN	4540	908	1360	1820	2270	2720	3180	3630	4090	4540
100	30	OUT	7850	1570	2360	3140	3930	4710	5500	6280	7070	7850
		IN	7150	1430	2150	2860	3580	4290	5010	5720	6440	7150

(Note) Theoretical output (N) = Pressure (MPa) x Piston area (mm²)

Weight (In the case of 500 stroke)

Bore size (mm)		20	25	32	40	50	63	80	100
Basic weight	Basic type	1.20	1.62	2.04	3.20	4.90	6.08	8.93	13.60
	Axial foot type	1.44	1.88	2.44	3.72	5.95	7.32	11.04	16.67
	Flange type	1.29	1.79	2.23	3.47	5.68	6.97	10.67	15.92
Additional weight per each 50 mm of stroke		0.06	0.08	0.09	0.15	0.22	0.25	0.35	0.51

Calculation: (Example) **RHCL32-600**

- Basic mass (500 st) 2.44 (kg) (Foot type ø32)
 - Additional weight 0.09 (kg/50 st)
 - Cylinder stroke 600 (st)
- 2.44 + 0.09 x (600 - 500)/50 = 2.62 kg

Series Applicable to Operating Environments that Do Not Accept Copper

- Copper and Fluorine-free.....20-series
- * For details, refer to the SMC website.

REA

REB

REC

Smooth

Low Speed

MQ

RHC

RZQ

D-□

-X□

RHC Series

Construction: $\varnothing 20$ to $\varnothing 40$

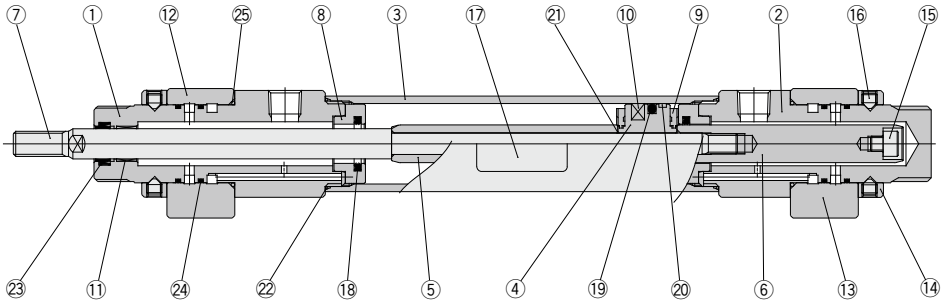

Component Parts

No.	Description	Material	Qty.	Note
1	Rod cover	Aluminum alloy	1	Clear anodized
2	Head cover	Aluminum alloy	1	Clear anodized
3	Cylinder tube	Aluminum alloy	1	Hard anodized
4	Piston	Aluminum alloy	1	Chromated
5	Cushion ring A	Carbon steel	1	Hard chrome plated
6	Cushion ring B	Carbon steel	1	Hard chrome plated
7	Piston rod	Carbon steel*	1	Hard chrome plated
8	Cushion spacer	Steel	2	Chromated
9	Bumper	Urethane	2	
10	Magnet	—	1	
11	Bushing	Bearing alloy	1	
12	Relief valve assembly (Rod side)	—	1	
13	Relief valve assembly (Head side)	—	1	
14	Relief valve body holder	Aluminum alloy	2	Clear anodized
15	Hexagon socket head cap screw	Carbon steel	1	$\varnothing 20$: M5 x 0.8 x 6 $\varnothing 25$, $\varnothing 32$: M6 x 1 x 6 $\varnothing 40$: M8 x 1.25 x 8
16	Hexagon socket head set screw	Carbon steel	2	$\varnothing 20$, $\varnothing 25$: M5 x 0.8 x 6 $\varnothing 32$, $\varnothing 40$: M6 x 1 x 8
17	Plate	—	1	
18	Cushion seal	Special resin	2	
19	Piston seal	NBR	1	
20	Wear ring	Resin	1	
21	Piston gasket	NBR	1	
22	Cylinder tube gasket	NBR	2	
23	Rod seal	NBR	1	
24	O-ring	NBR	4	
25	O-ring	NBR	2	

* Stainless steel for $\varnothing 20$ and $\varnothing 25$

Replacement Parts/Seal Kit

Bore size (mm)	Kit no.	Contents
20	RHC20-PS	Set of nos. left 18, 19, 20, 22, 23, 24, 25
25	RHC25-PS	
32	RHC32-PS	
40	RHC40-PS	

* Seal kit includes a grease pack (10 g).

Order with the following part number when only the grease pack is needed.

Grease pack part no.: GR-S-010 (10 g)

⚠ Caution

When disassembling cylinders with bore sizes of $\varnothing 20$ through $\varnothing 40$, grip the double flat part of either the rod cover or the head cover with a vise and loosen the other side with a wrench or an adjustable angle wrench, and then remove the cover. When re-tightening, tighten approximately 2 degrees more than the original position.

Construction: $\varnothing 50$ to $\varnothing 100$

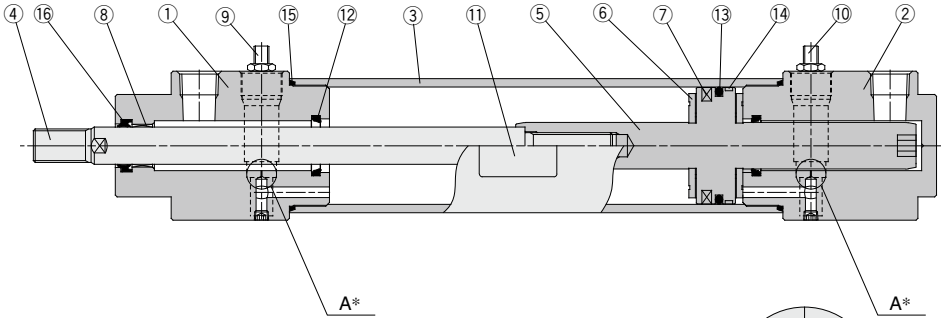

Enlarged view of "A"

Component Parts

No.	Description	Material	Note
1	Rod cover	Aluminum alloy	Clear anodized
2	Head cover	Aluminum alloy	Clear anodized
3	Cylinder tube	Aluminum alloy	Hard anodized
4	Piston rod	Carbon steel	Hard chromate plated
5	Piston	Aluminum alloy	Hard anodized
6	Bumper	Urethan	
7	Magnet	—	
8	Bushing	Bearing alloy	
9	Relief valve assembly L	—	
10	Relief valve assembly R	—	
11	Plate	—	
12	Cushion seal	Urethan	
13	Piston seal	NBR	
14	Wear ring	Resin	
15	Cylinder tube gasket	NBR	
16	Rod seal	NBR	

Caution

Cylinders with $\varnothing 50$ or larger bore sizes are tightened with a large tightening torque and cannot be disassembled. Contact SMC when disassembly is required.

- REA
- REB
- REC
- Smooth
- Low Speed
- MQ
- RHC**
- RZQ

- D-
- X

RHC Series

Dimensions: Basic Type

ø20 to ø40

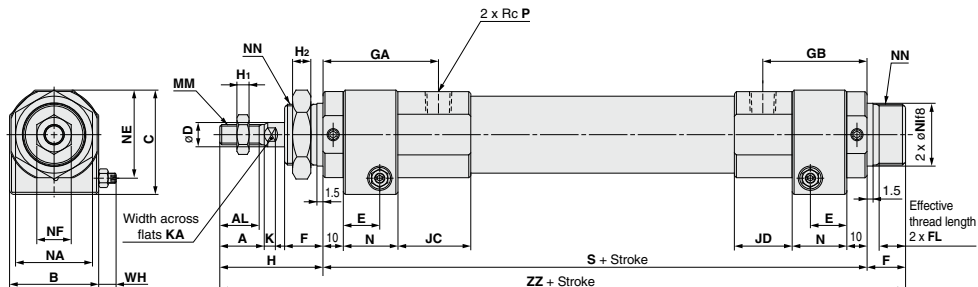

Bore size (mm)	A	AL	B	C	D	E	F	FL	GA	GB	H	H ₁	H ₂
20	18	15.5	32	40.5	10	14.5	16	11.5	53.5	47.5	44	5	8
25	22	19.5	36	45.5	12	18	16	11.5	56.5	49.5	48	6	8
32	22	19.5	44	51.5	12	18	19	14.5	55	51.5	51	6	9
40	24	21	53	61.5	16	20.5	21	16.5	56	51.5	54.5	8	11

Bore size (mm)	JC	JD	K	KA	MM	N	NE	NA	NF	NI	NN	P	S	WH	ZZ
20	43	30.5	5	8	M8 x 1.25	22	33.5	26	13	23 ^{+0.022} _{-0.023}	M22 x 1.5	1/4	192	5.8 to 8.8	252
25	39	25.5	5.5	10	M10 x 1.25	27	37	32	17	25 ^{+0.022} _{-0.023}	M24 x 1.5	1/4	193		257
32	36	28.5	5.5	10	M10 x 1.25	27	43.5	38	17	31 ^{+0.022} _{-0.024}	M30 x 1.5	3/8	195	6.8 to 11.3	265
40	32	23	7.5	14	M14 x 1.5	30	52.5	41	22	34 ^{+0.022} _{-0.024}	M33 x 2.0	3/8	201.5		277

ø50 to ø100

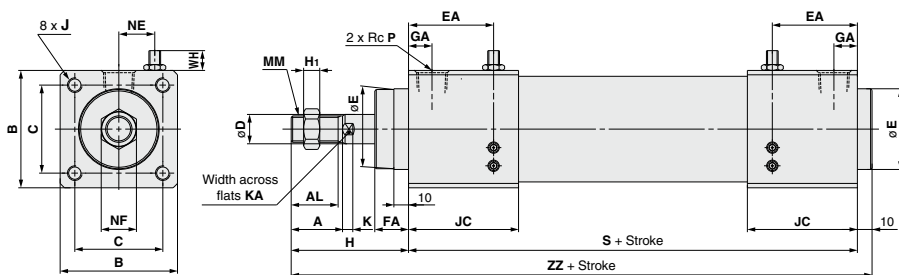

Bore size (mm)	A	AL	B	C	D	E	EA	FA	GA	H
50	35	32	70	53	20	50 ^{+0.022} _{-0.023}	62	23	16	80
63	35	32	80	60	20	55 ^{+0.022} _{-0.024}	58	23	16	80
80	40	37	95	75	25	65 ^{+0.022} _{-0.024}	61	23	20	90
100	40	37	116	90	30	80 ^{+0.022} _{-0.024}	63	25	20	95

Bore size (mm)	H ₁	J	JC	K	KA	MM	NE	NF	P	S	WH	ZZ
50	11	M10 x 1.5 thread depth 20	75	7	18	M18 x 1.5	25	27	1/2	215	6.8 to 11.3	305
63	11	M10 x 1.5 thread depth 20	75	7	18	M18 x 1.5	24.5	27	1/2	215		305
80	13	M12 x 1.75 thread depth 25	78	10	22	M22 x 1.5	30.5	32	3/4	228	8.5 to 13.5	328
100	16	M12 x 1.75 thread depth 25	80	10	26	M26 x 1.5	34	41	3/4	236		341

Dimensions: Axial Foot Type

ø20 to ø40

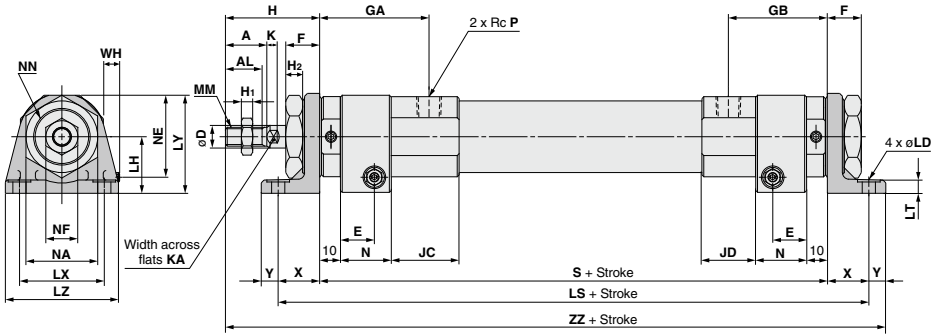

Bore size (mm)	A	AL	D	E	F	GA	GB	H	H ₁	H ₂	JC	JD	K	KA	LD	LH
20	18	15.5	10	14.5	16	53.5	47.5	44	5	8	43	30.5	5	8	7	25
25	22	19.5	12	18	16	56.5	49.5	48	6	8	39	25.5	5.5	10	7	28
32	22	19.5	12	18	19	55	51.5	51	6	9	36	28.5	5.5	10	7	30
40	24	21	16	20.5	21	56	51.5	54.5	8	11	32	23	7.5	14	9	35

Bore size (mm)	LS	LT	LX	LY	LZ	MM	N	NA	NE	NF	NN	P	S	WH	X	Y	ZZ
20	232	6.5	40	41	55	M8 x 1.25	22	26	33.5	13	M22 x 1.5	1/4	192	5.8 to 8.8	20	9	265
25	233	6.5	40	46.5	55	M10 x 1.25	27	32	37	17	M24 x 1.5	1/4	193		20	9	270
32	241	7	45	53	60	M10 x 1.25	27	38	43.5	17	M30 x 1.5	3/8	195	6.8 to 11.3	23	9	278
40	251.5	7	55	62	75	M14 x 1.5	30	41	52.5	22	M33 x 2.0	3/8	201.5		25	11	292

ø50 to ø100

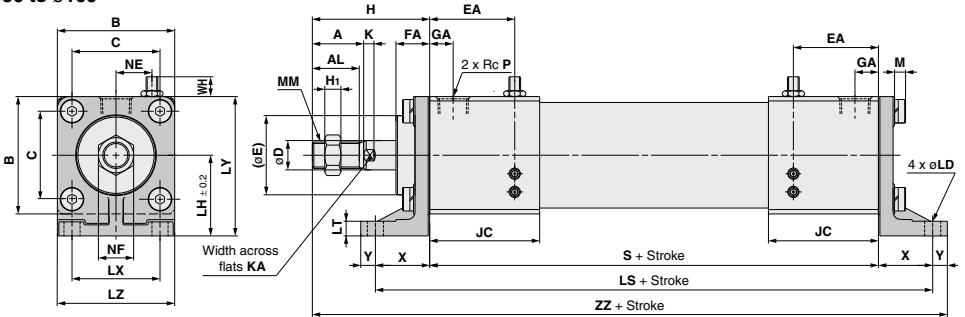

Bore size (mm)	A	AL	B	C	D	E	EA	FA	GA	H	H ₁	JC	K	KA	LD
50	35	32	70	53	20	50 ^{+0.030}	62	23	16	80	11	75	7	18	11
63	35	32	80	60	20	55 ⁰ _{-0.074}	58	23	16	80	11	75	7	18	11
80	40	37	95	75	25	65 ⁰ _{-0.074}	61	23	20	90	13	78	10	22	13
100	40	37	116	90	30	80 ^{+0.074}	63	25	20	95	16	80	10	26	13

Bore size (mm)	LH	LS	LT	LY	LX	LZ	M	MM	NE	NF	P	S	WH	X	Y	ZZ
50	52	275	10	88.5	53	73	7.5	M18 x 1.5	25	27	1/2	215	6.8 to 11.3	30	10	335
63	55	289	10	95	60	80	7.5	M18 x 1.5	24.5	27	1/2	215		37	10	342
80	65	308	12	115	75	100	10	M22 x 1.5	30.5	32	3/4	228	8.5 to 13.5	40	13	371
100	80	330	14	139	90	118	10	M26 x 1.5	34	41	3/4	236		47	13	391

- REA
- REB
- REC
- Smooth
- Low Speed
- MQ
- RHC**
- RZQ

- D-□
- X□

RHC Series

Dimensions: Rod Side Flange Type

ø20 to ø40

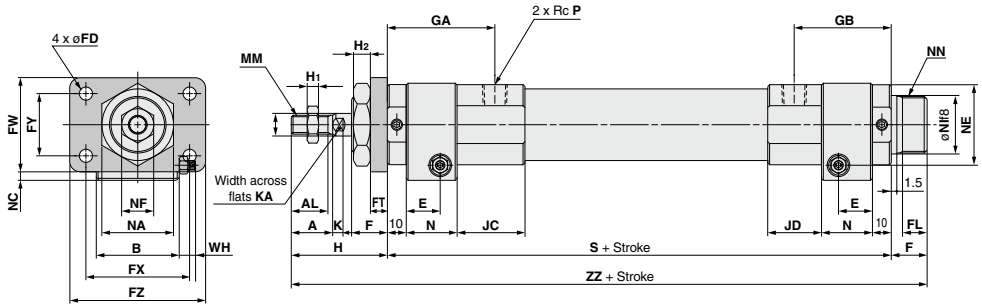

(mm)

Bore size (mm)	A	AL	B	D	E	F	FL	FD	FT	FX	FY	FW	FZ	GA	GB	H ₁	H ₂
20	18	15.5	32	10	14.5	16	11.5	7	6	51	21	38	68	53.5	47.5	5	8
25	22	19.5	36	12	18	16	11.5	7	9	53	27	44	70	56.5	49.5	6	8
32	22	19.5	44	12	18	19	14.5	7	9	55	33	50	72	55	51.5	6	9
40	24	21	53	16	20.5	21	16.5	9	9	66	36	60	84	56	51.5	8	11

Bore size (mm)	H	JC	JD	K	KA	MM	N	NA	NC	NE	NF	NI	NN	P	S	WH	ZZ
20	44	43	30.5	5	8	M8 x 1.25	22	26	5.5	33.5	13	23 ^{+0.020} _{-0.023}	M22 x 1.5	1/4	192		252
25	48	39	25.5	5.5	10	M10 x 1.25	27	32	5.5	37	17	25 ^{+0.020} _{-0.023}	M24 x 1.5	1/4	193	5.8 to 8.8	257
32	51	36	28.5	5.5	10	M10 x 1.25	27	38	4.5	43.5	17	31 ^{+0.020} _{-0.024}	M30 x 1.5	3/8	195		265
40	54.5	32	23	7.5	14	M14 x 1.5	30	41	4.5	52.5	22	34 ^{+0.025} _{-0.024}	M33 x 2.0	3/8	201.5	6.8 to 11.3	277

ø50 to ø100

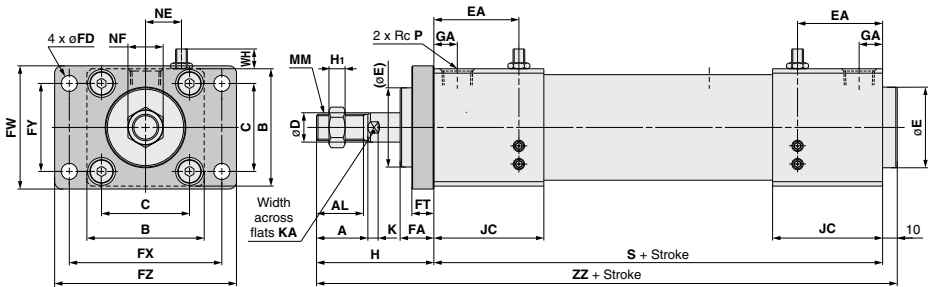

(mm)

Bore size (mm)	A	AL	B	C	D	E	EA	FA	FD	FT	FW	FX
50	35	32	70	53	20	50 ^{+0.020}	62	23	11	15	78	96
63	35	32	80	60	20	55 ^{+0.024}	58	23	11	15	84	104
80	40	37	95	75	25	65 ^{+0.024}	61	23	13	18	106	130
100	40	37	116	90	30	80 ^{+0.024}	63	25	13	20	120	145

Bore size (mm)	FY	FZ	GA	H	H ₁	JC	K	KA	MM	NE	NF	P	S	WH	ZZ
50	53	116	16	80	11	75	7	18	M18 x 1.5	25	27	1/2	215	6.8 to 11.3	305
63	60	124	16	80	11	75	7	18	M18 x 1.5	24.5	27	1/2	215		305
80	75	155	20	90	13	78	10	22	M22 x 1.5	30.5	32	3/4	228	8.5 to 13.5	328
100	90	172	20	95	16	80	10	26	M26 x 1.5	34	41	3/4	236		341

Dimensions: Head Side Flange Type

ø20 to ø40

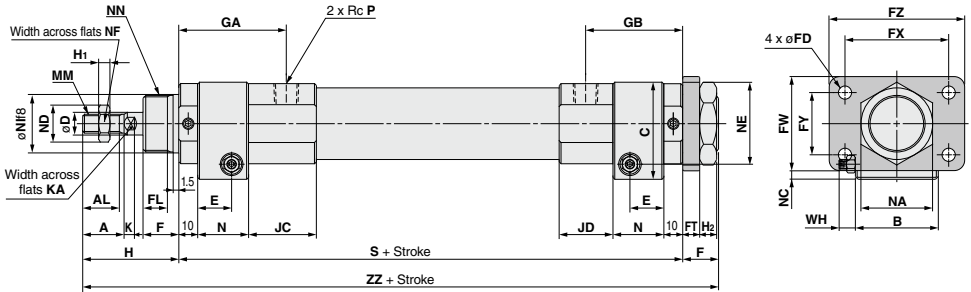

Bore size (mm)	A	AL	B	C	D	E	F	FL	FD	FT	FX	FY	FW	FZ	GA	GB	H ₁	H ₂
20	18	15.5	32	40.5	10	14.5	16	11.5	7	6	51	21	38	68	53.5	47.5	5	8
25	22	19.5	36	45.5	12	18	16	11.5	7	9	53	27	44	70	56.5	49.5	6	8
32	22	19.5	44	51.5	12	18	19	14.5	7	9	55	33	50	72	55	51.5	6	9
40	24	21	53	61.5	16	20.5	21	16.5	9	9	66	36	60	84	56	51.5	8	11

Bore size (mm)	H	JC	JD	K	KA	MM	N	NA	NB	NC	NE	NF	NI	NN	P	S	WH	ZZ
20	44	43	30.5	5	8	M8 x 1.25	22	26	30	5.5	33.5	13	23 ^{+0.020} _{-0.053}	M22 x 1.5	1/4	192	5.8 to 8.8	252
25	48	39	25.5	5.5	10	M10 x 1.25	27	32	36.9	5.5	37	17	25 ^{+0.020} _{-0.053}	M24 x 1.5	1/4	193	5.8 to 8.8	257
32	51	36	28.5	5.5	10	M10 x 1.25	27	38	43.9	4.5	43.5	17	31 ^{+0.020} _{-0.052}	M30 x 1.5	3/8	195	6.8 to 11.3	265
40	54.5	32	23	7.5	14	M14 x 1.5	30	41	47.3	4.5	52.5	22	34 ^{+0.025} _{-0.054}	M33 x 2.0	3/8	201.5	6.8 to 11.3	277

ø50 to ø100

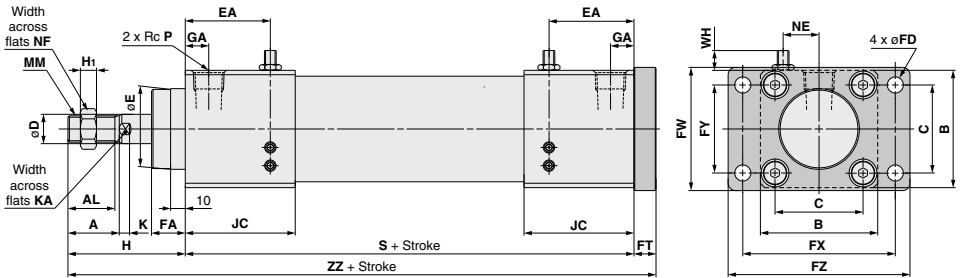

Bore size (mm)	A	AL	B	C	D	E	EA	FA	FD	FT	FW	FX	FY
50	35	32	70	53	20	50 ^{+0.062}	62	23	11	15	78	96	53
63	35	32	80	60	20	55 ^{+0.074}	58	23	11	15	84	104	60
80	40	37	95	75	25	65 ^{+0.074}	61	23	13	18	106	130	75
100	40	37	116	90	30	80 ^{+0.074}	63	25	13	20	120	145	90

Bore size (mm)	FZ	GA	H	H ₁	JC	K	KA	MM	NE	NF	P	S	WH	ZZ
50	116	16	80	11	75	7	18	M18 x 1.5	25	27	1/2	215	6.8 to 11.3	310
63	124	16	80	11	75	7	18	M18 x 1.5	24.5	27	1/2	215	6.8 to 11.3	310
80	155	20	90	13	78	10	22	M22 x 1.5	30.5	32	3/4	228	8.5 to 13.5	336
100	172	20	95	16	80	10	26	M26 x 1.5	34	41	3/4	236	8.5 to 13.5	351

- REA
- REB
- REC
- Smooth
- Low Speed
- MQ
- RHC**
- RZQ

- D
- X

RHC Series Accessory

Mounting Nut

(mm)

Material: Carbon steel

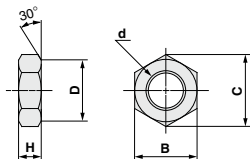

Part no.	Applicable bore size (mm)	B	C	D	d	H
SOR-20	20	26	30	26	M22 x 1.5	8
SOR-25	25	32	36.9	32	M24 x 1.5	8
SOR-32	32	38	43.9	38	M30 x 1.5	9
SOR-40	40	41	47.3	41	M33 x 2.0	11

Rod End Nut

(mm)

Material: Carbon steel

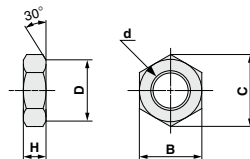

Part no.	Applicable bore size (mm)	B	C	D	d	H
NT-02	20	13	15	12.5	M8 x 1.25	5
NT-03	25/32	17	19.6	16.5	M10 x 1.25	6
NT-04	40	22	25.4	21.0	M14 x 1.5	8
NT-05	50/63	27	31	26	M18 x 1.5	11
NT-08	80	32	37	31	M22 x 1.5	13
NT-10	100	41	47.3	39	M26 x 1.5	16

Auto Switch Mounting 1

Minimum Stroke for Auto Switch Mounting

n: No. of auto switches (mm)

Auto switch model	No. of auto switches mounted				
	1	2		n	
		Different surfaces	Same surface	Different surfaces	Same surface
D-A9□ D-M9□ D-M9□W	10	15 Note 1)	45 Note 1)	$15 + 45 \frac{(n-2)}{2}$ (n = 2, 4, 6...) ^{Note 3)}	$45 + 45 (n-2)$ (n = 2, 3, 4, 5...)
D-M9□	5	15 Note 1)	40 Note 1)	$20 + 35 \frac{(n-2)}{2}$ (n = 2, 4, 6...) ^{Note 3)}	$55 + 35 (n-2)$ (n = 2, 3, 4, 5...)
D-M9□W	10	15 Note 1)	40 Note 1)	$20 + 35 \frac{(n-2)}{2}$ (n = 2, 4, 6...) ^{Note 3)}	$55 + 35 (n-2)$ (n = 2, 3, 4, 5...)
D-M9□A	10	25	40 Note 1)	$25 + 35 \frac{(n-2)}{2}$ (n = 2, 4, 6...) ^{Note 3)}	$60 + 35 (n-2)$ (n = 2, 3, 4, 5...)
D-A9□	5	15	30 Note 1)	$15 + 35 \frac{(n-2)}{2}$ (n = 2, 4, 6...) ^{Note 3)}	$50 + 35 (n-2)$ (n = 2, 3, 4, 5...)
D-M9□V	5	20	35	$20 + 35 \frac{(n-2)}{2}$ (n = 2, 4, 6...) ^{Note 3)}	$35 + 35 (n-2)$ (n = 2, 3, 4, 5...)
D-A9□V	5	15	25	$15 + 35 \frac{(n-2)}{2}$ (n = 2, 4, 6...) ^{Note 3)}	$25 + 35 (n-2)$ (n = 2, 3, 4, 5...)
D-M9□WV D-M9□AV	10	20	35	$20 + 35 \frac{(n-2)}{2}$ (n = 2, 4, 6...) ^{Note 3)}	$35 + 35 (n-2)$ (n = 2, 3, 4, 5...)
D-C7□ D-C80	10	15	50	$15 + 45 \frac{(n-2)}{2}$ (n = 2, 4, 6...) ^{Note 3)}	$50 + 45 (n-2)$ (n = 2, 3, 4, 5...)
D-H7□ D-H7□W D-H7BA D-H7NF	10	15	60	$15 + 45 \frac{(n-2)}{2}$ (n = 2, 4, 6...) ^{Note 3)}	$60 + 45 (n-2)$ (n = 2, 3, 4, 5...)
D-C73C D-C80C D-H7C	10	15	65	$15 + 50 \frac{(n-2)}{2}$ (n = 2, 4, 6...) ^{Note 3)}	$65 + 50 (n-2)$ (n = 2, 3, 4, 5...)
D-B5□/B64 D-G5□/K59 D-G5□W/K59W D-G5BA D-G5NT	10	15	75	$15 + 50 \frac{(n-2)}{2}$ (n = 2, 4, 6...) ^{Note 3)}	$75 + 55 (n-2)$ (n = 2, 3, 4, 5...)
D-B59W	15	20	75	$20 + 50 \frac{(n-2)}{2}$ (n = 2, 4, 6...) ^{Note 3)}	$75 + 55 (n-2)$ (n = 2, 3, 4, 5...)
D-A3□ D-A44 D-G39 D-K39	10	35	100	$35 + 30 (n-2)$ (n = 2, 3, 4, 5...)	$100 + 100 (n-2)$ (n = 2, 3, 4, 5...)

Note 3) When "n" is an odd number, an even number that is one larger than this odd number is used for the calculation.

Note 1) Auto switch mounting

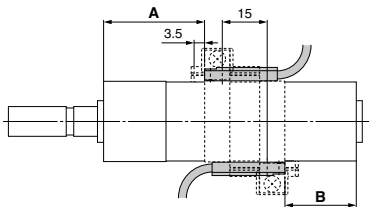
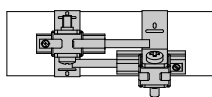
Auto switch model	2 auto switches	
	Different surfaces Note 1)	Same surface Note 1)
	 <p>Correct auto switch mounting position is 3.5 mm from the back face of the switch holder.</p>	 <p>The auto switch is mounted by slightly displacing it in a direction (cylinder tube circumferential exterior) so that the auto switch and lead wire do not interfere with each other.</p>
D-M9□ D-M9□W	Less than 20 stroke Note 2)	Less than 55 stroke Note 2)
D-M9□A	Less than 20 stroke Note 2)	Less than 60 stroke Note 2)
D-A9□	—	Less than 50 stroke Note 2)

Note 2) Minimum stroke for auto switch mounting in types other than those mentioned in Note 1.

- REA
- REB
- REC
- Smooth
- Low Speed
- MQ
- RHC
- RZQ

- D-□
- X□

Auto Switch Mounting 2

Auto Switch Proper Mounting Position (Detection at Stroke End) and Its Mounting Height

Reed auto switch

D-A9□

ø20 to ø40

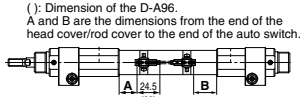

ø50 to ø63

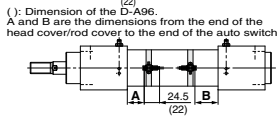

D-A9□V

ø20 to ø40

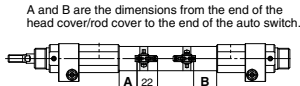

ø50 to ø63

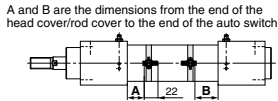

D-C7□, C80

ø20 to ø40

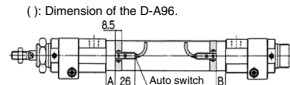

ø50 to ø63

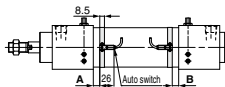

D-B5□, B64, B59W

ø20 to ø40

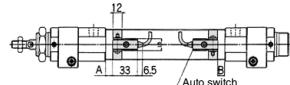

ø50 to ø63

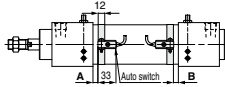

D-C73C, C80C

ø20 to ø40

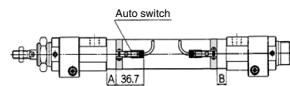

ø50 to ø63

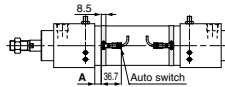

D-A3□, G39, K39

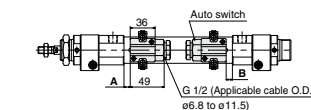

Solid state auto switch

D-M9□, M9□W, M9□A

ø20 to ø40

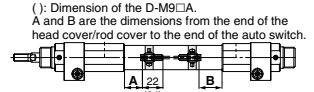

ø50 to ø63

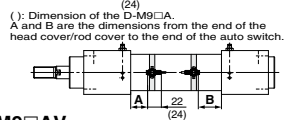

D-M9□V, M9□WV, M9□AV

ø20 to ø40

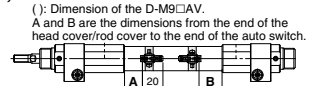

ø50 to ø63

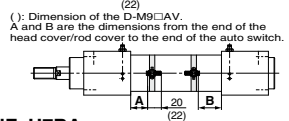

D-H7□, H7□W, H7NF, H7BA

ø20 to ø40

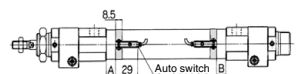

ø50 to ø63

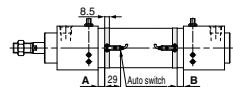

D-G5□, K59, G5□W, K59W, G5NT, G5BA

ø20 to ø40

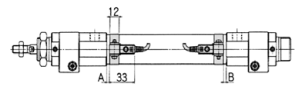

ø50 to ø63

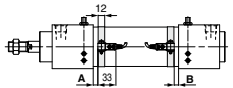

D-H7C

ø20 to ø40

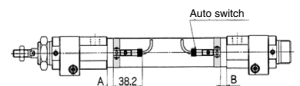

ø50 to ø63

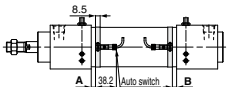

D-A44

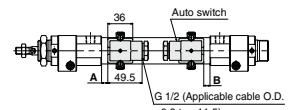

Auto Switch Proper Mounting Position (Detection at Stroke End) and Its Mounting Height

Auto Switch Proper Mounting Position

(mm)

Auto switch model Bore size (mm)	D-A9□ D-A9□V		D-M9□ D-M9□W D-M9□A D-M9□V D-M9□WV D-M9□AV		D-C7□ D-C80 D-C73C D-C80C		D-B5□ D-B64		D-H7□ D-H7C D-H7NF D-H7□W D-H7BA		D-G5□ D-G5□W D-G5NT D-G5BA D-K59 D-K59W		D-B59W		D-A33□ D-A44 D-G39 D-K39	
	A	B	A	B	A	B	A	B	A	B	A	B	A	B	A	B
20	14.5	20	18.5	24	15	20.5	9	14.5	14	19.5	10.5	16	12	17.5	8.5	14
25	14.5	20	18.5	24	15	20.5	9	14.5	14	19.5	10.5	16	12	17.5	8.5	14
32	14.5	22	18.5	26	15	22.5	9	16.5	14	21.5	10.5	18	12	19.5	8.5	16
40	19.5	27	23.5	31	20	27.5	14	21.5	19	26.5	15.5	23	17	24.5	13.5	21
50	17.5	27.5	21.5	31.5	18	28	12	22	17	27	13.5	23.5	15	25	11.5	21.5
63	17.5	27.5	21.5	31.5	18	28	12	22	17	27	13.5	23.5	15	25	11.5	21.5
80	—	—	—	—	—	—	13.5	27.5	—	—	15	29	16.5	30.5	13	27
100	—	—	—	—	—	—	15.5	29.5	—	—	17	31	18.5	32.5	15	29

Note) Adjust the auto switch after confirming the operating conditions in the actual setting.

Auto Switch Mounting Height

(mm)

Auto switch model Bore size (mm)	D-M9□V D-M9□WV D-M9□AV D-A9□V	D-M9□ D-M9□W D-M9□A D-A9□	D-H7□ D-H7□W D-H7NF D-H7BA D-C7/C8	D-B5□/B64 D-B59W D-G5□/K59 D-G5□W D-K59W D-G5NT D-G5BA D-H7C	D-C73C D-C80C	D-A3□ D-G39 D-K39	D-A44
	Hs	Hs	Hs	Hs	Hs	Hs	Hs
20	25.5	24.5	27.5	27	62	72	
25	28	27	30	29.5	64.5	74.5	
32	31.5	30.5	33.5	33	68	78	
40	36	35	38	37.5	72.5	82.5	
50	41.5	40.5	43.5	43	78	88	
63	48.5	47.5	50.5	50.5	85	95	
80	—	—	59	—	93.5	103.5	
100	—	—	69.5	—	104	114	

REA

REB

REC

Smooth

Low Speed

MQ

RHC

RZQ

D-□

-X□

Auto Switch Mounting 3

Operating Range

Auto switch model	Bore size (mm)							
	20	25	32	40	50	63	80	100
D-A9□(V)	7	6	8	8	8	9	—	—
D-M9□(V)								
D-M9□W(V)	3.5	3.5	4	4	5	5.5	—	—
D-M9□A(V)								
D-C7□/C80	8	10	9	10	10	11	—	—
D-C73C/C80C								
D-B5□/B64	8	10	9	10	10	11	11	11
D-B59W	13	13	14	14	14	17	16	18
D-H7□/H7NF/H7□W/H7BA	4	4	4.5	5	6	6.5	6.5	7
D-H7C	7	8.5	9	10	9.5	10.5	10.5	11
D-A3□/A44	9	10	9	10	10	11	11	11
D-G39/K39	8	9	9	9	9	10	10	11
D-G5□/K59/G5□W								
D-K59W/G5BA/G5NT	4	4	4.5	5	6	6.5	6.5	7

* Since this is a guideline including hysteresis, not meant to be guaranteed. (Assuming approximately ±30% dispersion.)
There may be the case it will vary substantially depending on an ambient environment.

Mounting Bracket Part No.

Auto switch model	Bore size (mm)							
	ø20	ø25	ø32	ø40	ø50	ø63	ø80	ø100
D-M9□(V)	Note 1)	Note 1)	Note 1)	Note 1)	Note 1)	Note 1)	—	—
D-M9□W(V)	BMA3-020	BMA3-025	BMA3-032	BMA3-040	BMA3-050	BMA3-063	—	—
D-A9□(V)								
D-M9□A(V)	Note 2)	Note 2)	Note 2)	Note 2)	Note 2)	Note 2)	—	—
	BMA3-020S	BMA3-025S	BMA3-032S	BMA3-040S	BMA3-050S	BMA3-063S	—	—
D-C7□/C80								
D-C73C/C80C								
D-H7□	BMA2-020A	BMA2-025A	BMA2-032A	BMA2-040A	BMA2-050A	BMA2-063A	—	—
D-H7□W								
D-H7NF								
D-H7BA								
D-B5□/B64								
D-B59W								
D-G5□/K59	BA-01	BA-02	BA-32	BA-04	BA-05	BA-06	BA-08	BA-10
D-G5□W/K59W								
D-G5BAL/G59F								
D-G5NT								
D-A3□/A44	BD1-01M	BD1-02M	BD1-02	BD1-04M	BD1-05M	BD1-06M	BD1-08M	BD1-10M
D-G39/K39								

Note 1) Set part number which includes the auto switch mounting band (BMA2-□□□□) and the holder kit (BJ5-1/Switch bracket: Transparent).

Since the switch bracket (made from nylon) are affected in an environment where alcohol, chloroform, methylamines, hydrochloric acid or sulfuric acid is splashed over, so it cannot be used. Please consult SMC regarding other chemicals.

Note 2) Set part number which includes the auto switch mounting band (BMA2-□□□□AS/Stainless steel screw) and the holder kit (BJ4-1/Switch bracket: White).

Note 3) For the D-M9□A(V) type auto switch, do not install the switch bracket on the indicator light.

[Mounting screw set made of stainless steel]

The following set of mounting screws made of stainless steel is available. Use it in accordance with the operating environment. (Please order the auto switch mounting bracket separately, since it is not included.)

BBA3: For D-B5/B6/G5/K5
BBA4: D-C7/C8/H7

The above stainless steel screws are used when a cylinder is shipped with the D-H7BA or G5BA auto switches.

When only an auto switch is shipped independently, the BBA3 or BBA4 is attached. Refer to pages 1047 and 1048 for details of the BBA1 and BBA3.

- 1) BJ□-1 is a set of "a" and "b".
BJ4-1 (Switch bracket: White)
BJ5-1 (Switch bracket: Transparent)
- 2) BMA2-□□□□A(S) is a set of "c" and "d".
Band (c) is mounted so that the projected part is on the internal side (contact side with the tube).

Other than the applicable auto switches listed in "How to Order", the following auto switches can be mounted. For detailed specifications, refer to pages 941 to 1067.

Type	Model	Electrical entry (Fatching direction)	Features	Applicable bore size (mm)
Reed	D-C73, C76	Grommet (In-line)	—	ø20 to ø63
	D-C80		Without indicator light	ø20 to ø100
	D-B53		—	ø20 to ø100
Solid state	D-H7A1, H7A2, H7B	Grommet (In-line)	—	ø20 to ø63
	D-H7NW, H7PW, H7BW		Diagnostic indication (2-color indicator)	ø20 to ø100
	D-G5NT		With timer	ø20 to ø100

* For solid state auto switches, auto switches with a pre-wired connector are also available. Refer to pages 1014 and 1015 for details.
* Normally closed (NC = b contact) solid state auto switches (D-F9G/F9H types) are also available. Refer to page 959 for details.

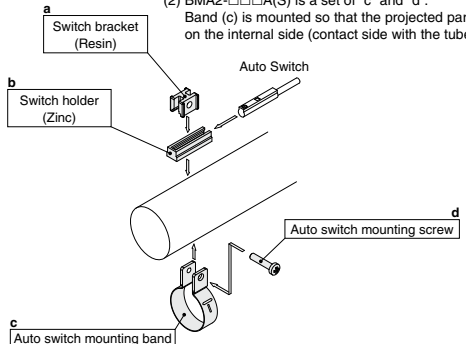



RHC Series Specific Product Precautions

Be sure to read this before handling the products.
Refer to back page 50 for Safety Instructions and pages 3 to 12 for Actuator and Auto Switch Precautions.

Mounting

Caution

Use an external guide, etc. for horizontal actuation of a load.

How to Rotate the Relief Valve Body (ø20, ø25, ø32, ø40)

Caution

The relief adjusting screw can be placed in any direction by rotating the relief valve body by following the steps given below.

Procedure

1. Verify that there is no residual pressure in the cylinder. Then, loosen the mounting bracket (such as foot, flange, etc.).
2. Loosen the set screw that is provided in the relief valve body retainer and rotate the relief valve body.
3. While keeping the relief valve body retainer pressed against the relief valve body, secure it with the set screw. After having secured the relief valve body retainer, make sure that the relief valve body cannot be rotated. In the event that it does rotate, loosen the set screw again and repeat the operation described in step 3.

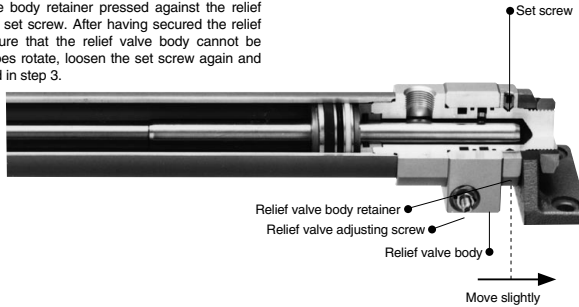

Handling

Caution

1. Confirm that the relief valve body does not rotate when the cylinder is mounted. If there is play in the axial direction of the relief valve body, the cushion may become ineffective. When attaching brackets (foot, flange), do so after loosening the relief valve body set screw. Retighten the relief valve body set screw after the brackets have been attached. (ø20, 25, 32, 40)
2. The cylinder stroke end cushion adjusting screw is adjusted six turns (10 turns for ø63, ø80 and ø100) starting from the position where it is rotated fully clockwise to counterclockwise (fully closed). It should never be rotated more than six turns (more than 10 turns for ø63, ø80 and ø100) from the position where it is rotated fully counterclockwise (fully open). This may damage the spring inside the relief valve.
3. The cylinder ports are designed so that a maximum speed 3000 mm/s can be obtained. However, it may not be possible to attain the desired speed in the case of short cylinder strokes. It may also be impossible to attain the desired speed due to restriction by component equipment (valves, speed control valves, piping, fitting, etc.). Make every effort to ensure sufficient effective area in the component equipment.
4. Avoid applications in which lateral loads are applied to the cylinder piston rod. Especially in the case of long strokes, implement measures such as providing a guide for the load.

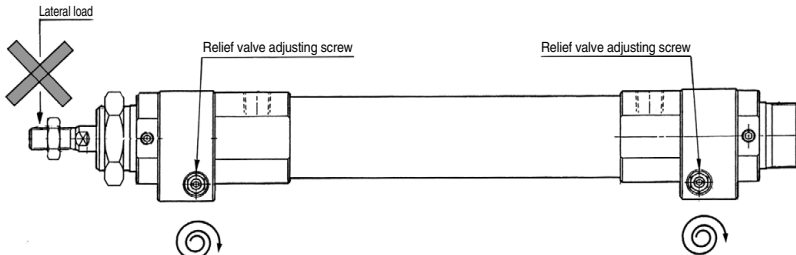

6 turns at most (ø20, 25, 32, 40, 50)
10 turns at most (ø63, 80, 100)

6 turns at most (ø20, 25, 32, 40, 50)
10 turns at most (ø63, 80, 100)

REA

REB

REC

Smooth

Low Speed

MQ

RHC

RZQ

D-□

-X□