

KP45 SERIES

Features

- 2-color digital LCD display
- Copy function
- Programmable pressure unit :
kPa 、 MPa 、 kgf/cm² 、 bar 、 psi 、 inHg
- IP65 enclosure



SPECIFICATIONS

TYPE	Compound	Vacuum	Positive
MODEL	KP45C	KP45V	KP45P
1.0 MPa			
100.0 kPa			
0			
-101.3 kPa			
Rated pressure range	-100.0 ~ 100.0 kPa	0.0 ~ -101.3 kPa	0.000 ~ 1.000 MPa
Setting pressure range	-101.0 ~ 101.0 kPa	10.0 ~ -101.3 kPa	-0.100 ~ 1.000 MPa

FEATURES HIGHLIGHT

1 Quick Installation

- Save installation time
- Easy removal

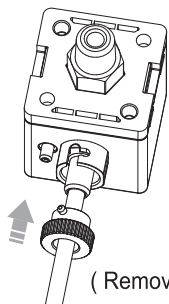

(Removable data cable)

2 Copy Setting

- Avoid setting errors
 - Reduce setting time
- Can copy the setting value from master to slave sensor.



(Original Parameter)

(Copied)

3 Easy Unit Identification

- Conversion unit is on display and easy to read.

inHg | psi | bar | kgf/cm² | MPa | kPa



4 2-Color Display

- User programmable color mode, for different setting conditions.



	5atf	5an	6ra	FFd
ON	Green	Red	Green	Red
OFF	Red	Green	Green	Red

5 IP65 Compliance

- Protected against water and dust splash from all directions.



6 Environmental Protection Design

- RoHS Compliance / Without Harmful Substance

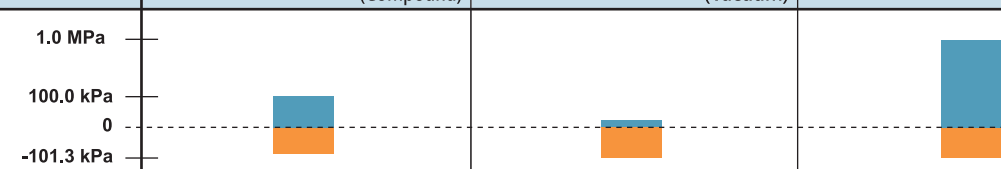

■ SPECIFICATIONS

MODEL		KP45C (Compound)	KP45V (Vacuum)	KP45P (Positive)
				
Rated pressure range		-100.0 ~ 100.0 kPa	0.0 ~ -101.3 kPa	0.000 ~ 1.000 MPa
Set pressure range		-101.0 ~ 101.0 kPa	10.0 ~ -101.3 kPa	-0.100 ~ 1.000 MPa
Withstand pressure		300 kPa		1.5 MPa
Fluid		Filtered air, Non-corrosive / Non-flammable gas		
Set pressure resolution	kPa	0.1		-
	MPa	-		0.001
	kgf/cm ²	0.001		0.01
	bar	0.001		0.01
	psi	0.01		0.1
	inHg	0.1		-
Power supply voltage		12 to 24V DC ±10%, Ripple (P-P) 10% or less		
Current consumption		≤ 40mA(With no load)		
Switch output		NPN: open collector 2 outputs Max. load current: 125mA Max. supply voltage: 30V DC Residual voltage: ≤ 1.5V		PNP: open collector 2 outputs Max. load current: 125mA Max. supply voltage: 24V DC Residual voltage: ≤ 1.5V
Repeatability(Switch output)		±0.2% F.S. ±1 digit		
Hysteresis	One point set mode	Adjustable(*1)		
	Hysteresis mode			
	Window comparator mode			
Response time		≤ 2.5ms (chattering-proof function: 25ms, 100ms, 250ms, 500ms, 1000ms and 1500ms selectable)		
Output short circuit protection		Yes		
7 segment LCD display		3½ digit, 7 segment (red/green)		
Indicator accuracy		±2% F.S. ±1 digit (ambient temperature: 25 ±3°C)		
Switch ON Indicator		Orange (1&2 Indicator) OUT1 OUT2		
Analog output (Voltage Output) (*2)		Output Voltage: 1 to 5V ±2.5% F.S. (within rated pressure range) Linearity: ±1% F.S. Output impedance: about 1kΩ		
Analog output (Current Output) (*3)		Output Current: 4 to 20mA ±2.5% F.S.(within rated pressure range) Linearity: ±1% F.S. Max.Load Impedance: 250Ω at power supply of 12V, 600Ω at power supply of 24V Min.Load impedance: 50Ω		
Environment	Environment	IP 65		
	Ambient temp. range	Operation: 0 ~ 50°C, Storage:-10 ~ 60°C (No condensation or freezing)		
	Ambient humidity range	Operation/Storage: 35 ~ 85% RH (No condensation)		
	Withstand voltage	1000V AC in 1-min (between case and lead wire)		
	Insulation resistance	50MΩ. (at 500V DC, between case and lead wire)		
	Vibration	Total amplitude 1.5mm or 10G,10Hz-55Hz-10Hz scan for 1 minute, two hours each direction of X, Y and Z		
	Shock	100m/s ² (10G), 3 times each in direction of X, Y and Z		
Temperature characteristic		±2.5% F.S. of detected pressure (25°C) at temp. Range of 0~50°C		
Port size		F1 : R1/8", M5; F2 : NPT1/8", #10-32 UNF; F3 : G1/8"(BSPP), M5		
Lead wire		Oil-resistance cable(0.15mm ²)		
Weight		Approx. 86g (with 2 meter lead wire)		

[NOTE] *1 : Hysteresis value is adjustable within 1 ~ 8 digits for one point set mode and window comparator mode.

*2 : If analog voltage output is selected, the analog current output cannot be selected at the same time.

*3 : If analog current output is selected, the analog voltage output cannot be selected at the same time.

KP45 SERIES

■ PANEL DESCRIPTION



■ INSTALLATION PRECAUTIONS

- When mounting, always use the wrench on the metallic area near the pressure port. Never apply a wrench to the plastic body, it will damage the sensor.
- Over tightening may cause damages to the port thread, mounting bracket and pressure sensor. Under tightening may result loosen or leakage.
- Apply pressure and power after installation and make necessary adjustments and inspect any possible signs of leakage to ensure proper installation.

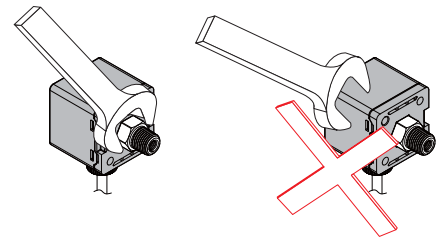

■ OUTPUT CIRCUIT WIRING DIAGRAMS

KP45 □ - 010 - □
2 NPN + Analog Output(1~5V)

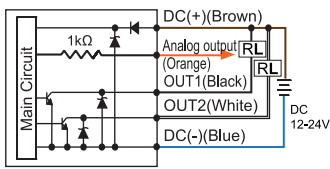

KP45 □ - 011 - □
2 NPN + Analog Output(4~20mA)

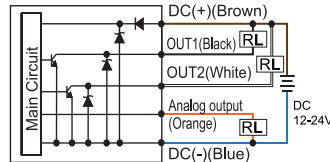

KP45 □ - 02 - □
2 NPN + Copy Function

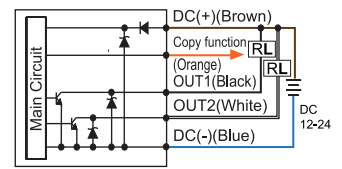

KP45 □ - 030 - □
2 PNP + Analog Output(1~5V)

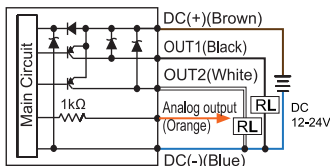

KP45 □ - 031 - □
2 PNP + Analog Output(4~20mA)

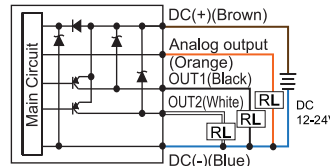

KP45 □ - 04 - □
2 PNP + Copy Function

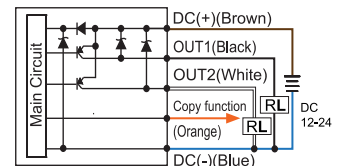

■ ORDERING INFORMATION

K P 4 5 C - 0 1 0 - F 1

Pressure Range

C : Compound (-101.0 ~ 101.0kPa)
V : Vacuum (10.0 ~ -101.3kPa)
P : Positive(-0.100~1.000MPa)

Output Specifications

010 : 2 NPN Output & Analog Output(1~5V)
011 : 2 NPN Output & Analog Output(4~20mA)
02 : 2 NPN Output & Copy Function
030 : 2 PNP Output & Analog Output(1~5V)
031 : 2 PNP Output & Analog Output(4~20mA)
04 : 2 PNP Output & Copy Function

Pressure Port

F1 : R1/8", M5
F2 : NPT1/8", #10-32UNF
F3 : G1/8"(BSPP), M5

Optional Parts

BT-10 : Mounting bracket
BT-11 : Mounting bracket
PA-E : Panel adapter
PA-F : Panel adapter + Front protective lid

Optional Parts

Mounting bracket

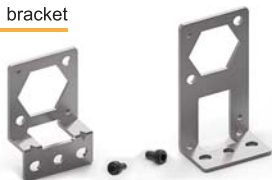

■ BT-10 ■ BT-11

Panel adapter



■ PA-E

Panel adapter + Front protective lid



■ PA-F

■ DIMENSIONS

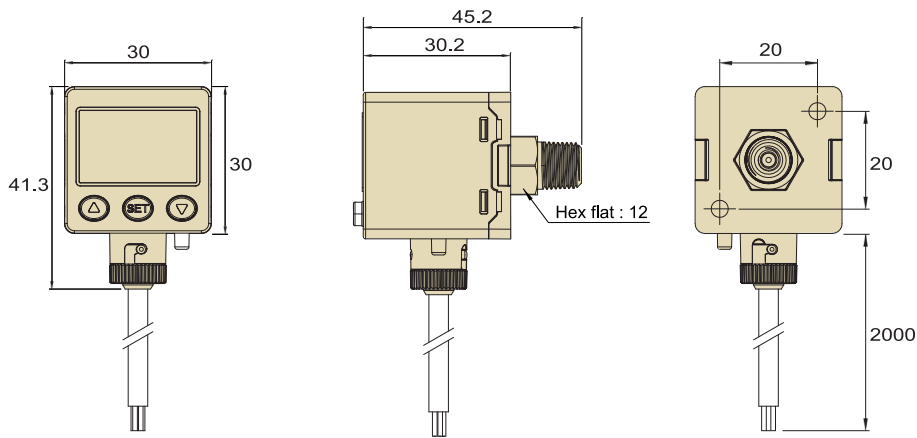

■ OPTIONAL PARTS DIMENSIONS

1 Mounting Bracket

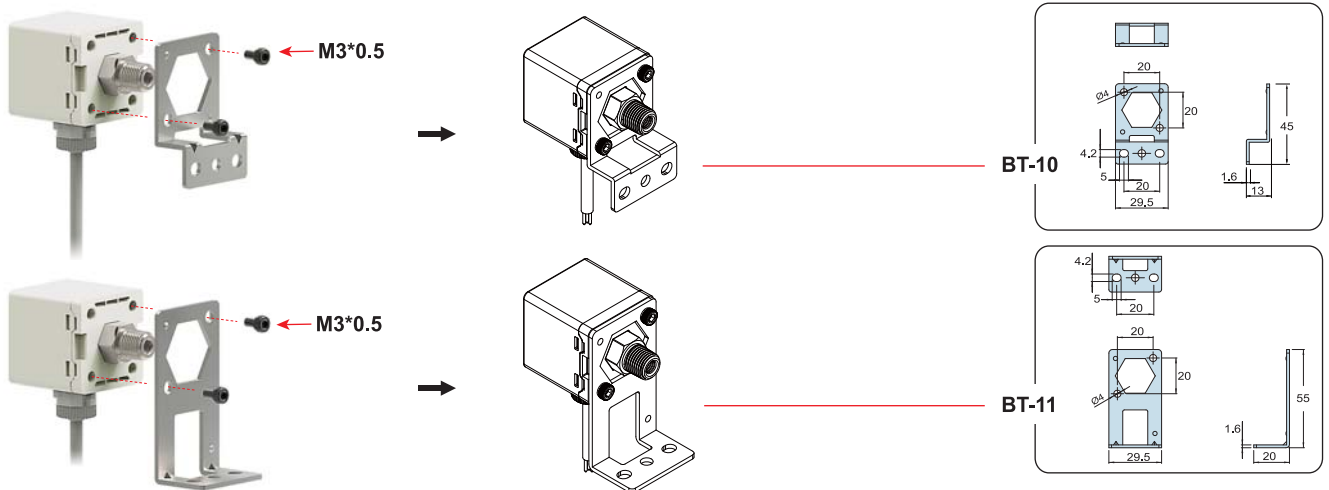

2 Panel Mount Adapter + Front Protective Lid

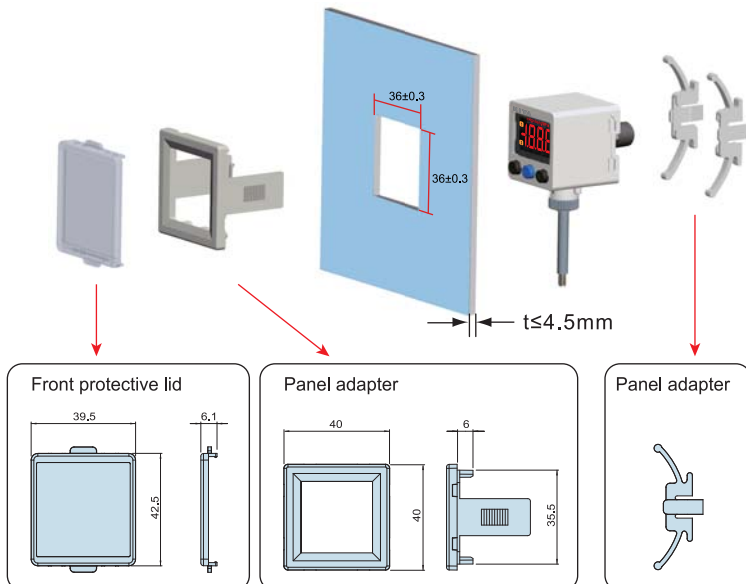

3 IP65 Protector

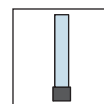
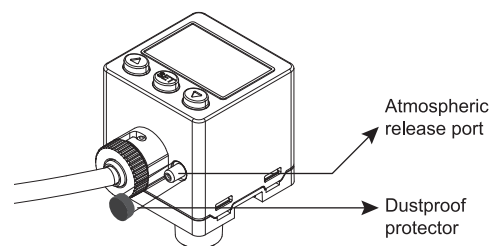

⚠ Caution:
This device must be installed to maintain IP 65 (Dust and splash proof) enclosure rating.

Unit:mm