

Rubber Seal 3 Port Pilot Solenoid Valve Series SYJ500

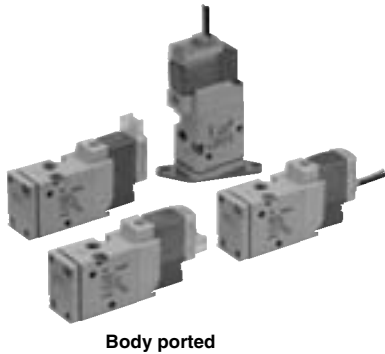

Body ported

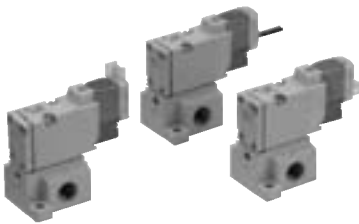

Base mounted

Specifications

Fluid	Air	
Operating pressure range (MPa)	Internal pilot	0.15 to 0.7
Ambient and fluid temperature (°C) -10 to 50 (No freezing.)		
Response time ms (at 0.5 MPa) ^{Note 1} 25 or less		
Max. operating frequency (Hz) 5		
Manual override (Manual operation) Non-locking push type, push-turn locking slotted type, push-turn locking lever type		
Pilot exhaust method Individual exhaust for the pilot valve, common exhaust for the pilot and main valve		
Lubrication Not required		
Mounting orientation Unrestricted		
Shock/Vibration resistance (m/s²) ^{Note 2} 150/30		
Enclosure Dust proof (* DIN terminal, M8 connector conforms to IP65.)		



* Based on IEC60529

Note 1) Based on dynamic performance test, JIS B 8374-1981. (Coil temperature: 20°C, at rated voltage, without surge voltage suppressor.)

Note 2) Impact resistance: No malfunction occurred when it is tested in the axial direction and at the right angles to the main valve and armature in both energized and de-energized states every once for each condition. (Value in the initial state)

Vibration resistance: No malfunction occurred in one sweep test between 45 and 2000 Hz. Test was performed at both energized and de-energized states in the axial direction and at the right angles to the main valve and armature. (Value in the initial state)

Solenoid Specifications

JIS Symbol

Internal pilot

SYJ51²/₄

SYJ52²/₄

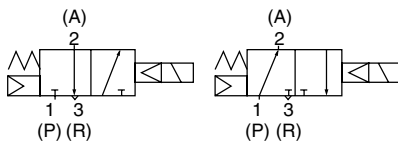

External pilot

SYJ51²/₄R

SYJ52²/₄R

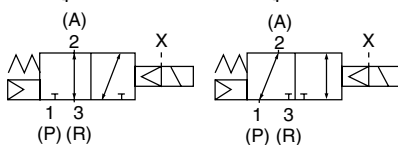

Electrical entry		Grommet (G), (H), L plug connector (L), M plug connector (M), DIN terminal (D), (Y), M8 connector (W)	
		G, H, L, M, W	D, Y
Coil rated voltage (V)	DC	24, 12, 6, 5, 3	24, 12
	AC 50/60 Hz	100, 110, 200, 220	
Allowable voltage fluctuation		±10% of rated voltage *	
Power consumption (W)	DC	Standard	0.35 (With light: 0.4 (DIN terminal with light: 0.45))
		With power saving circuit	0.1 (With light only)
Apparent power (VA) *	AC	100 V	0.78 (With light: 0.81) 0.78 (With light: 0.87)
		110 V [115 V]	0.86 (With light: 0.89) 0.86 (With light: 0.97) [0.94 (With light: 1.07)]
		200 V	1.18 (With light: 1.22) 1.15 (With light: 1.30)
		220 V [230 V]	1.30 (With light: 1.34) 1.27 (With light: 1.46) [1.42 (With light: 1.46)]
Surge voltage suppressor		Diode (DIN terminal, varistor when non-polar types)	
Indicator light		LED (Neon light when AC with DIN terminal)	



* In common between 110 VAC and 115 VAC, and between 220 VAC and 230 VAC.

* For 115 VAC and 230 VAC, the allowable voltage is -15% to +5% of rated voltage.

* S, Z and T type (with power saving circuit) should be used within the following allowable voltage fluctuation range due to a voltage drop caused by the internal circuit.

S and Z type: 24 VDC: -7% to +10%

12 VDC: -4% to +10%

T type: 24 VDC: -8% to +10%

12 VDC: -6% to +10%



Made to Order

(For details, refer to pages 1422 to 1423.)

Flow Characteristics/Mass

Valve model		Type of actuation	Port size	Flow characteristics						Mass (g) ^{Note)}			
				1→2 (P→A)			2→3 (A→R)			Grommet	L/M plug connector	DIN terminal	M8 connector
				C [dm ³ /(s·bar)]	b	Cv	C [dm ³ /(s·bar)]	b	Cv				
Body ported	SYJ512	N.C.	M5 x 0.8	0.53	0.45	0.14	0.47	0.39	0.12	46	47	68	51
	SYJ522	N.O.		0.66	0.45	0.18	0.66	0.45	0.18				
Base mounted (with sub-plate)	SYJ514	N.C.	1/8	1.2	0.41	0.32	1.1	0.46	0.32	60 (46)	61 (47)	82 (68)	65 (51)
	SYJ524	N.O.		1.3	0.37	0.33	1.2	0.48	0.34				



Note) Value for DC. Add 3 g for AC. (): Without sub-plate.

External Pilot

SYJ500R

Pilot valve pressure is supplied separately from the main valve pressure through the use of a separate supply port. It can be used in the vacuum (up to -100 kPa) or low pressure line with 0.15 MPa or less.

Specifications

Applicable model	Base mounted (SYJ514R, SYJ524R)	
Operating pressure range MPa	Main pressure	-100 kPa to 0.7
	External pilot pressure	0.15 to 0.7

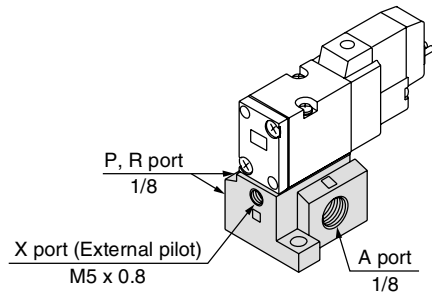

Note 1) For manifold base, refer to page 1392.

Note 2) External pilot type body ported valves (SYJ5□2R) can only be used on the manifold. For body ported models with the external pilot option, please refer to page 1423.

How to Order

Rated voltage

DC	
5	24 VDC
6	12 VDC
V	6 VDC
S	5 VDC
R	3 VDC

* DC specifications of type D, Y, DO and YO is only available with 12 and 24 VDC.

AC (50/60 Hz)	
1	100 VAC
2	200 VAC
3	110 VAC [115 VAC]
4	220 VAC [230 VAC]

* For type W□, DC voltage is only available.

Light/surge voltage suppressor

Nil	Without light/surge voltage suppressor
S	With surge voltage suppressor
Z	With light/surge voltage suppressor
R	With surge voltage suppressor (Non-polar type)
U	With light/surge voltage suppressor (Non-polar type)

* For AC voltage valves there is no "S" option. It is already built-in to the rectifier circuit.
* For type "R" and "U", DC voltage is only available.
* Power saving circuit is only available in the "Z" type.

Electrical entry for D, Y

Nil	Without light/surge voltage suppressor
S	With surge voltage suppressor (Non-polar type)
Z	With light/surge voltage suppressor (Non-polar type)

* DOZ and YOZ are not available.
* For AC voltage valves there is no "S" option. It is already built-in to the rectifier circuit.

Type of actuation

1	Normally closed
2	Normally open

Bracket

Nil	Without bracket
F	With bracket

* Bracket is not mounted.
* External pilot type is compatible with the Made-to-Order specifications (-X20).

Made to Order

Nil	—
X20	Body ported external pilot

(Refer to page 1423.)

Body ported SYJ5 1 2 □ □ - 5 M □ □ - M5 - □ □ - □ □

Base mounted SYJ5 1 4 □ □ - 5 M □ □ - 01 □ □ - □ □

Coil specifications

Nil	Standard
T	With power saving circuit (24, 12 VDC only)

* Power saving circuit is not available in the case of D, Y, DO, YO or W□ type.

Manual override

Nil: Non-locking push type

D: Push-turn locking slotted type

E: Push-turn locking lever type

Port size

Nil: Without sub-plate 01: 1/8 port With sub-plate

Thread type

Nil	Rc
F	G
N	NPT
T	NPTF

CE-complaint

Nil	—
Q	CE-complaint

* CE-compliant: For DC only.

Electrical entry

24, 12, 6, 5, 3 VDC/100, 110, 200, 220 VAC				24, 12 VDC/100, 110, 200, 220 VAC		24, 12, 6, 5, 3 VDC
Grommet	L plug connector	M plug connector		DIN terminal		M8 connector
G: Lead wire length 300 mm	L: With lead wire (Length 300 mm)	M: With lead wire (Length 300 mm)	MN: Without lead wire	D: With connector	Y: With connector	WO: Without connector cable
H: Lead wire length 600 mm	LN: Without lead wire	LO: Without connector	MO: Without connector	DO: Without connector	YO: Without connector	W□: With connector cable (Note 1)

Note) When placing an order for body ported solenoid valve as a single unit, mounting screws for manifold and gasket are not attached. Order them separately, if necessary. (For details, refer to page 1393.)

* LN, MN type: with 2 sockets.
* Refer to page 1425 for the lead wire length of L and M plug connectors.
* Refer to page 1428 for the connector assembly with cover for L and M plug connectors.

* DIN terminal type "Y" which conforms to EN-175301-803C (former DIN43650C) is also available. For details, refer to page 1427.
* For connector cable of M8 connector, refer to page 1429.
* A M8 connector conforming to IEC60947-5-2 is also available. Refer to page 1422 for details.
Note 1) Enter the cable length symbols in □. Please be sure to fill in the blank referring to page 1429.

Body option

Nil: Individual pilot exhaust type

M: Common exhaust for the pilot and main valve

R: External pilot type*

* SYJ5□2R is only for manifold use.

3 port

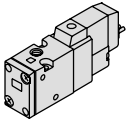

(For manifold type 20, 21R)

3 port

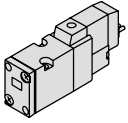

(For sub-plate style, manifold type 40, 40R, 41, 41R)

Construction

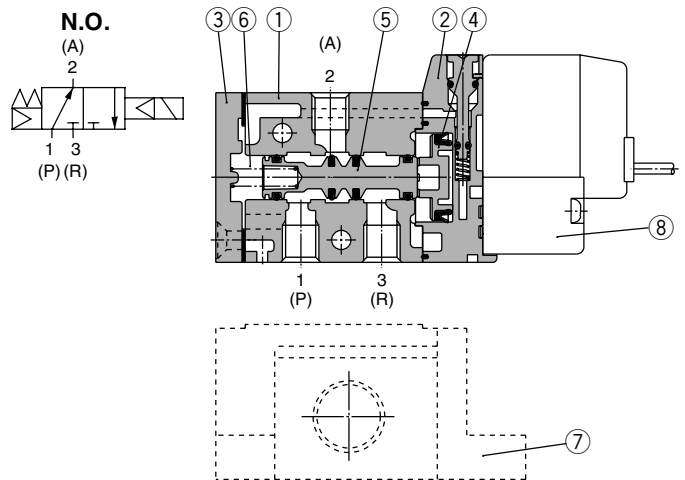
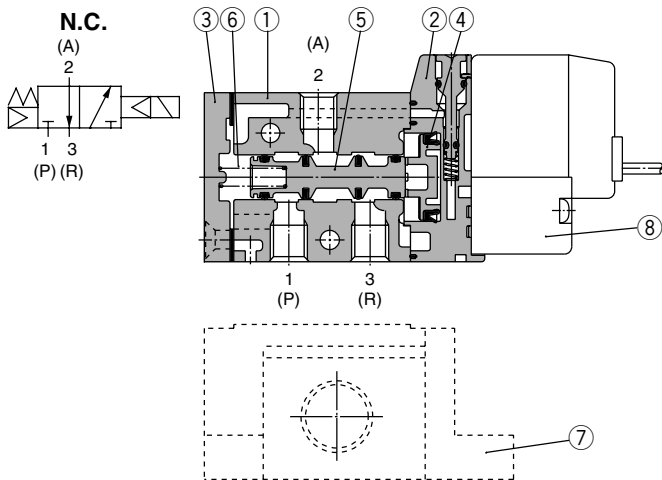

Component Parts

No.	Description	Material	Note
1	Body	Aluminum die-casted	White
2	Piston plate	Resin	White
3	End cover	Aluminum die-casted	White
4	Piston	Resin	—
5	Spool valve assembly	—	—
6	Spool spring	Stainless steel	—

Replacement Parts

No.	Description	Part no.	Note
7	Sub-plate ^{Note)}	SYJ500-9-1(-Q)	Zinc die-casted
8	Pilot valve	V111(T)-□□□□	
—	Bracket assembly	SYJ5000-13-3A	

Note) Add suffix "-Q" for the CE-compliant product.

How to Order Pilot Valve Assembly

V111 □ — 5 G □

Coil specifications

Nil	Standard
T	With power saving circuit (24, 12 VDC only)

* Power saving circuit is not available in the case of W□ type.

Rated voltage

5	24 VDC
6	12 VDC
V	6 VDC
S	5 VDC
R	3 VDC
1	100 VAC 50/60 Hz
2	200 VAC 50/60 Hz
3	110 VAC 50/60 Hz [115 VAC 50/60 Hz]
4	220 VAC 50/60 Hz [230 VAC 50/60 Hz]

* For type W□, DC voltage is only available.
* CE-compliant: For DC only.

Light/surge voltage suppressor

Nil	Without light/surge voltage suppressor
S	With surge voltage suppressor
Z	With light/surge voltage suppressor
R	With surge voltage suppressor (Non-polar type)
U	With light/surge voltage suppressor (Non-polar type)

* For AC voltage valves there is no "S" option. It is already built-in to the rectifier circuit.
* For "R" and "U", DC voltage is only available.
* Power saving circuit is only available in the "Z" type.

Electrical entry

G	Grommet, 300 mm lead wire
H	Grommet, 600 mm lead wire
L	With lead wire
LN	L plug connector
LO	Without connector
M	With lead wire
MN	M plug connector
MO	Without connector
WO	M8 connector
W□	Without connector cable
W□	With connector cable ^{Note 1)}

* For connector cable of M8 connector, refer to page 1429.
Note 1) Enter the cable length symbols in □. Please be sure to fill in the blank referring to page 1429.

V115 — 5 D □

Light/surge voltage suppressor

Nil	Without light/surge voltage suppressor
S	With surge voltage suppressor (Non-polar type)
Z	With light/surge voltage suppressor (Non-polar type)

* DOZ and YOZ are not available.
* For AC voltage valves there is no "S" option. It is already built-in to the rectifier circuit.

Electrical entry

D	DIN terminal	With connector
DO	(Type D)	Without connector
Y	DIN terminal	With connector
YO	(Type Y)	Without connector

* Do not replace V111 (G, H, L, M, W) to V115 (DIN terminal) and vice versa when replacing pilot valve assembly only.

Rated voltage

5	24 VDC
6	12 VDC
1	100 VAC 50/60 Hz
2	200 VAC 50/60 Hz
3	110 VAC 50/60 Hz [115 VAC 50/60 Hz]
4	220 VAC 50/60 Hz [230 VAC 50/60 Hz]

* DC specifications of type D and DO is only available with 12 and 24 VDC.
* Power saving circuit is not available in the case of D or DO type.

Since V111 and V115 are CE-compliant as standard, the suffix "-Q" is not necessary.

Series SYJ500

Body Ported

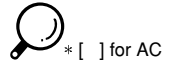

Grommet (G), (H): SYJ5□2-□^G□□-M5

With bracket:
SYJ5□2-□^G□□-M5-F

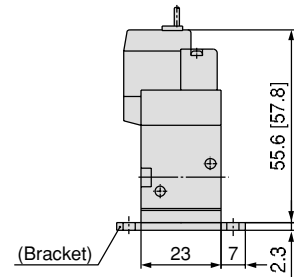
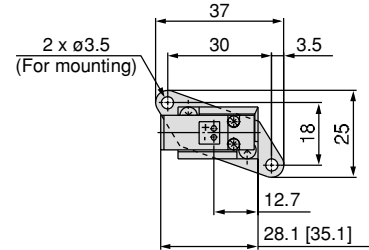
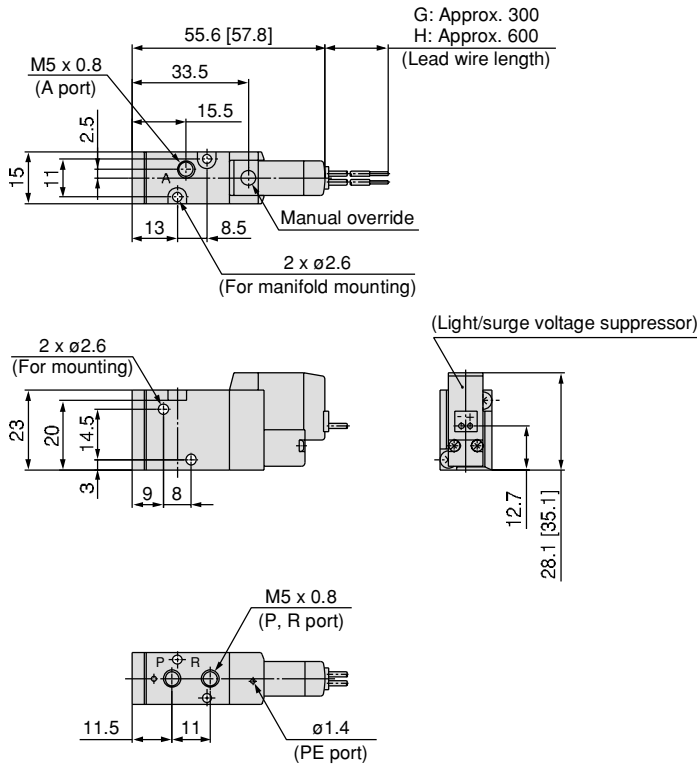

L plug connector (L):
SYJ5□2-□L□□-M5 (-F)

M plug connector (M):
SYJ5□2-□M□□-M5 (-F)

DIN terminal (D, Y):
SYJ5□2-□D□□-M5 (-F)

M8 connector (WO):
SYJ5□2-□WO□□-M5 (-F)

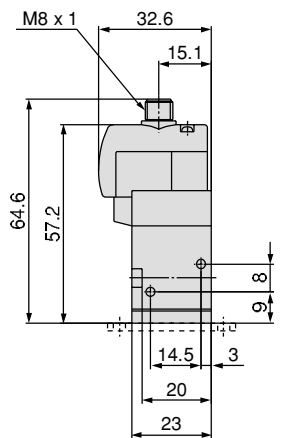
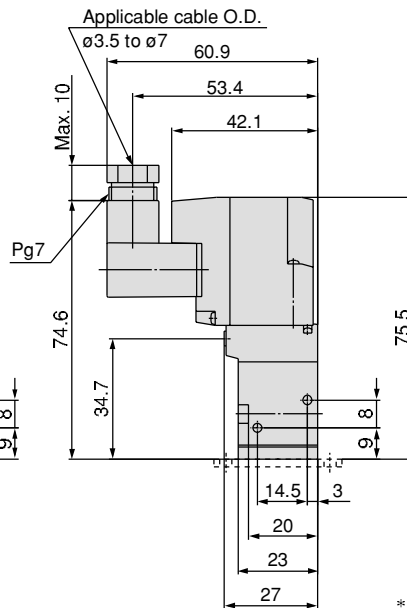
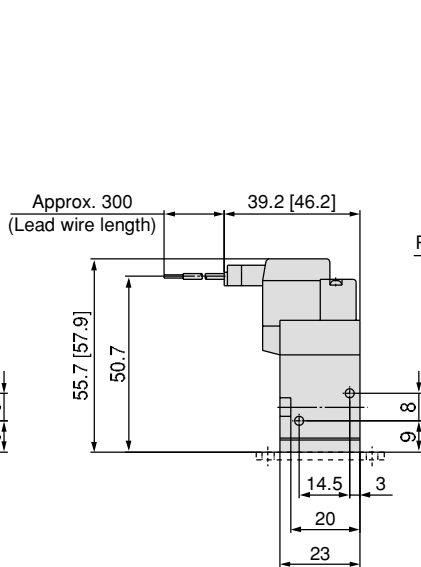
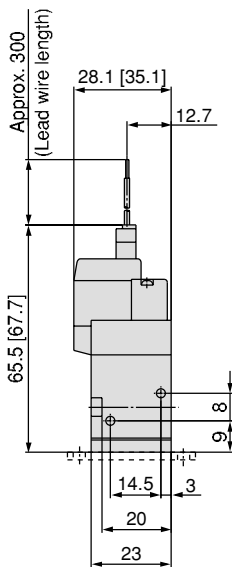

* Refer to page 1429 for dimensions with connector cable.

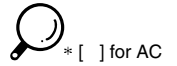

Base Mounted (With Sub-plate)

Grommet (G), (H): SYJ5□4-□^G□□-01□

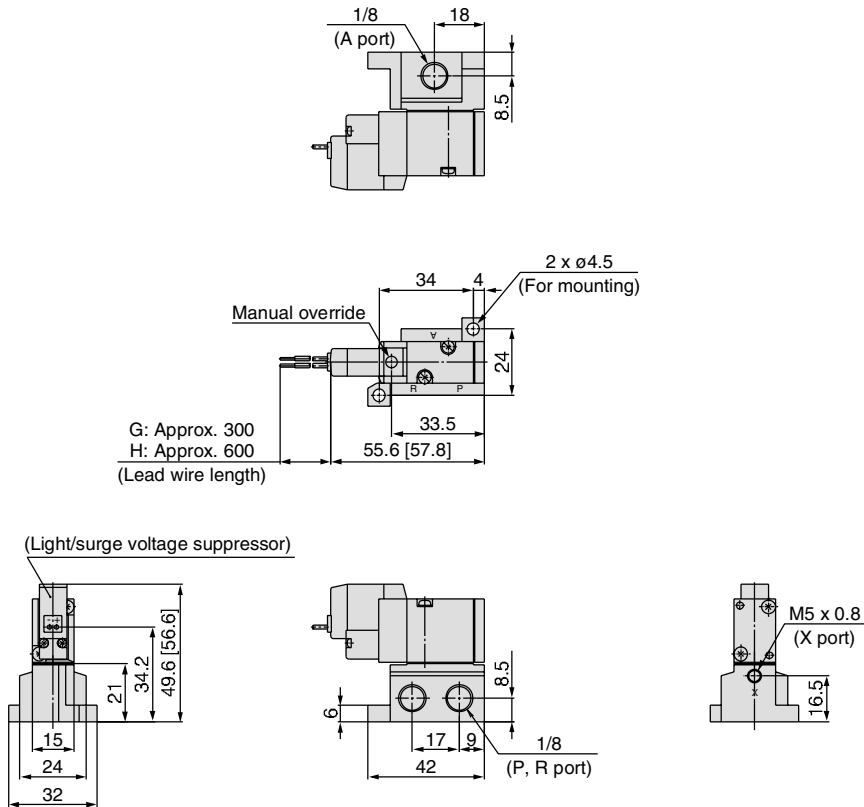

L plug connector (L):
SYJ5□4-□L□□-01□

M plug connector (M):
SYJ5□4-□M□□-01□

DIN terminal (D, Y):
SYJ5□4-□^D□□-01□

M8 connector (WO):
SYJ5□4-□WO□□-01□

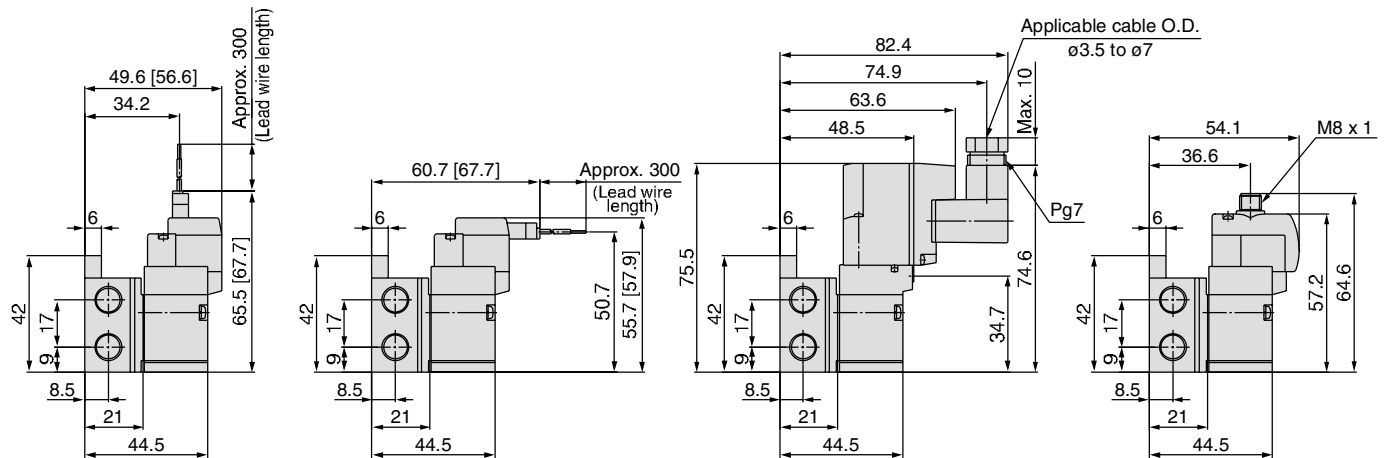

* Refer to page 1429 for dimensions with connector cable.

Series SYJ500 Manifold Specifications



Manifold Specifications

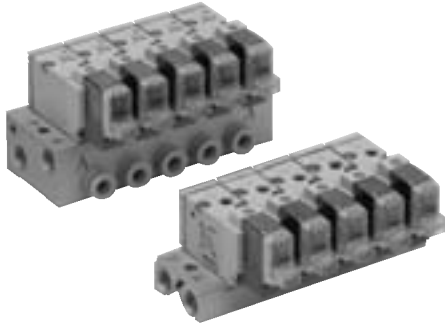

Model	For internal pilot	Type 20	Type 40	Type 41
	For external pilot	Type 21R	Type 40R	Type 41R
Manifold type	Single base/B mount			
P (SUP), R (EXH)	Common SUP, common EXH			
Valve stations	2 to 20 stations			
A port Porting specifications	Location	Valve	Base	
	Direction	Top	Bottom	Side
Port size	P, R port	1/8	1/8	1/8
	A port	M5 x 0.8	M5 x 0.8 1/8	M5 x 0.8, 1/8, C4 (One-touch fitting for ø4), C6 (One-touch fitting for ø6)
	X port <small>Note</small>	M5 x 0.8	M5 x 0.8	M5 x 0.8

Note) Only for external pilot

Flow Characteristics

Manifold			Port size		Flow characteristics					
					1→2 (P→A)			2→3 (A→R)		
1(P), 3(R) port	2(A) port		C [dm ³ /(sbar)]	b	Cv	C [dm ³ /(sbar)]	b	Cv		
Body ported for internal pilot	Type SS3YJ5-20	SYJ5□2	1/8	M5 x 0.8	0.47	0.43	0.13	0.74	0.32	0.19
	Type SS3YJ5-40-M5	SYJ5□4	1/8	M5 x 0.8	0.71	0.52	0.21	0.81	0.28	0.20
Type SS3YJ5-40-01	1/8		1/8	0.98	0.36	0.25	0.92	0.24	0.22	
Type SS3YJ5-41-M5	1/8		M5 x 0.8	0.71	0.49	0.20	0.80	0.23	0.19	
Type SS3YJ5-41-01	1/8		1/8	1.0	0.37	0.26	0.96	0.25	0.24	
Type SS3YJ5-41-C4	1/8		C4	0.68	0.35	0.17	1.0	0.25	0.24	
Type SS3YJ5-41-C6	1/8		C6	1.0	0.27	0.25	1.0	0.30	0.26	
Body ported for external pilot	Type SS3YJ5-21R	SYJ5□2R	1/8	M5 x 0.8	0.47	0.43	0.13	0.74	0.32	0.19
	Type SS3YJ5-40R-M5	SYJ5□4R	1/8	M5 x 0.8	0.71	0.52	0.21	0.81	0.28	0.20
Type SS3YJ5-40R-01	1/8		1/8	0.98	0.36	0.25	0.92	0.24	0.22	
Type SS3YJ5-41R-M5	1/8		M5 x 0.8	0.71	0.49	0.20	0.80	0.23	0.19	
Type SS3YJ5-41R-01	1/8		1/8	1.0	0.37	0.26	0.96	0.25	0.24	
Type SS3YJ5-41R-C4	1/8		C4	0.68	0.35	0.17	1.0	0.25	0.24	
Type SS3YJ5-41R-C6	1/8		C6	1.0	0.27	0.25	1.0	0.30	0.26	

Note) Value at manifold base mounted, 2 position single operating

How to Order Manifold (Example)

Instruct by specifying the valves and blanking plate assembly to be mounted on the manifold along with the manifold base model no.

(Example)

SS3YJ5-20-03 1 set (manifold base) SS3YJ5-41R-03-C6 1 set (manifold base)

* SYJ512-5LZ-M5 2 sets (valve) SYJ514R-5G 2 sets (valve)

* SYJ500-10-1A 1 set (blanking plate assembly) SYJ500-10-3A 1 set (blanking plate assembly)

↳ The asterisk denotes the symbol for assembly. Prefix it to the part nos. of the solenoid valve, etc.

Combinations of Solenoid Valve, Manifold Gasket and Manifold Base

Blanking Plate Assembly

Body ported (Type SYJ5□2(R)(-Q))

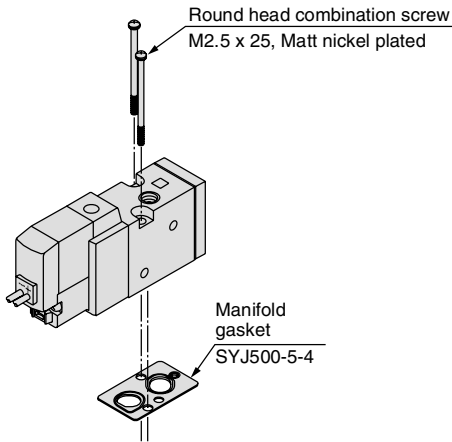

Applicable base
Type SS3YJ5-21R(-Q)
Type SS3YJ5-20(-Q)
Manifold base

Base mounted (Type SYJ5□4(R)(-Q))

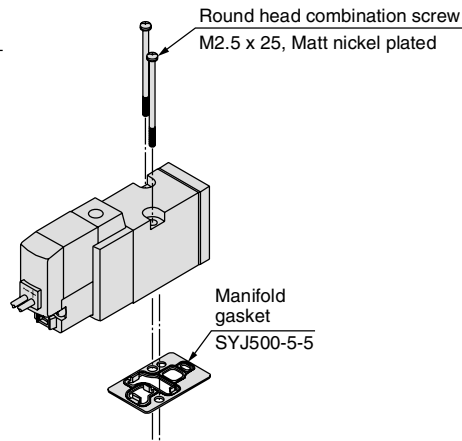

Applicable base
Sub-plate
Type SS3YJ5-40(-Q)
Type SS3YJ5-41(-Q)
Type SS3YJ5-40R(-Q)
Type SS3YJ5-41R(-Q) } Manifold base

Part no.: SYJ500-10-3A(-Q)

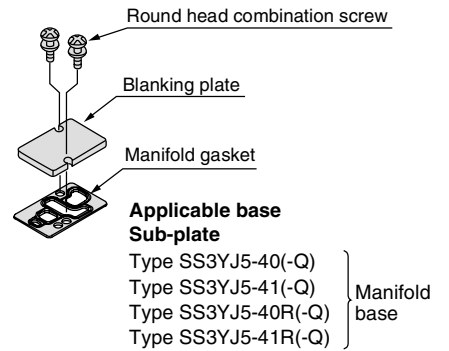

Applicable base
Sub-plate
Type SS3YJ5-40(-Q)
Type SS3YJ5-41(-Q)
Type SS3YJ5-40R(-Q)
Type SS3YJ5-41R(-Q) } Manifold base

Part no.: SYJ500-10-1A(-Q)

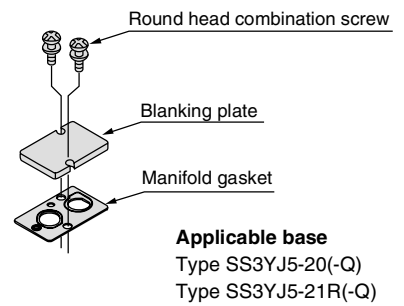

Applicable base
Type SS3YJ5-20(-Q)
Type SS3YJ5-21R(-Q)

Caution

Mounting screw tightening torques

M2.5: 0.45 N-m

Use caution to the assembly orientation for solenoid valves (blanking plate) and manifold gasket.



Note) Add suffix "-Q" for the CE-compliant product.

Series SYJ500

Manifold for Internal Pilot Type

Type 20

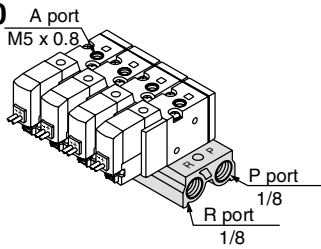

How to Order

SS3YJ5 - 20 - 05 - [] - [] - []

• Stations

02	2 Stations
:	:
20	20 Stations

• P, R port thread type

Nil	Rc
00F	G
00N	NPT
00T	NPTF

Bracket

Nil	Without bracket
F	With bracket

CE-complaint

Nil	—
Q	CE-complaint

Applicable solenoid valve
SYJ512-□□□□-M5(-Q)
SYJ512M-□□□□-M5(-Q)
SYJ522-□□□□-M5(-Q)
SYJ522M-□□□□-M5(-Q)

Applicable blanking plate assembly
Refer to page 1393.

Note) For more than 6 stations, supply air to both sides of P port and exhaust air from both sides of R port.

Type 40

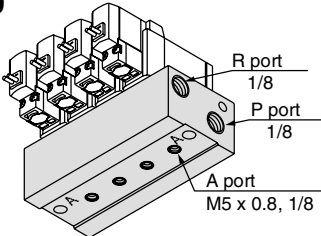

How to Order

SS3YJ5 - 40 - 05 M5 - [] - []

• Stations

02	2 Stations
:	:
20	20 Stations

• A port size

M5	M5 x 0.8
01	1/8

• P, R port thread type

Nil	Rc
F	G
N	NPT
T	NPTF

CE-complaint

Nil	—
Q	CE-complaint

Applicable solenoid valve
SYJ514-□□□□(-Q)
SYJ514M-□□□□(-Q)
SYJ524-□□□□(-Q)
SYJ524M-□□□□(-Q)

Applicable blanking plate assembly
Refer to page 1393.

Note) For more than 9 stations, supply air to both sides of P port and exhaust air from both sides of R port.

Type 41

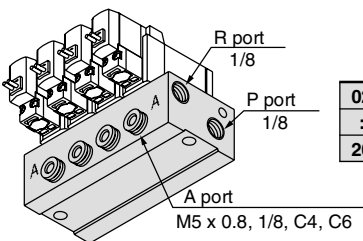

How to Order

SS3YJ5 - 41 - 05 - C6 - [] - []

Stations

02	2 Stations
:	:
20	20 Stations

A port size

M5	M5 x 0.8
01	1/8
C4	ø4 one-touch fitting
C6	ø6 one-touch fitting
N3	ø5/32" one-touch fitting
N7	ø1/4" one-touch fitting

• P, R port thread type

Nil	Rc
F	G
N	NPT
T	NPTF

CE-complaint

Nil	—
Q	CE-complaint

Applicable solenoid valve
SYJ514-□□□□(-Q)
SYJ514M-□□□□(-Q)
SYJ524-□□□□(-Q)
SYJ524M-□□□□(-Q)

Applicable blanking plate assembly
Refer to page 1393.

Note) For more than 9 stations, supply air to both sides of P port and exhaust air from both sides of R port.

Manifold for External Pilot Type

Pilot valve pressure is supplied separately from the main valve pressure through the use of a separate supply port. It can be used in the vacuum (up to -100 kPa) or low pressure line with 0.15 MPa or less.

Type 21R

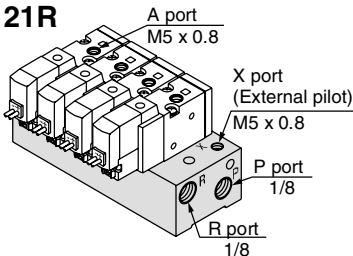

How to Order

SS3YJ5 - 21R - 05 - [] - []

• Stations

02	2 Stations
:	:
20	20 Stations

• P, R port thread type

Nil	Rc
00F	G
00N	NPT
00T	NPTF

CE-complaint

Nil	—
Q	CE-complaint

Applicable solenoid valve
SYJ512R-□□□□-M5(-Q)
SYJ522R-□□□□-M5(-Q)

Applicable blanking plate assembly
Refer to page 1393.

Note) For more than 9 stations, supply/exhaust air to/from both sides of P and R port.

Type 40R

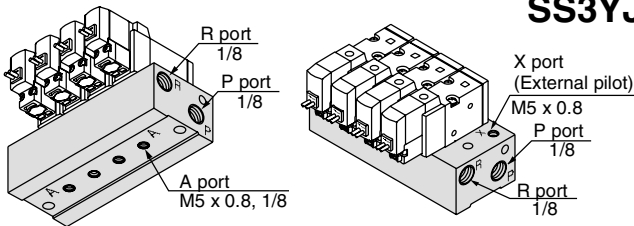

How to Order

SS3YJ5 - 40R - 05 - 01 - [] - []

• Stations

02	2 Stations
:	:
20	20 Stations

• A port size

M5	M5 x 0.8
01	1/8

P, R port thread type

Nil	Rc
F	G
N	NPT
T	NPTF

CE-complaint

Nil	—
Q	CE-complaint

Applicable solenoid valve
SYJ514R-□□□□(-Q)
SYJ524R-□□□□(-Q)

Applicable blanking plate assembly
Refer to page 1393.

Note) For more than 9 stations, supply/exhaust air to/from both sides of P and R port.

Type 41R

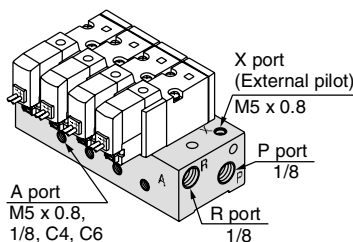

How to Order

SS3YJ5 - 41R - 05 - M5 - [] - []

Stations

02	2 Stations
:	:
20	20 Stations

A port size

M5	M5 x 0.8
01	1/8
C4	ø4 one-touch fitting
C6	ø6 one-touch fitting
N3	ø5/32" one-touch fitting
N7	ø1/4" one-touch fitting

• P, R port thread type

Nil	Rc
F	G
N	NPT
T	NPTF

CE-complaint

Nil	—
Q	CE-complaint

Applicable solenoid valve
SYJ514R-□□□□(-Q)
SYJ524R-□□□□(-Q)

Applicable blanking plate assembly
Refer to page 1393.

Note) For more than 9 stations, supply/exhaust air to/from both sides of P and R port.

Type 20 Manifold: Top Ported/SS3YJ5-20-**Stations**-00 □ (-F)

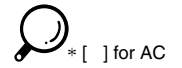

Grommet (G)

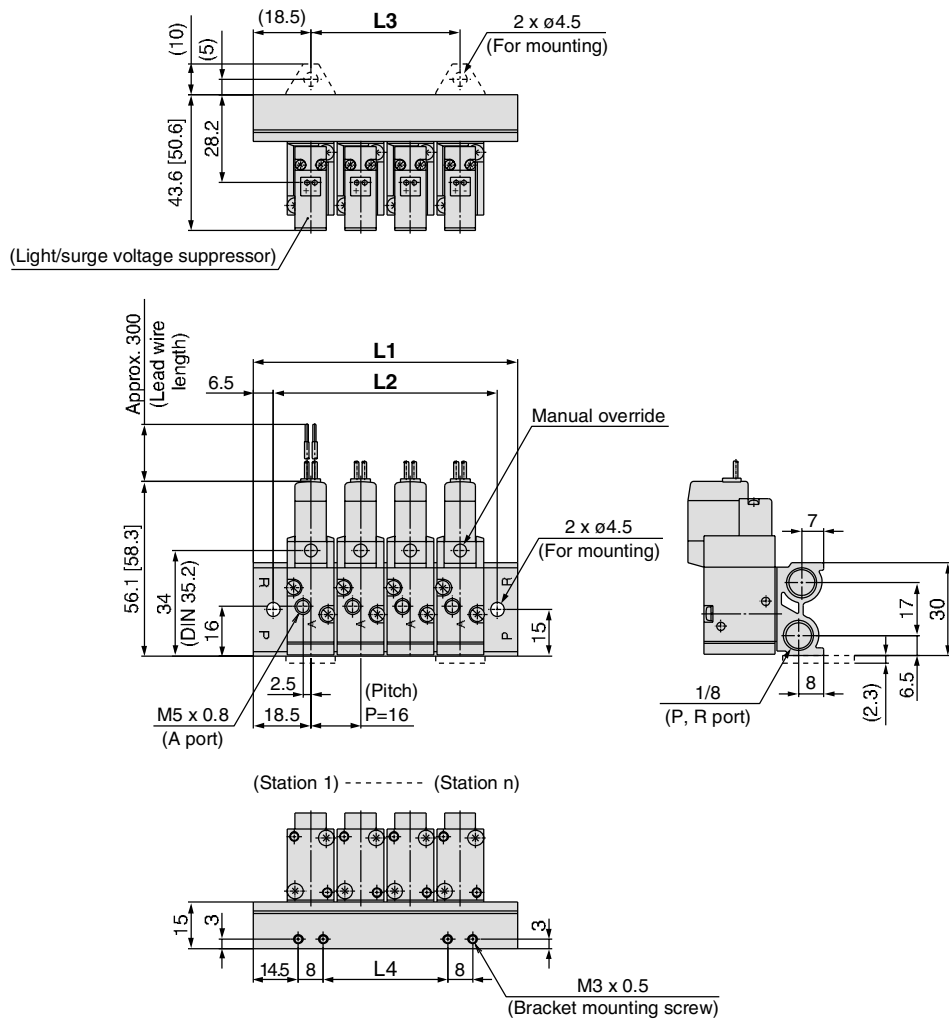

L plug connector (L)

M plug connector (M)

DIN terminal (D, Y)

M8 connector (WO)

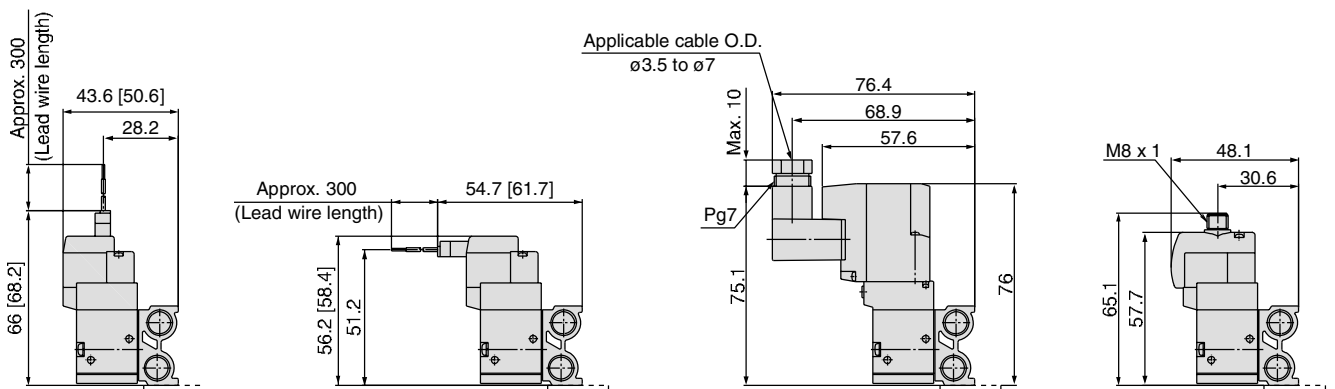

* Refer to page 1429 for dimensions with connector cable.

Station n	Station 2	3	4	5	6	7	8	9	10	11	12	13	14	15	16	17	18	19	Station 20
L1	53	69	85	101	117	133	149	165	181	197	213	229	245	261	277	293	309	325	341
L2	40	56	72	88	104	120	136	152	168	184	200	216	232	248	264	280	296	312	328
L3	16	32	48	64	80	96	112	128	144	160	176	192	208	224	240	256	272	288	304
L4	8	24	40	56	72	88	104	120	136	152	168	184	200	216	232	248	264	280	296

Series SYJ500

Type 40 Manifold: Top Ported/SS3YJ5-40- Stations -M5, 01 □



Grommet (G)

For M5

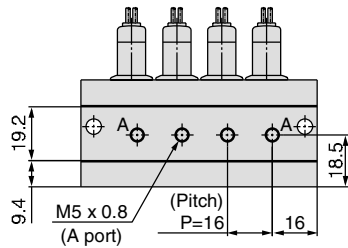
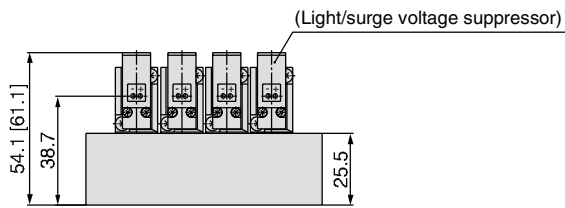
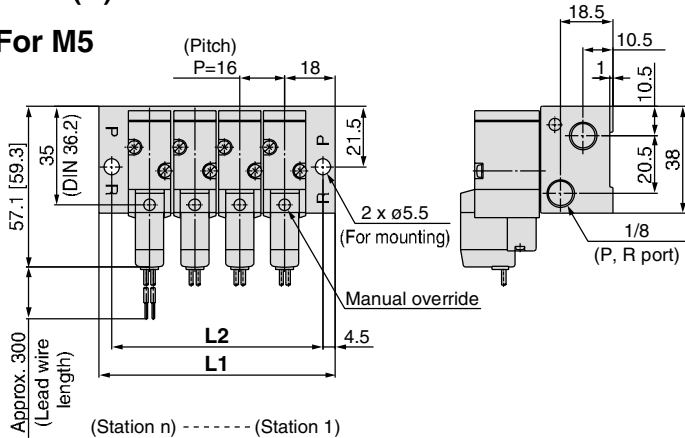

For 1/8

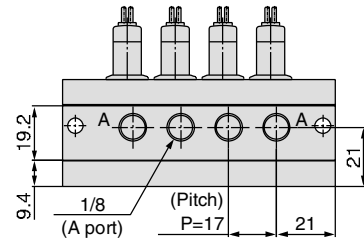
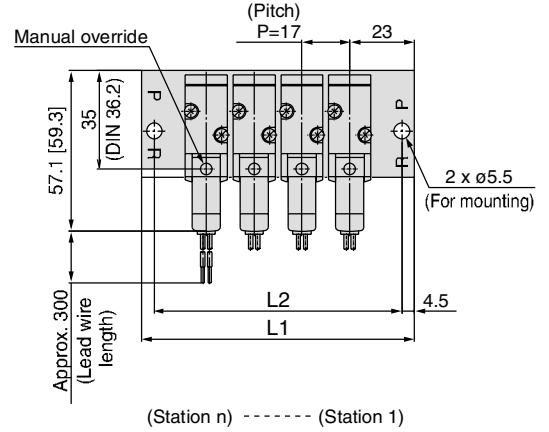

L plug connector (L)

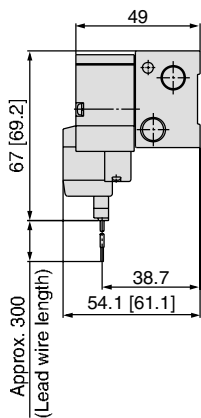

M plug connector (M)

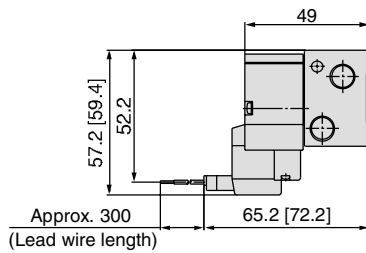

DIN terminal (D, Y)

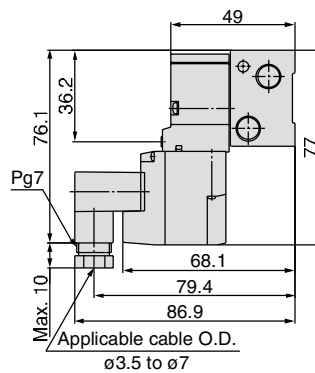

M8 connector (WO)

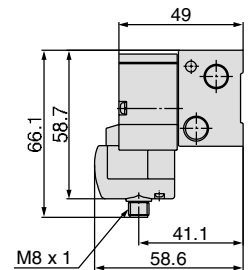

* Refer to page 1429 for dimensions with connector cable.

Port size	Station n	Station 2	3	4	5	6	7	8	9	10	11	12	13	14	15	16	17	18	19	Station 20
M5	L1	52	68	84	100	116	132	148	164	180	196	212	228	244	260	276	292	308	324	340
	L2	43	59	75	91	107	123	139	155	171	187	203	219	235	251	267	283	299	315	331
1/8	L1	63	80	97	114	131	148	165	182	199	216	233	250	267	284	301	318	335	352	369
	L2	54	71	88	105	122	139	156	173	190	207	224	241	258	275	292	309	326	343	360

Type 41 Manifold: Side Ported/SS3YJ5-41- **Stations** C4, N3
 C6, N7



Grommet (G)

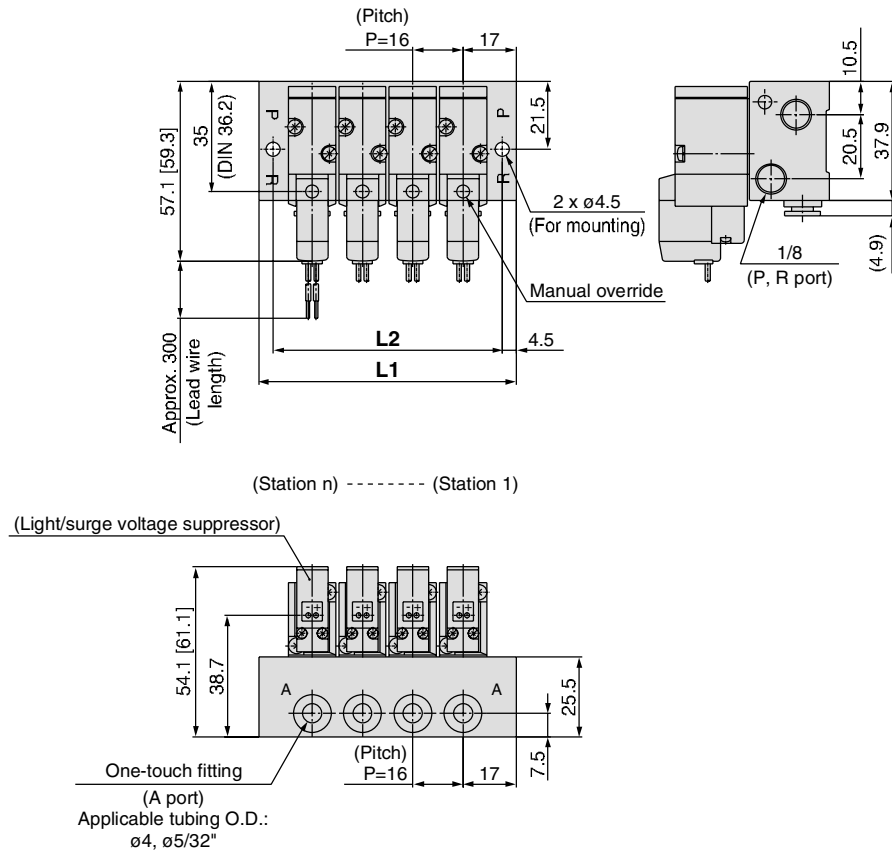

L plug connector (L)

M plug connector (M)

DIN terminal (D, Y)

M8 connector (WO)

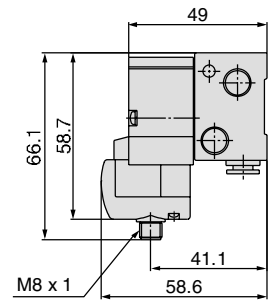
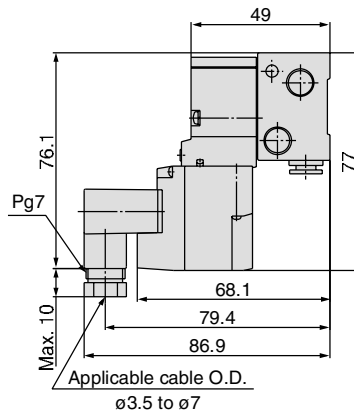
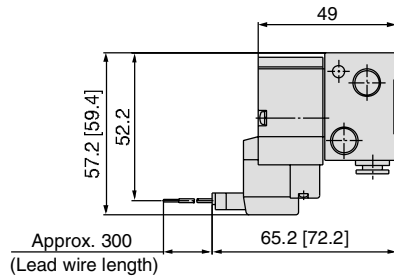
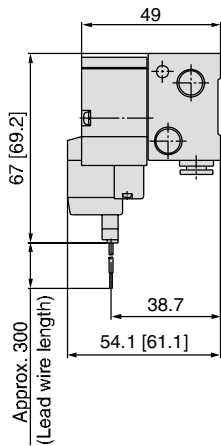

* Refer to page 1429 for dimensions with connector cable.

Port size	Station n	Station 2	3	4	5	6	7	8	9	10	11	12	13	14	15	16	17	18	19	Station 20
One-touch fitting	L1	50	66	82	98	114	130	146	162	178	194	210	226	242	258	274	290	306	322	338
	L2	41	57	73	89	105	121	137	153	169	185	201	217	233	249	265	281	297	313	329

Series SYJ500

Type 41 Manifold: Side Ported/SS3YJ5-41- Stations -M5, 01 □

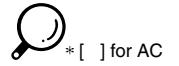

Grommet (G) For M5

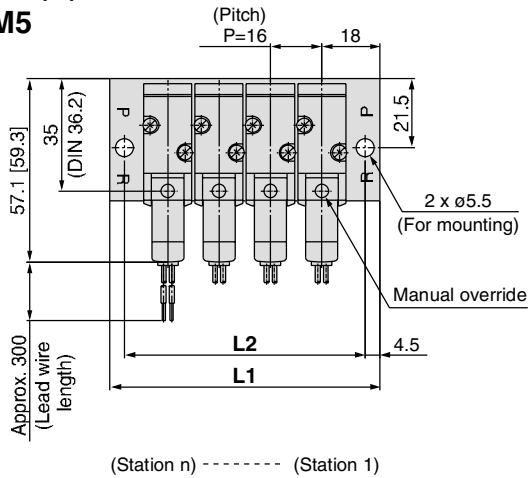

For 1/8

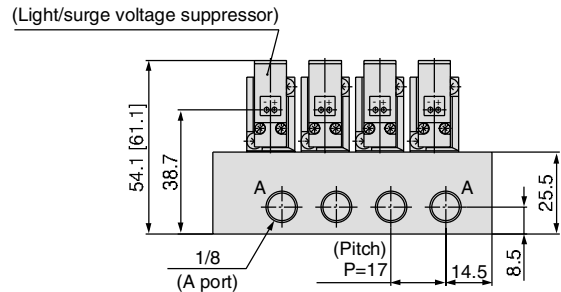
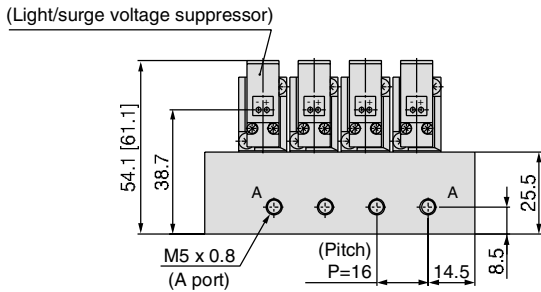
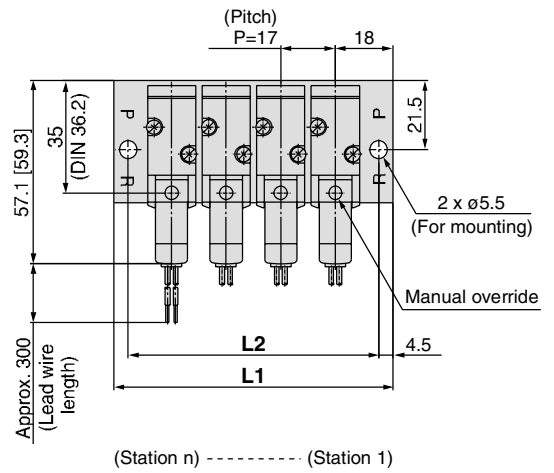

Port size	Station n	Station 2	3	4	5	6	7	8	9	10	11	12	13	14	15	16	17	18	19	Station 20
M5	L1	52	68	84	100	116	132	148	164	180	196	212	228	244	260	276	292	308	324	340
	L2	43	59	75	91	107	123	139	155	171	187	203	219	235	251	267	283	299	315	331
1/8	L1	53	70	87	104	121	138	155	172	189	206	223	240	257	274	291	308	325	342	359
	L2	44	61	78	95	112	129	146	163	180	197	214	231	248	265	282	299	316	333	350

Type 21R Manifold: Top Ported (External Pilot Type)/SS3YJ5-21R-**Stations**-00□

* [] for AC

Grommet (G)

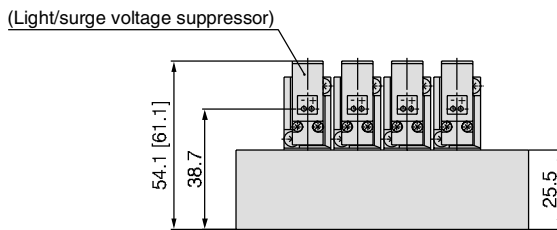
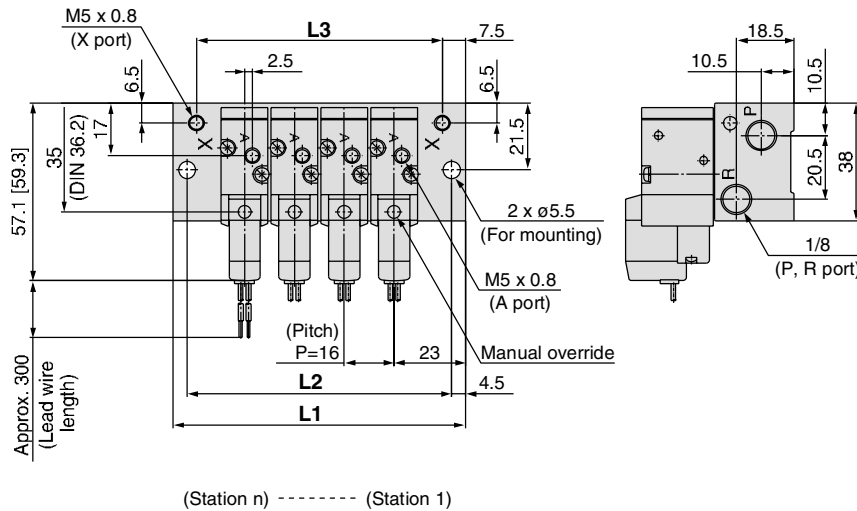

L plug connector (L)

M plug connector (M)

DIN terminal (D, Y)

M8 connector (WO)

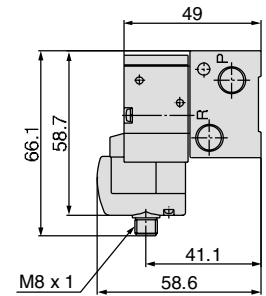
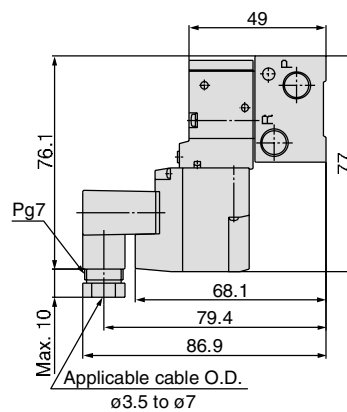
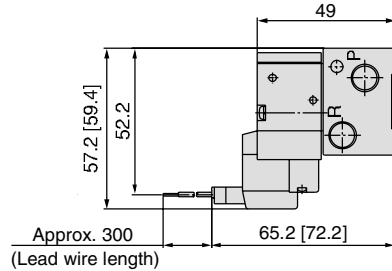
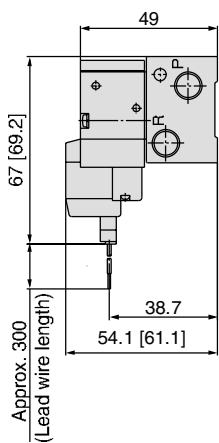

* Refer to page 1429 for dimensions with connector cable.

Station n	Station 2	3	4	5	6	7	8	9	10	11	12	13	14	15	16	17	18	19	Station 20
L1	62	78	94	110	126	142	158	174	190	206	222	238	254	270	286	302	318	334	350
L2	53	69	85	101	117	133	149	165	181	197	213	229	245	261	277	293	309	325	341
L3	47	63	79	95	111	127	143	159	175	191	207	223	239	255	271	287	303	319	335

Series SYJ500

Type 40R Manifold: Bottom Ported (External Pilot Type)/SS3YJ5-40R- Stations -M5, 01□

* [] for AC

Grommet (G)

For 1/8

For M5

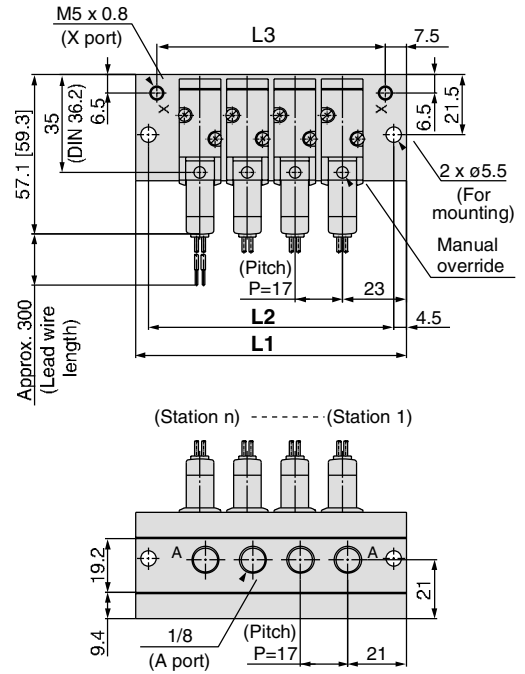
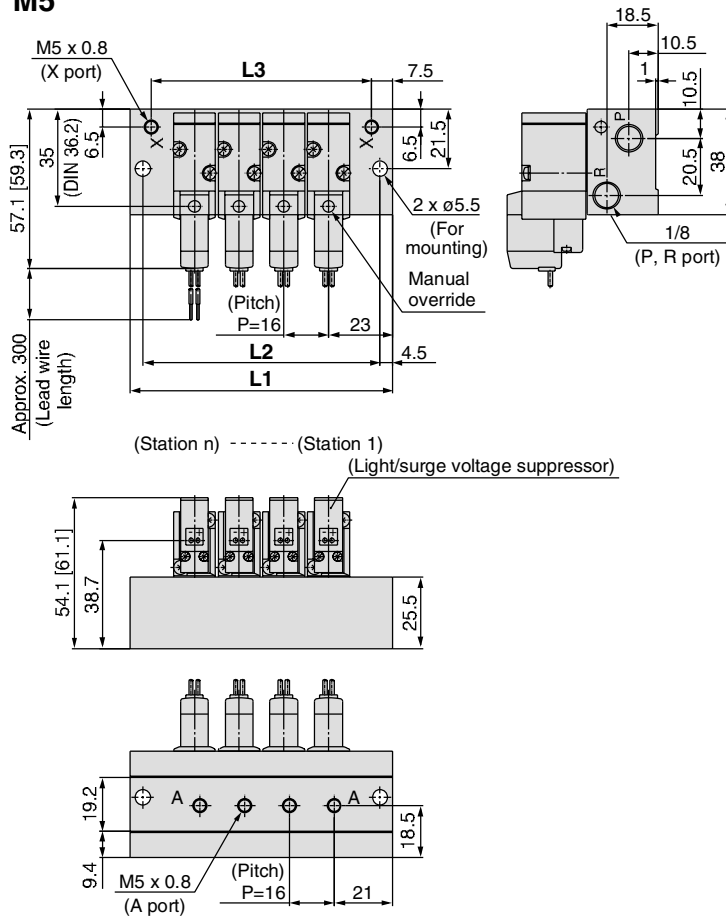

L plug connector (L)

M plug connector (M)

DIN terminal (D, Y)

M8 connector (WO)

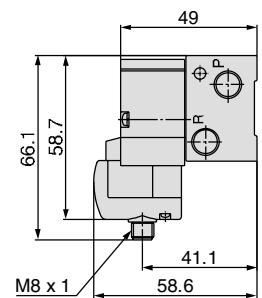
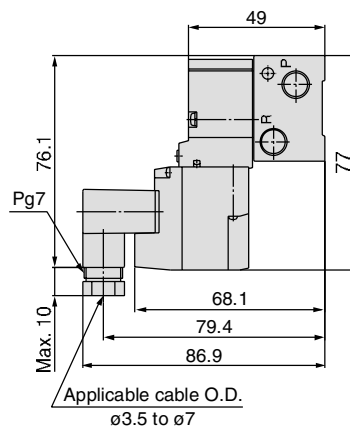
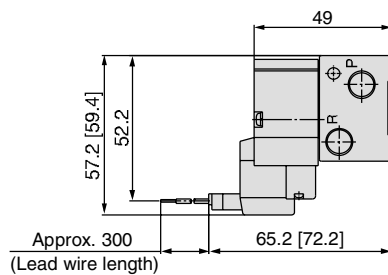
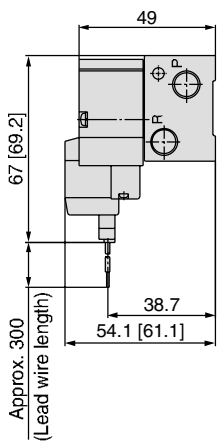

* Refer to page 1429 for dimensions with connector cable.

Port size	Station n	Station 2	3	4	5	6	7	8	9	10	11	12	13	14	15	16	17	18	19	Station 20
M5	L1	62	78	94	110	126	142	158	174	190	206	222	238	254	270	286	302	318	334	350
	L2	53	69	85	101	117	133	149	165	181	197	213	229	245	261	277	293	309	325	341
	L3	47	63	79	95	111	127	143	159	175	191	207	223	239	255	271	287	303	319	335
1/8	L1	63	80	97	114	131	148	165	182	199	216	233	250	267	284	301	318	335	352	369
	L2	54	71	88	105	122	139	156	173	190	207	224	241	258	275	292	309	326	343	360
	L3	48	65	82	99	116	133	150	167	184	201	218	235	252	269	286	303	320	337	354

Type 41R Manifold: Side Ported (External Pilot Type)/SS3YJ5-41R- **Stations** - C4, N3 C6, N7

* [] for AC

Grommet (G)

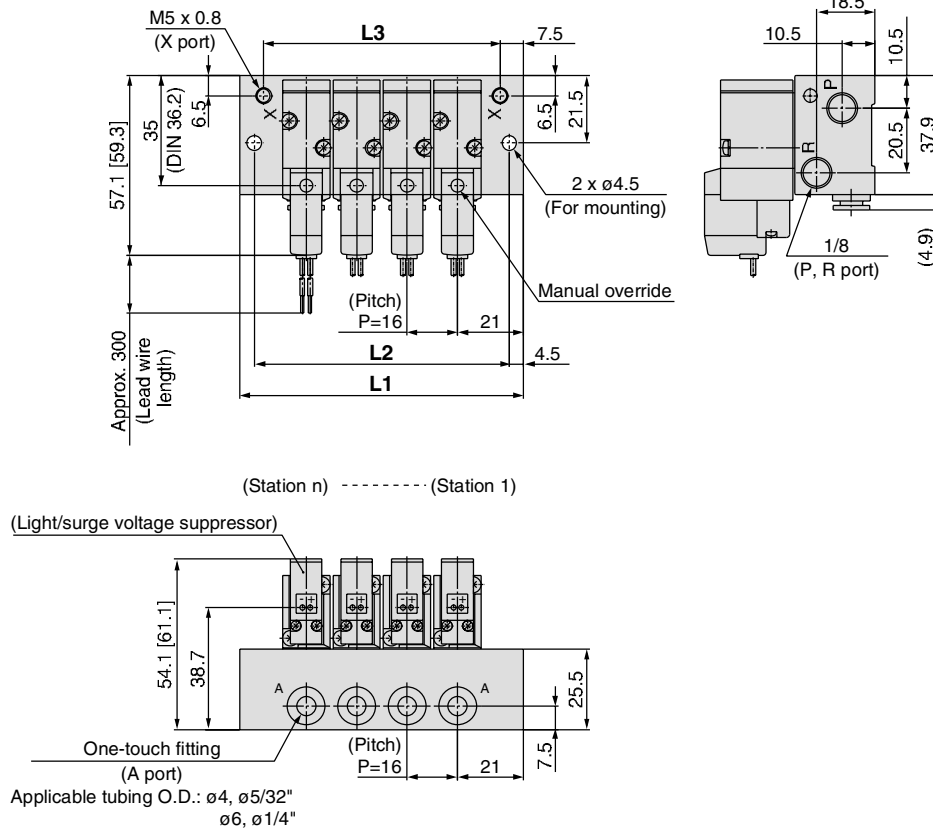

L plug connector (L)

M plug connector (M)

DIN terminal (D, Y)

M8 connector (WO)

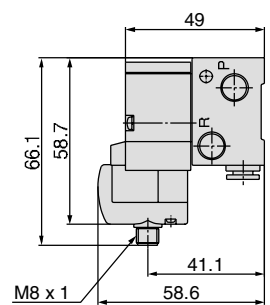
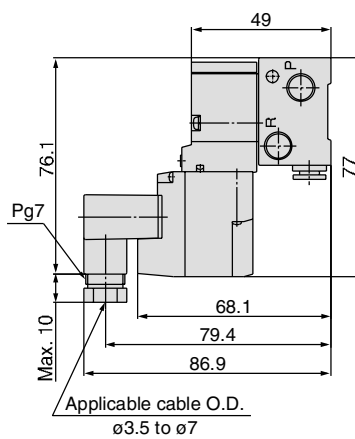
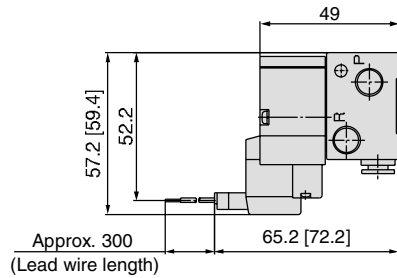
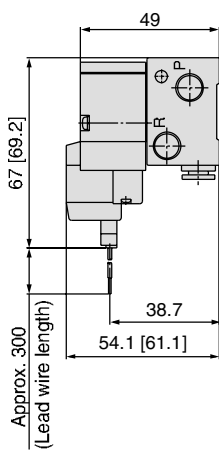

* Refer to page 1429 for dimensions with connector cable.

Port size	Station n	Station 2	3	4	5	6	7	8	9	10	11	12	13	14	15	16	17	18	19	Station 20
One-touch fitting	L1	58	74	90	106	122	138	154	170	186	202	218	234	250	266	282	298	314	330	346
	L2	49	65	81	97	113	129	145	161	177	193	209	225	241	257	273	289	305	321	337
	L3	43	59	75	91	107	123	139	155	171	187	203	219	235	251	267	283	299	315	331

Series SYJ500

Type 41R Manifold: Side Ported (External Pilot Type)/SS3YJ5-41R- Stations -M5, 01□

* [] for AC

For M5

For 1/8

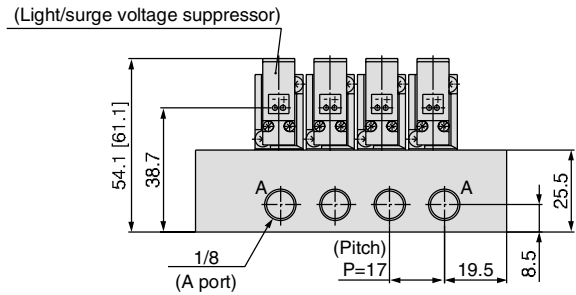
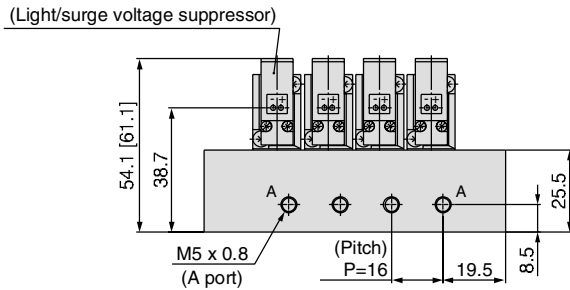
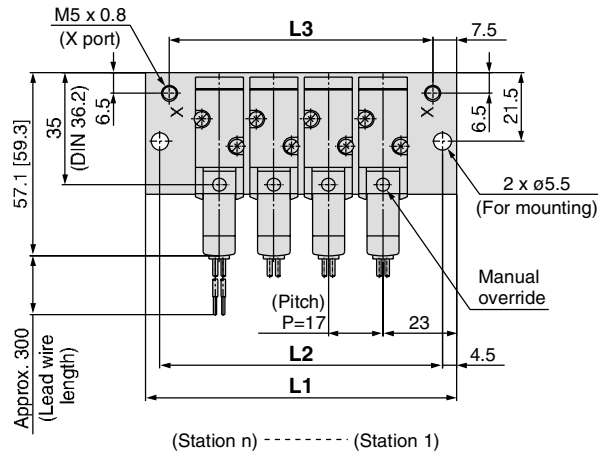
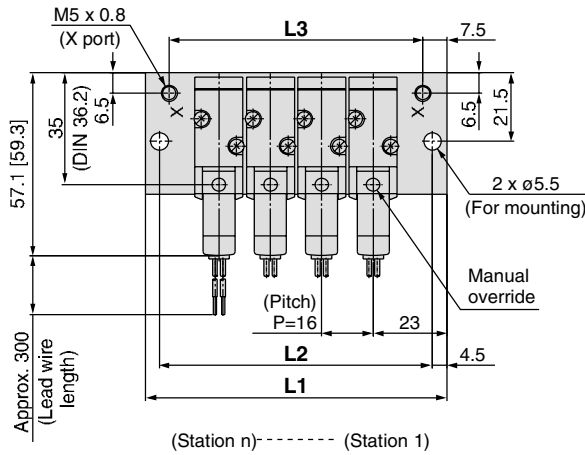

Port size	Station n	Station 2	3	4	5	6	7	8	9	10	11	12	13	14	15	16	17	18	19	Station 20
M5	L1	62	78	94	110	126	142	158	174	190	206	222	238	254	270	286	302	318	334	350
	L2	53	69	85	101	117	133	149	165	181	197	213	229	245	261	277	293	309	325	341
	L3	47	63	79	95	111	127	143	159	175	191	207	223	239	255	271	287	303	319	335
1/8	L1	63	80	97	114	131	148	165	182	199	216	233	250	267	284	301	318	335	352	369
	L2	54	71	88	105	122	139	156	173	190	207	224	241	258	275	292	309	326	343	360
	L3	48	65	82	99	116	133	150	167	184	201	218	235	252	269	286	303	320	337	354