

Nozzle Type Ionizer



Slim 16 mm ^{Thickness} x 100 mm ^{Width} x 46 mm ^{Height}

Lightweight 33% reduction
120 g → 80 g

Offset voltage: ±10 v
(For the energy saving nozzle)

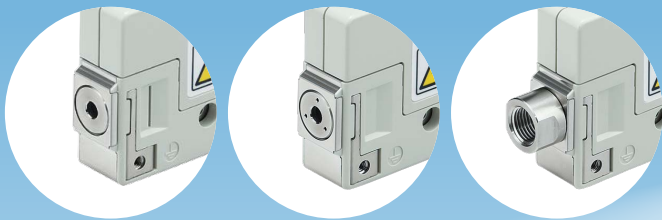

Energy saving nozzle

High flow rate nozzle

Female threads for piping



Nozzle Variations Made to order

With right angles -X367

pp. 4, 21

Energy saving nozzle



High flow rate nozzle



pp. 5, 23

Circular diffusion nozzle



Flat diffusion nozzle



Bar nozzle (Straight type)

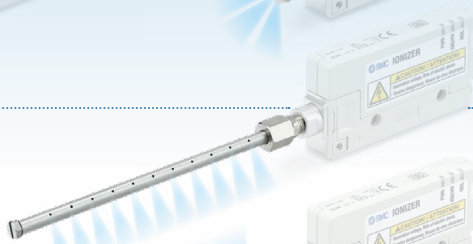

Circumferential jet bar nozzle (Straight type)

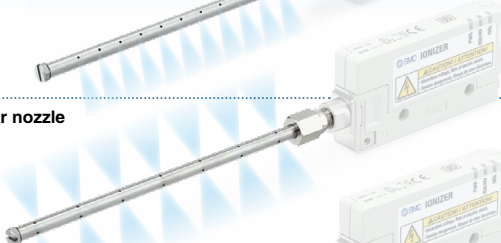

Bender tube nozzle

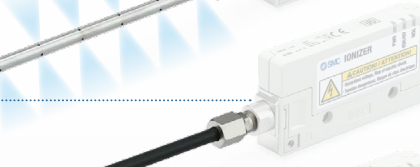

Long nozzle

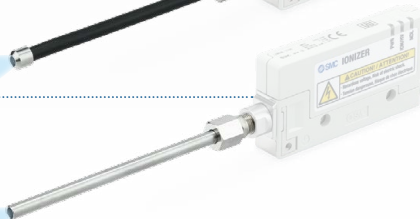

Application Examples

For dust removal and static neutralization by air blow

For plastic bottle static neutralization and particle elimination

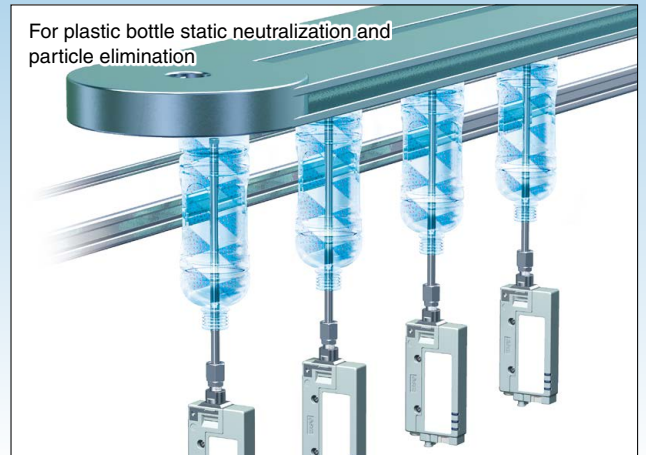

For spot type static neutralization

- Prevents the electrostatic breakdown of electric parts
- Prevents detachment failure

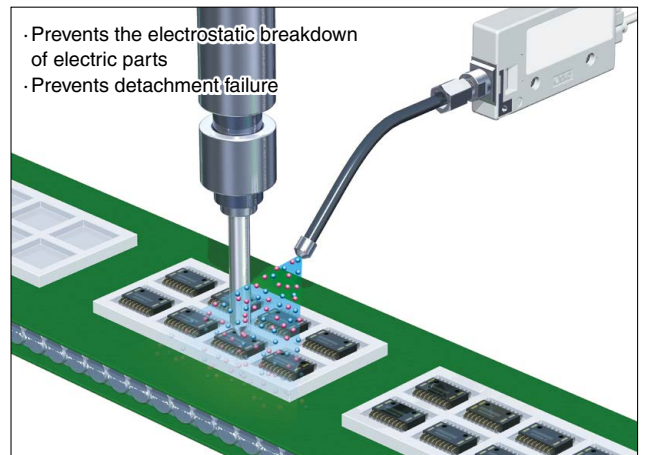

IZN10E Series



CAT.ES100-121B

The nozzle type can be selected according to the application.

Short range static neutralization

Energy saving nozzle

Designed with a focus on the offset voltage

Offset voltage: ± 10 V

Discharge time reduced by 65%

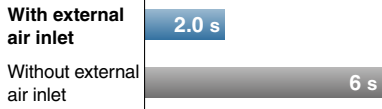

Ionized air flow velocity improved by 2.5 times or more



<Static neutralization is possible with minimal air consumption.>

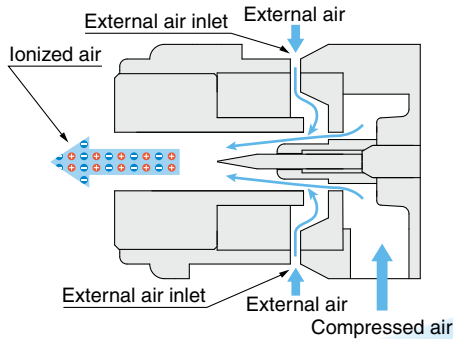

Conditions Supply pressure: 0.3 MPa, Distance: 300 mm, Air consumption flow rate: 10 L/min (ANR)

■ For the static neutralization of electric substrates

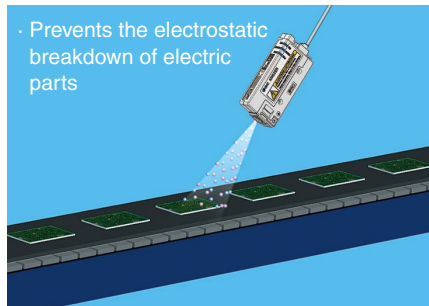

■ For the static neutralization of lenses

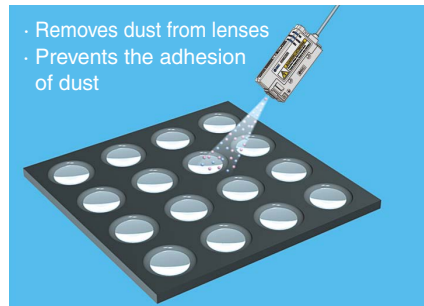

■ For the static neutralization of packing films

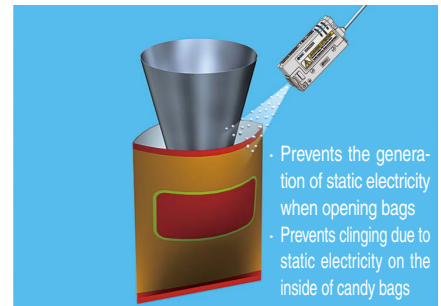

Long range static neutralization

High flow rate nozzle

- Improved dust removal performance
- Long range static neutralization: Max. 500 mm
- Offset voltage: ± 15 V

<The ionized air is assisted by the compressed air.>

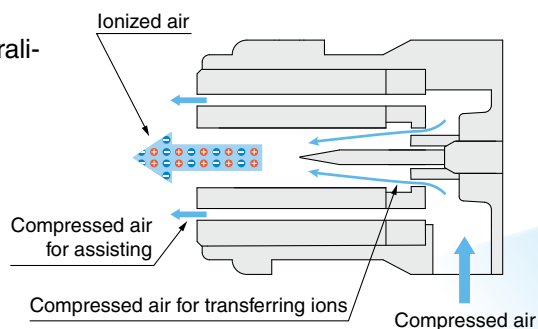

■ For the static neutralization of molded goods

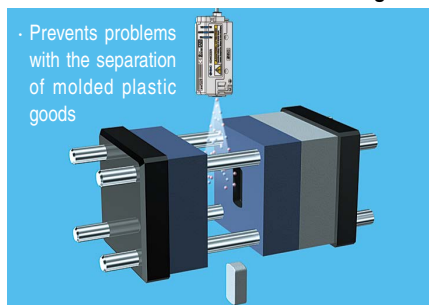

■ For the static neutralization of plastic cups



■ For the static neutralization of parts feeders

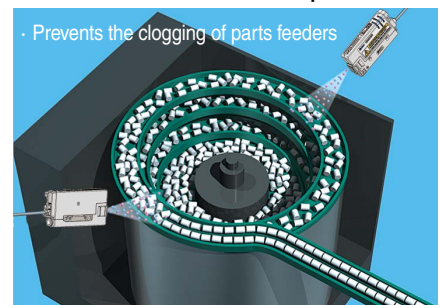

With external switch input function (2 inputs)

Prevents static neutralization problems

Discharge stops when abnormal purge air pressure is detected by the pressure switch.

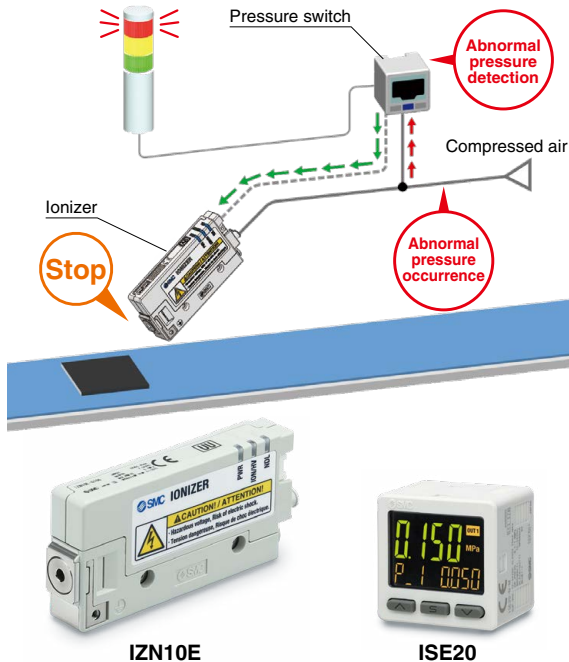

Energy saving

Discharge stops when the electrostatic sensor detects that static neutralization has been completed.

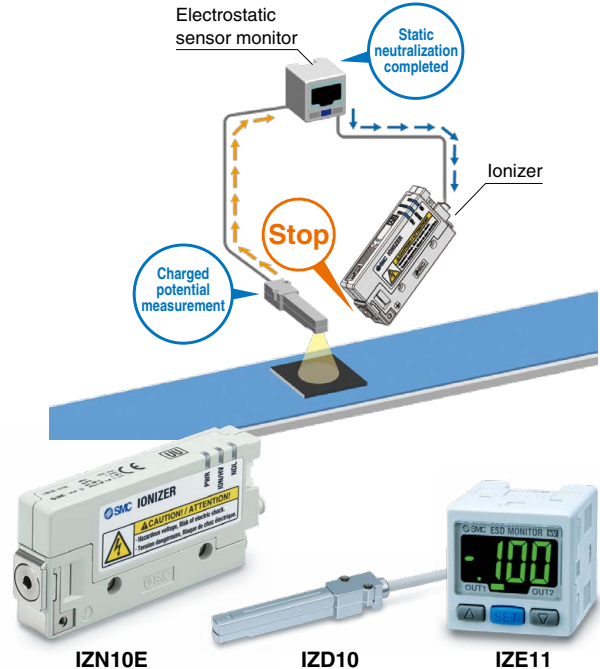

A high voltage power supply cable is not required.

A high voltage power supply is built in to the product; therefore, an external high voltage power supply or high voltage power supply cable is not required.

Easy maintenance

- **Can be disassembled into 3 parts**
Tools are not required for the installation or removal of the assembly.
- **It is possible to conduct maintenance on the emitter without removing the body.**
- **There is no need to readjust the nozzle angle when the ionizer is restarted.**

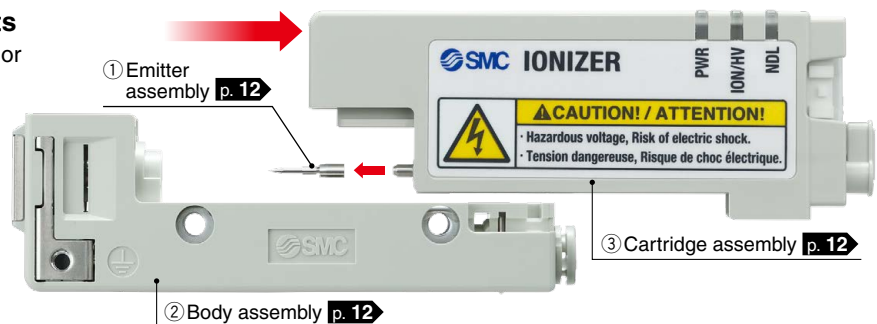

Maintenance warning function

- Monitors emitter contamination and wear continuously
- Notification of abnormalities via LED and output signal
- Detects optimal maintenance time
- Reduced maintenance labor

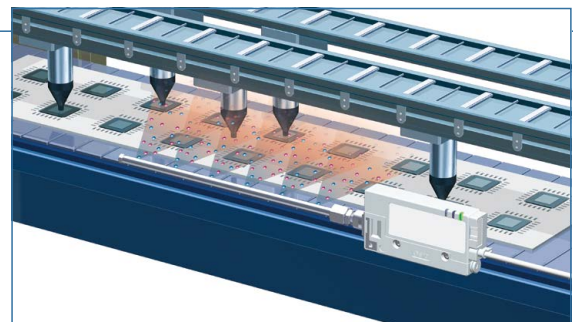

Mounting variations

● **Direct mounting**

Top through-hole mounting

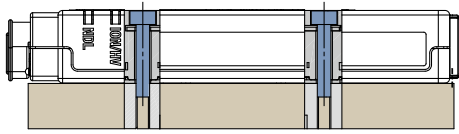

Bottom tapped mounting

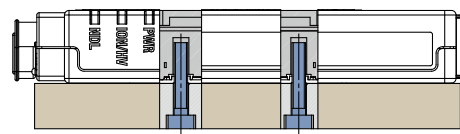

● **Bracket mounting** p. 12

L-bracket

(Mounting angle adjustable range)

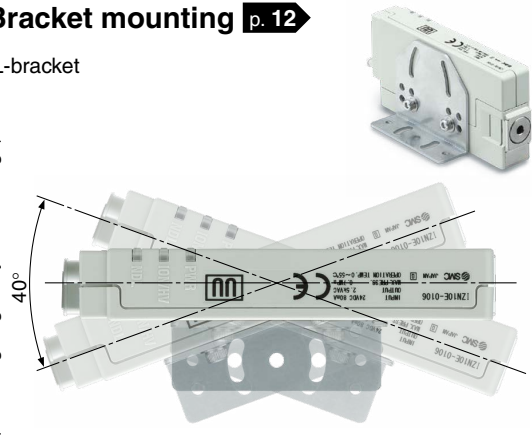

Pivoting bracket

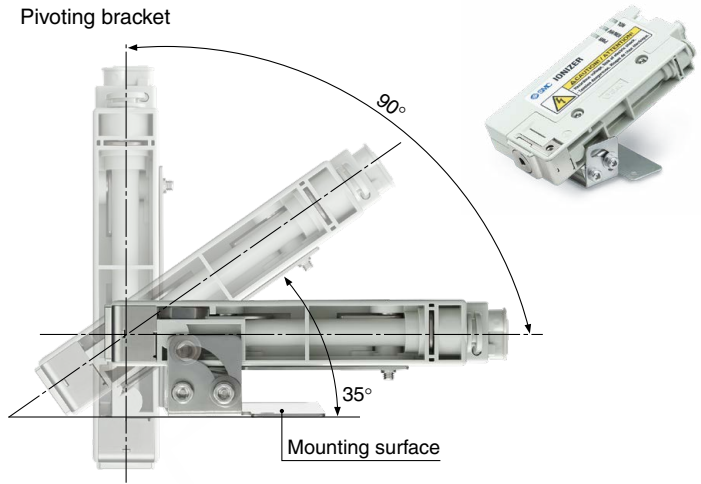

DIN rail mounting bracket

30°

(Mounting angle adjustable range)

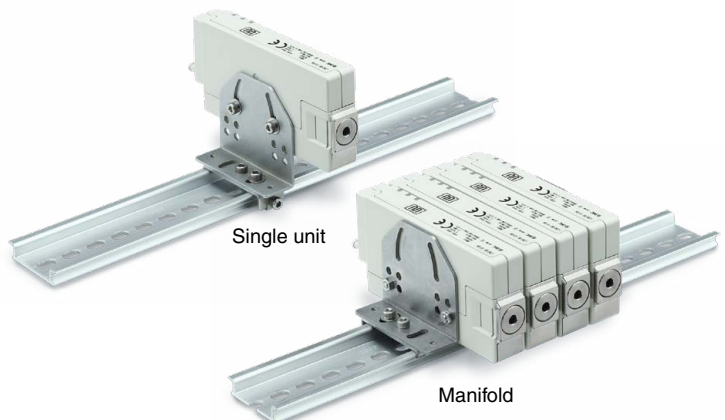
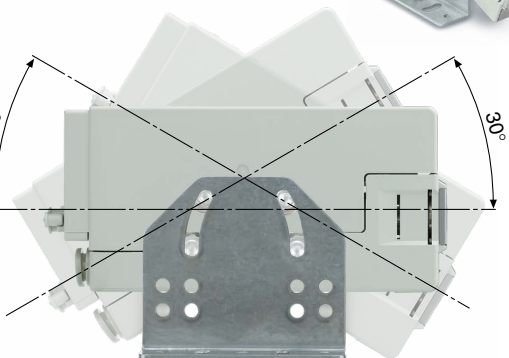

· The L-bracket and the DIN rail mounting bracket can be used with the manifold.

Intermittent control timer Related product p. 20

Air saving
IZE110-X238

A digital timer that can control the ON/OFF switches of valves, etc.

Intermittent ion discharge reduces air consumption.

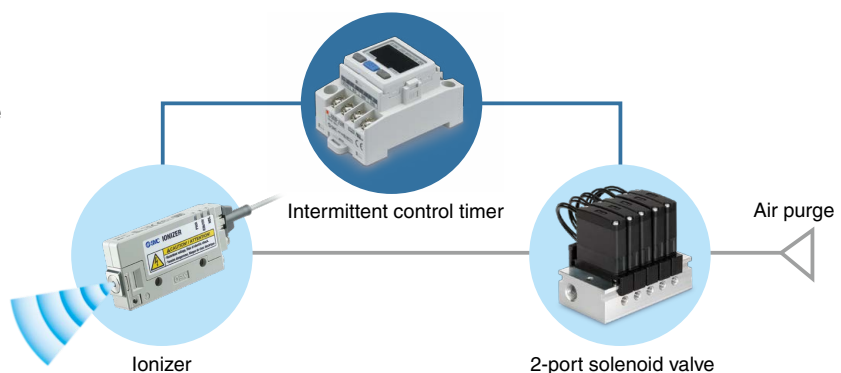

Nozzle variations Made to order p. 21

With right angles -X367

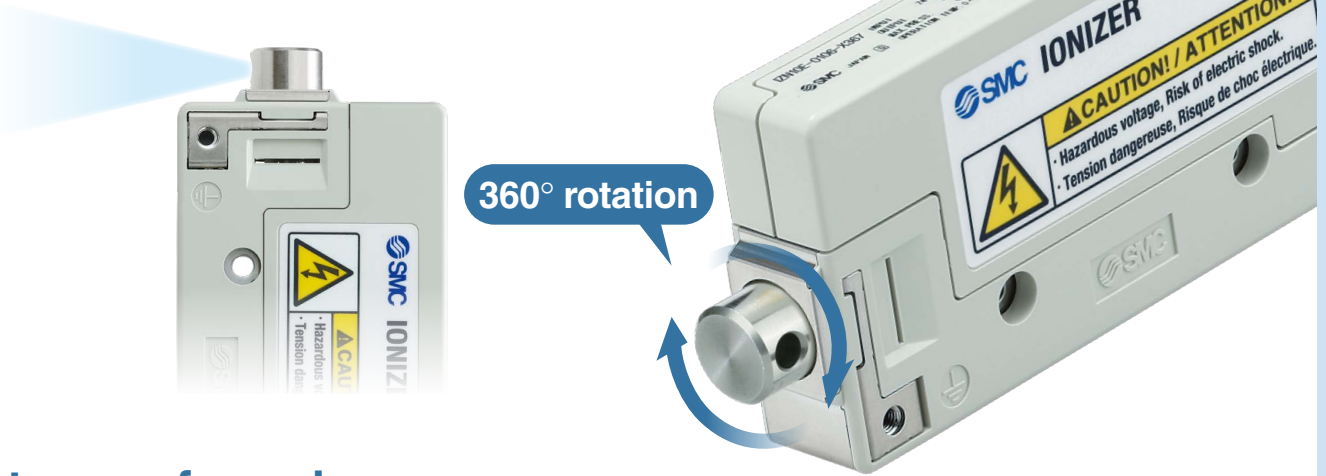

2 types of nozzles

*1 Installation distance: 100 mm

Energy saving nozzle

Short range static neutralization
 Designed with a focus on the offset voltage

Offset voltage: Within $\pm 10\text{ V}^{*1}$
 Increases air blow flow rate by external air intake

Static neutralization is possible with minimal air consumption.

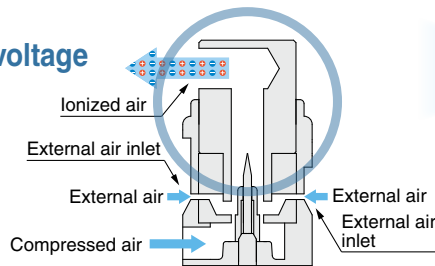

High flow rate nozzle

Long range static neutralization and dust removal

The ionized air is assisted by the compressed air.

- Dust removal performance can be improved by using the energy of the compressed air.
- Suitable for static neutralization at a long distance (max. 500 mm)

Offset voltage: Within $\pm 30\text{ V}^{*1}$

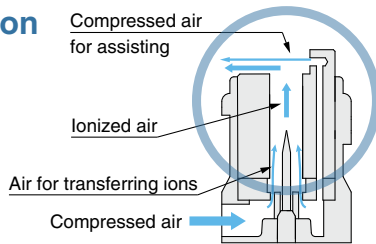

■ Static neutralization in narrow spaces is possible.

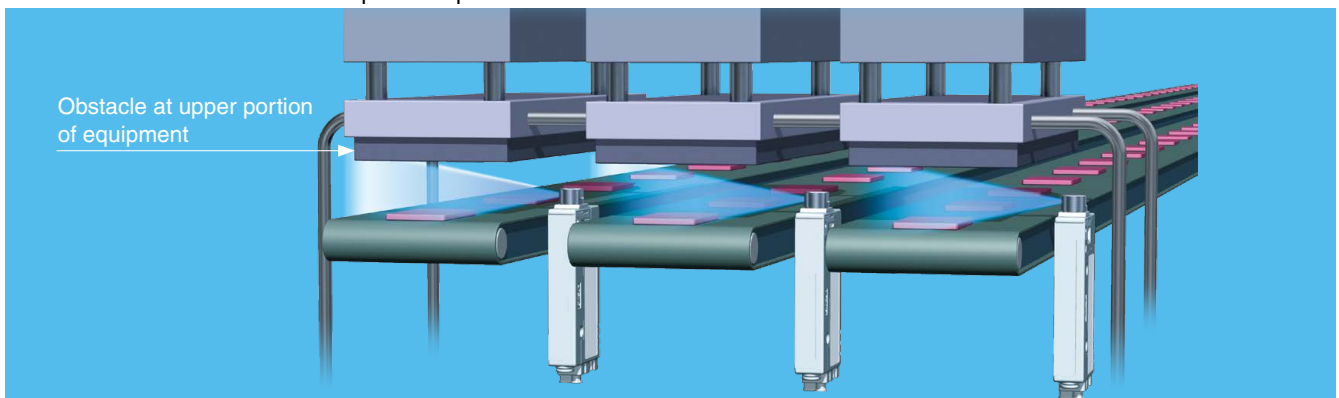

Nozzle variations Made to order **p. 23**

Circular diffusion nozzle

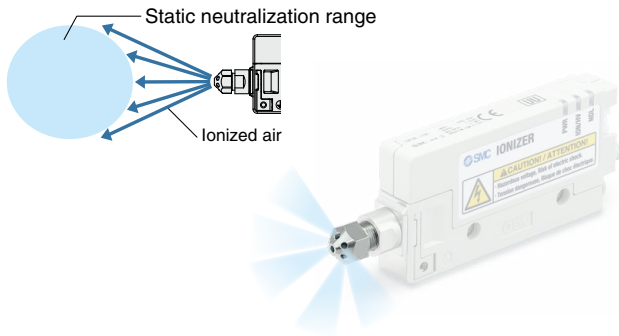

Flat diffusion nozzle

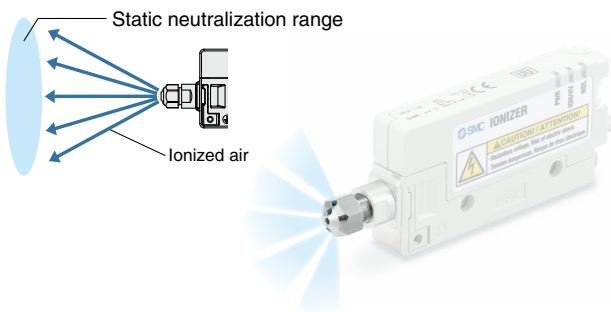

Bar nozzle (Straight type)

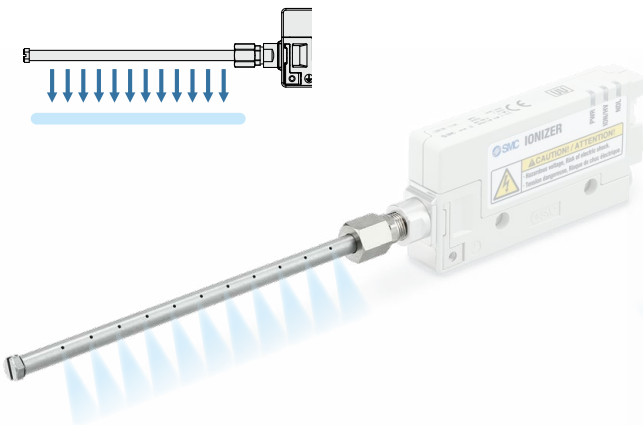

Circumferential jet bar nozzle (Straight type)

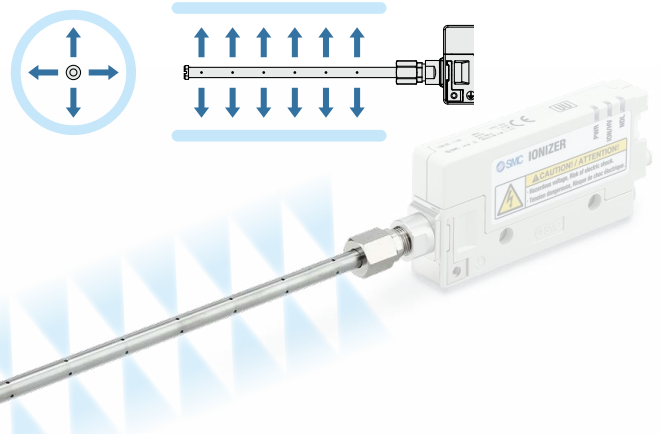

Bender tube nozzle

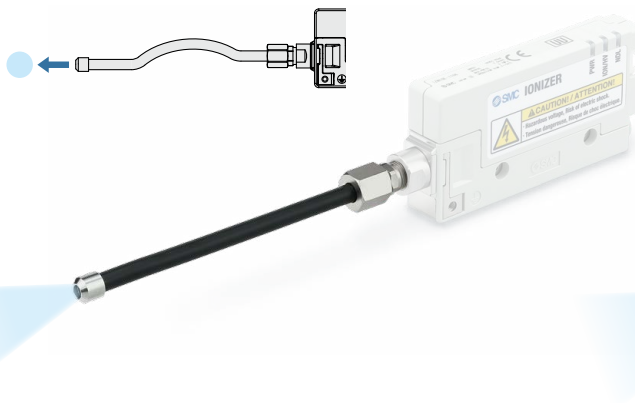



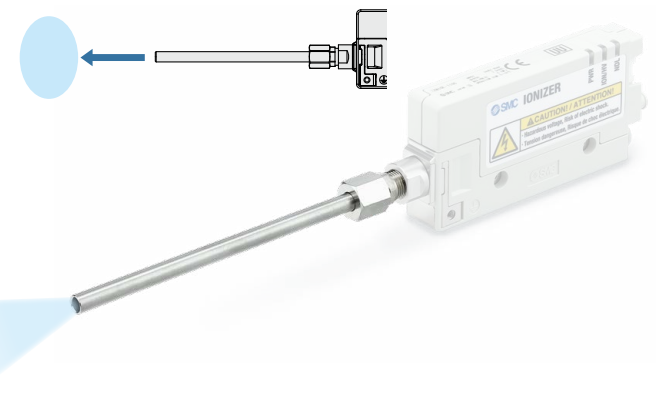











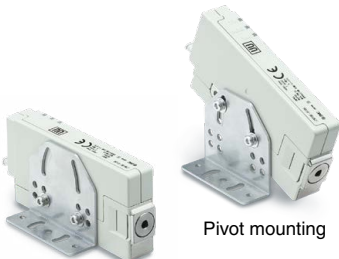



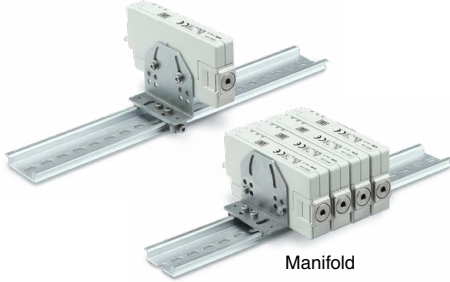





Long nozzle



For the ionizer, please select the female threads for piping (Rc1/8).

Series Variations

	IZN10E-01 	IZN10E-02 	IZN10E-11 	
Nozzle type	Energy saving nozzle 	High flow rate nozzle 	Female threads for piping 	
Ion generation method	Corona discharge type			
Input/Output specifications	NPN, PNP			
Bracket p. 12	L-bracket  Fixed mounting  Pivot mounting 	Pivoting bracket 	DIN rail mounting bracket  Manifold 	
Options p. 13	Manifold mounting parts set 	AC adapter 	Cleaning kit 	
Related product Made to order p. 20	Related product Intermittent control timer 	Made to order Nozzle variations <div style="display: flex; flex-wrap: wrap;"> <div style="width: 50%;"> Energy saving nozzle with right angles  </div> <div style="width: 50%;"> High flow rate nozzle with right angles  </div> <div style="width: 50%;"> Circular diffusion nozzle  </div> <div style="width: 50%;"> Flat diffusion nozzle  </div> <div style="width: 50%;"> Bar nozzle (Straight type)  </div> <div style="width: 50%;"> Circumferential jet bar nozzle (Straight type)  </div> <div style="width: 50%;"> Bender tube nozzle  </div> <div style="width: 50%;"> Long nozzle  </div> </div>		

CONTENTS

Nozzle Type Ionizer *IZN10E Series*



Energy saving nozzle



High flow rate nozzle



Female threads for piping

Technical Data

Static Neutralization Characteristics

- ① Installation Distance and Discharge Time p. 8
- ② Static Neutralization Range p. 8
- ③ Pressure — Flow Rate Characteristics p. 9

Ozone Concentration p. 9

How to Order p. 10

Specifications p. 11

Accessories p. 12

Repair Parts p. 12

Options p. 13

Functions p. 14

Wiring p. 15

Power Supply Cable Connection Circuit p. 16

Timing Chart p. 16

Dimensions p. 17

Related Product

Intermittent Control Timer p. 20

Made to Order

With right angles -X367 p. 21

Nozzle Variations p. 23

Specific Product Precautions p. 24

Safety Instructions Back cover

IZN10E Series

Technical Data

* Static neutralization characteristics are based on data using a charged plate (dimensions: 150 mm x 150 mm, capacitance: 20 pF) as defined in the U.S. ANSI standards (ANSI/ESD STM3.1-2006). Use this data only as a guideline for model selection because the values vary depending on the material and/or size of the subject.

Static Neutralization Characteristics

① Installation Distance and Discharge Time (Discharge Time from +1000 V to +100 V)

Energy saving nozzle / IZN10E-01

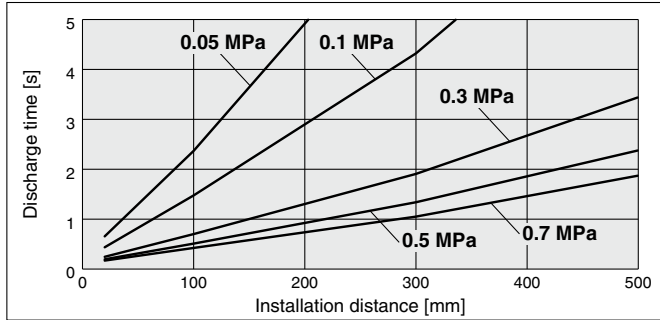

High flow rate nozzle / IZN10E-02

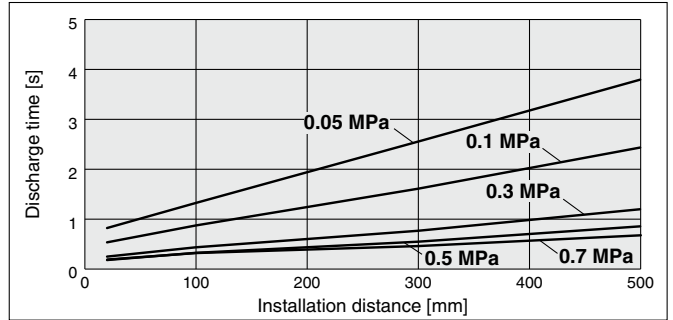

Female threads for piping / IZN10E-11 With Stainless steel 316 One-touch fitting*2 + Anti-static tubing

* Discharge time at a distance of 50 mm from the end of tube

Tube I.D.: 4 mm

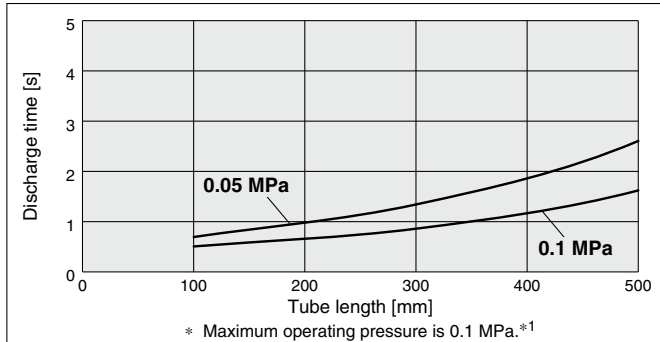

Tube I.D.: 5 mm

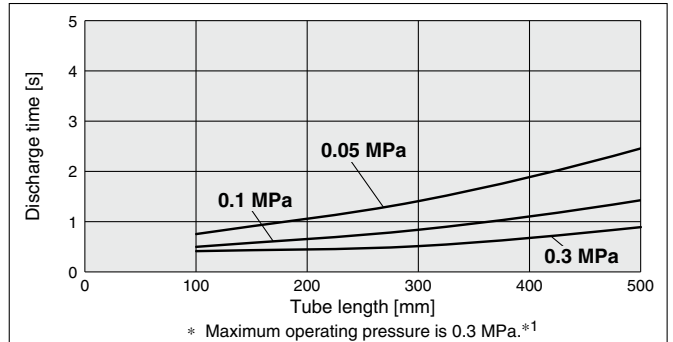

*1 Refer to "Cautions when using the IZN10E-11 female threads for piping" on page 10.

*2 The ionizer generates a small amount of ozone. Please use ozone resistant tubing and fittings for piping the female threads. Check periodically for ozone deterioration, and replace if necessary.

② Static Neutralization Range (Discharge Time from +1000 V to +100 V)

High flow rate nozzle / IZN10E-02

Supply pressure: 0.1 MPa, Flow rate 39 L/min (ANR)

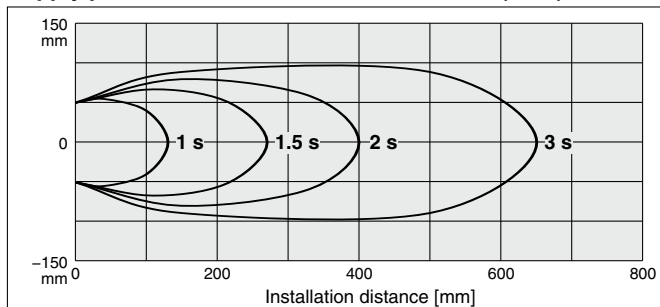

Supply pressure: 0.3 MPa, Flow rate 80 L/min (ANR)

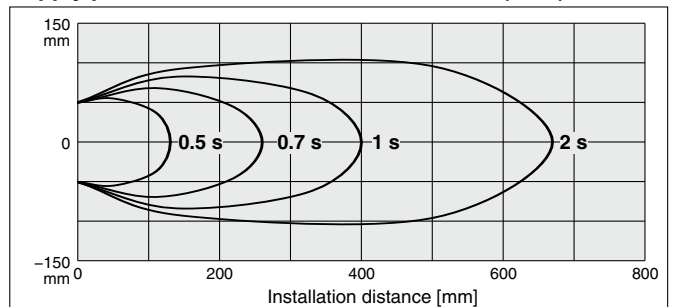

Supply pressure: 0.5 MPa, Flow rate 121 L/min (ANR)

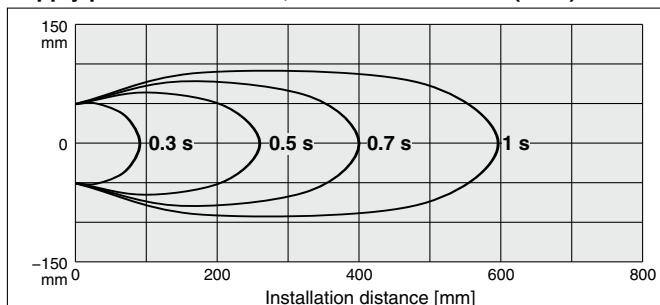

IZN10E Series

* Static neutralization characteristics are based on data using a charged plate (dimensions: 150 mm x 150 mm, capacitance: 20 pF) as defined in the U.S. ANSI standards (ANSI/ESD STM3.1-2006). Use this data only as a guideline for model selection because the values vary depending on the material and/or size of the subject.

Static Neutralization Characteristics

③ Pressure — Flow Rate Characteristics

Energy saving nozzle / IZN10E-01

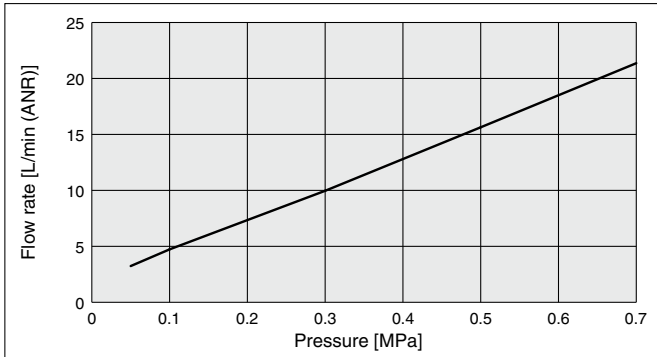

High flow rate nozzle / IZN10E-02

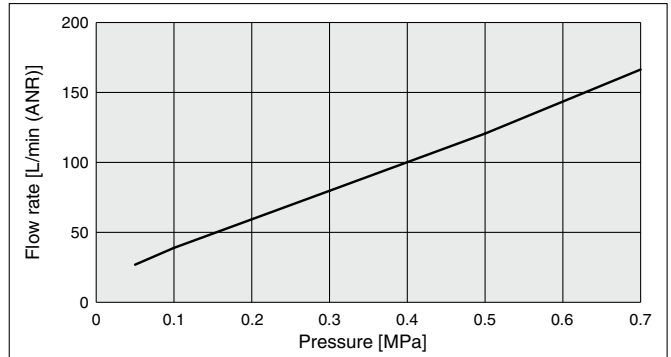

Female threads for piping / IZN10E-11 With Stainless steel 316 One-touch fitting + Anti-static tubing

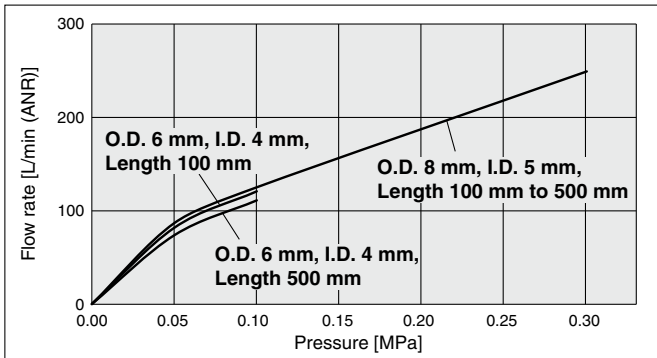

* When a pressure above each line is used, the maintenance warning function may work and turn on the LED. Refer to "Cautions when using the IZN10E-11 female threads for piping" on page 10.

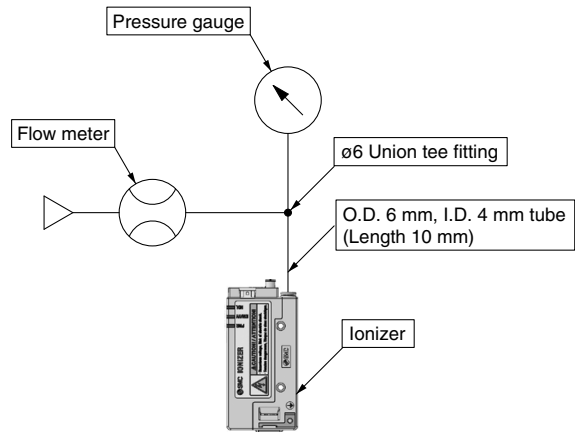
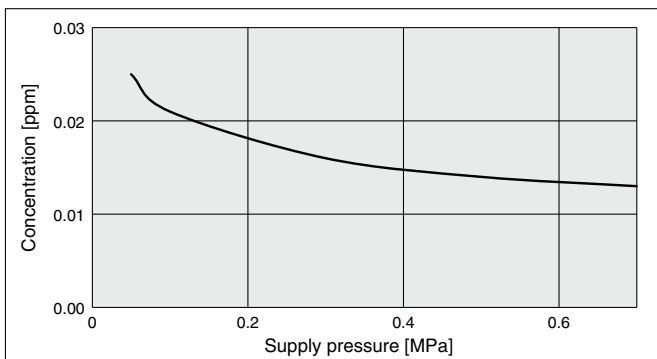

Fig. 1: Flow rate characteristics measuring circuit

Ozone Concentration

Energy saving nozzle / IZN10E-01



High flow rate nozzle / IZN10E-02

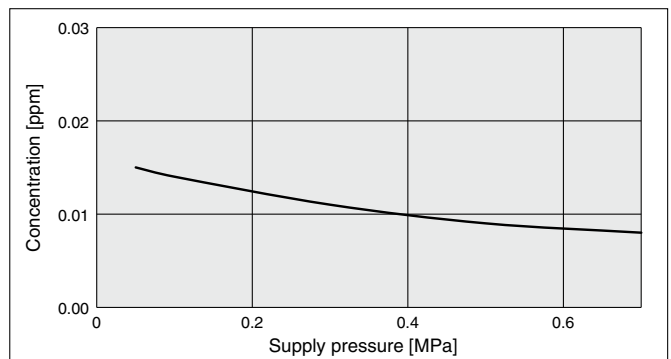

* Ozone condensation can increase in an enclosed space. Check the ozone condensation of the operating environment before use.

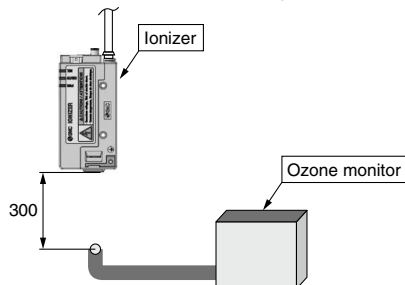
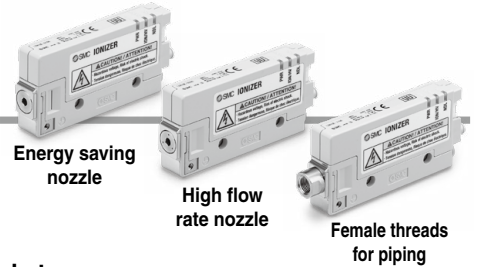

Fig. 2: Ozone condensation measuring circuit

Nozzle Type Ionizer IZN10E Series



How to Order



IZN10E - 01 P 06 Z - B1

High frequency AC nozzle model

Nozzle type

Symbol	Type
01	Energy saving nozzle
02	High flow rate nozzle
11	Female threads for piping*1

*1 Refer to the cautions when using the female threads for piping shown below.

Input/Output specifications

Symbol	Type
Nil	NPN input/output
P	PNP input/output

One-touch fitting

Symbol	Type
06	<div style="display: flex; align-items: center;"> <div style="margin-right: 10px;">ø6: Metric size</div> </div>
07	<div style="display: flex; align-items: center;"> <div style="margin-right: 10px;">ø6.35 (1/4"): Inch size</div> </div>
16	<div style="display: flex; align-items: center;"> <div style="margin-right: 10px;">ø6: Metric size (Elbow)</div> </div>
17	<div style="display: flex; align-items: center;"> <div style="margin-right: 10px;">ø6.35 (1/4"): Inch size (Elbow)</div> </div>

* The One-touch fitting cannot be changed after the delivery of the product.

Cautions when using the IZN10E-11 female threads for piping

- For the female thread (Rc1/8) type, a made-to-order nozzle or fittings/tubing combination must be prepared and connected by the user.
- If a nozzle with discharge port diameter or tubing with an I.D. of less than 4 mm is connected, the air pressure inside the nozzle may increase depending on the configuration.
- This product uses a high frequency AC voltage. If the air pressure around the emitter increases during ion generation, the ion generation efficiency decreases and the maintenance alarm (signal output, maintenance LED) will be activated. (Refer to the figure to the right.)
- When the maintenance alarm is generated, the static neutralization performance is decreased.
- The table below shows the supply pressure specifications when made-to-order nozzles and fittings/tubing combinations are connected.

Bracket

Symbol	Type	Part no.
Nil	Without bracket	—
B1	L-bracket	IZN10-B1
B2	Pivoting bracket	IZN10-B2
B3	DIN rail mounting bracket	IZN10-B3

* Refer to page 12. Brackets are the same as those for the previous model (IZN10). Mounting is interchangeable.

Power supply cable

Symbol	Type	Part no.
Nil	With power supply cable (3 m)	IZN10E-CP
Z	With power supply cable (10 m)	IZN10E-CPZ
N	Without power supply cable	—

* Mounting is interchangeable with the previous model (IZN10).



Made to Order
(For details, refer to page 21.)

Symbol	Specifications
-X367	Nozzle with right angles

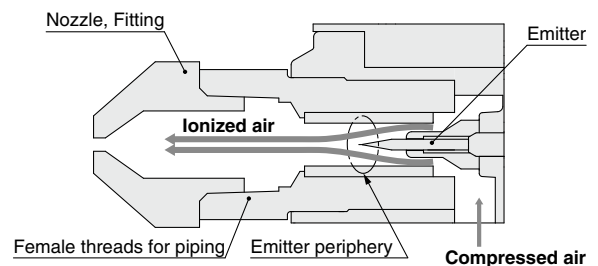

Sectional view of the female threads for piping

Made-to-order nozzle product names / Piping examples	Made-to-order nozzle part no. (Page 23)	Supply pressure specifications
Circular diffusion nozzle	IZN10-G-X198	0.05 to 0.1 MPa
Flat diffusion nozzle	IZN10-G-X199	0.05 to 0.1 MPa
Bar nozzle (Straight type)	IZN10-G-□-X216	0.05 to 0.1 MPa
Circumferential jet bar nozzle (Straight type)	IZN10-G-X278	0.05 to 0.15 MPa
Bender tube nozzle	IZN10-G-□-X205	0.05 to 0.15 MPa
Long nozzle	IZN10-G-□-X226	0.05 to 0.15 MPa
Fitting (Applicable tubing O.D. 6 mm) + Tube (O.D. 6 mm, I.D. 4 mm)*1	—	0.05 to 0.1 MPa
Fitting (Applicable tubing O.D. 8 mm) + Tube (O.D. 8 mm, I.D. 5 mm)*1	—	0.05 to 0.3 MPa

*1 When connecting the tubing, use a length of tubing 500 mm or less for the connection, regardless of the inside diameter size.

- When using piping materials prepared by the user, secure an air passage of 4 mm or more inside diameter. If using tubing, ensure the minimum bending radius is used and keep the tube length to 500 mm or less.
- Please install so as not to receive a moment force on the nozzle. (Refer to page 25.)

IZN10E Series

Specifications

Model		IZN10E-□ (NPN specification)	IZN10E-□P (PNP specification)
Ion generation method		Corona discharge type	
Method of applying voltage		High frequency AC type	
Applied voltage*1		2.5 kVAC	
Offset voltage (Ion balance)*2	Energy saving nozzle	±10 V	
	High flow rate nozzle	±15 V	
Air purge	Fluid	Air (Clean dry air)	
	Operating pressure*3*4	0.05 MPa to 0.7 MPa	
	Connecting tube size	ø6, ø1/4"	
Power supply voltage		24 VDC ±10%	
Current consumption		80 mA or less	
Input signal	Discharge stop signal	Connected to 0 V Voltage range: 5 VDC or less Current consumption: 5 mA or less	Connected to +24 V Voltage range: 19 VDC to power supply voltage Current consumption: 5 mA or less
	Reset signal		
	External switch signal 1		
	External switch signal 2		
Output signal	Discharge signal	Max. load current: 40 mA Residual voltage: 1 V or less (Load current at 40 mA) Max. applied voltage: 26.4 VDC	Max. load current: 40 mA Residual voltage: 1 V or less (Load current at 40 mA)
	Error signal		
	Maintenance signal		
Effective static neutralization range*5		20 to 500 mm	
Ambient temperature (Operating/Stored)		0 to 55°C	
Ambient humidity (Operating/Stored)		35 to 65% RH (No condensation)	
Material	Housing	ABS, Stainless steel	
	Nozzle	Stainless steel	
	Emitter	Tungsten	
Impact resistance		100 m/s ²	
Body weight	Energy saving nozzle	70 g	
	High flow rate nozzle	70 g	
	Female threads for piping	75 g	
Bracket weight	L-bracket	30 g	
	Pivoting bracket	40 g	
	DIN rail mounting bracket (Single unit)	40 g	
Standards/Directive		CE, UL, CSA, RoHS	

*1 Measured with a probe of 1000 MΩ and 5 pF

*2 Measurement values based on a charged plate (dimensions: 150 mm x 150 mm, capacitance: 20 pF) defined by ANSI standard (ANSI/ESD STM3.1-2015). The distance between the charged plate and the ionizer: 100 mm, the air purge is 0.3 MPa (energy saving nozzle) / 0.1 MPa (high flow rate nozzle).

*3 Static electricity cannot be neutralized without air purge. As the concentration of ozone inside the nozzle increases, there is a possibility that the product and surrounding equipment may be adversely affected, so air has to be purged during ion generation.

*4 To stop the air purge temporarily during operation, turn the discharge stop signal input OFF to prevent the increase of ozone concentration inside the nozzle.

*5 Except female threads for piping

* Refer to the cautions on page 10 when using the IZN10E-11 (female threads for piping).

Model		IZN10E-C□-□
Input voltage*1		100 to 240 VAC, 50/60 Hz
Output voltage		24 VDC
Output current		1 A max
Ambient temperature	Operating	0 to 40°C
	Stored	-20 to 60°C
Ambient humidity	Operating/Stored	10 to 90% RH
Standards/Directive		CE, cUL

*1 For the AC cord type, note that the rated voltage of the AC cord included as an accessory is 125 V. (Refer to page 13.)

Accessories

Bracket

IZN10 - B1

• **Bracket**

Symbol	Type
B1	L-bracket
B2	Pivoting bracket
B3	DIN rail mounting bracket

L-bracket

IZN10-B1



Fixed mounting



Pivot mounting

Pivoting bracket

IZN10-B2



DIN rail mounting bracket

IZN10-B3

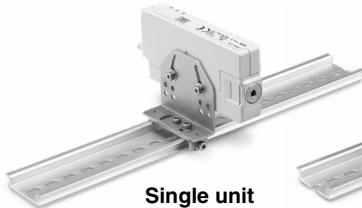

Single unit



Manifold*1

*1 The L-bracket and the DIN rail mounting bracket can be used with the manifold.

Power supply cable

IZN10E - CP

• **Power supply cable**

Symbol	Type
Nil	3 m
Z	10 m

Power supply cable: Made to order

IZN10E - CP 01 - X13

• **Power supply cable length**

Symbol	Type
01	1 m
:	:
20	20 m

* Available in 1 m increments from 1 m to 20 m. Use standard power supply cables for 3 m and 10 m lengths.



Repair Parts

Emitter assembly

IZN10E-NT

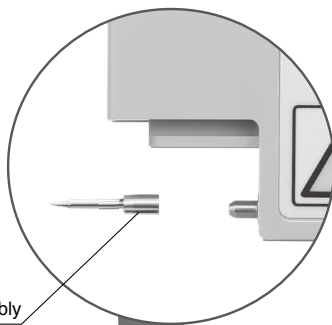

Emitter assembly



Body assembly

IZN10E - A002 - 01 06

• **Nozzle type**

Symbol	Type
01	Energy saving nozzle
02	High flow rate nozzle
11	Female threads for piping



• **One-touch fitting**

Symbol	Type
06	ø6: Metric size
07	ø6.35 (1/4"): Inch size
16	ø6: Metric size (Elbow)
17	ø6.35 (1/4"): Inch size (Elbow)

Cartridge assembly

IZN10E - A003 -

• **Input/Output specifications**

Symbol	Type
Nil	NPN input/output
P	PNP input/output



IZN10E Series

Options

Manifold mounting parts set

This set consists of a hexagon socket head cap screw, spacer, and hexagon nut.

*1 The ionizer, L-bracket, and DIN rail mounting bracket need to be prepared separately.

IZN10E-ES 4

Mounting pitch

Symbol	Pitch
ES	17.4 mm

Mounting stations

Symbol	Stations
2	2
3	3
4	4

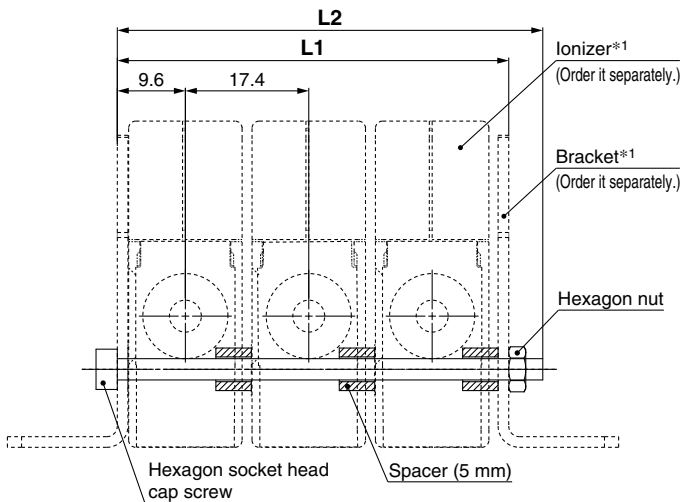
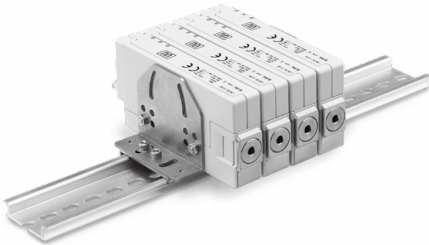

Part no.	L1	L2	Number of spacers
IZN10E-ES2	37.8	45	4
IZN10E-ES3	55.2	60	6
IZN10E-ES4	72.6	76	8

AC adapter

IZN10E-C G1 -

AC adapter

Symbol	Type
G1	With AC cord*1
G2	Without AC cord

Input/Output specifications*2

Symbol	Type
Nil	NPN input/output
P	PNP input/output

*1 AC cord is only for use in Japan. (Rated voltage 125 V, Plug JIS C8303, Inlet IEC60320-C8)

*2 Select the same input/output specification as the ionizer.

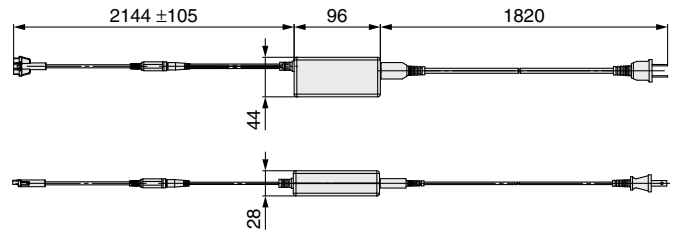

Cleaning kit IZS30-M2



Functions

1. Maintenance warning

Constantly monitors the emitter for lowered static neutralization performance due to the contamination or wear of the emitter. The maintenance LED lights up and the maintenance signal is generated when abnormalities are detected.

2. Signal inputs by external switch

There are 2 ports for external switch signal inputs.

Example Discharge stops when abnormal purge air pressure is detected by the pressure switch.

- Prevents static neutralization problems due to compressed air pressure drops

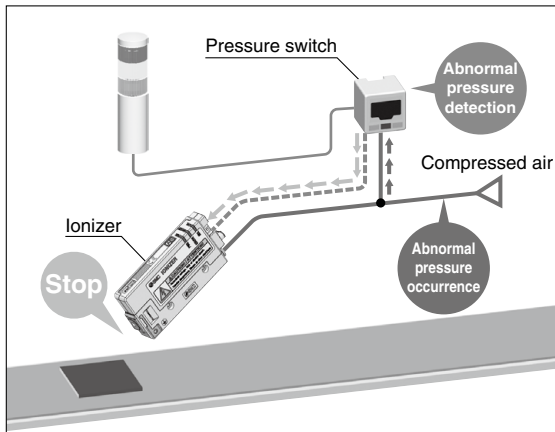

Example Discharge stops when the electrostatic sensor detects that static neutralization has been completed.

- Energy can be saved by stopping discharge when static neutralization is completed.

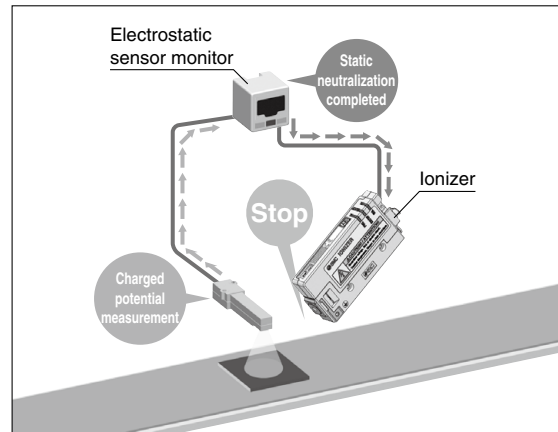

3. Description of LEDs

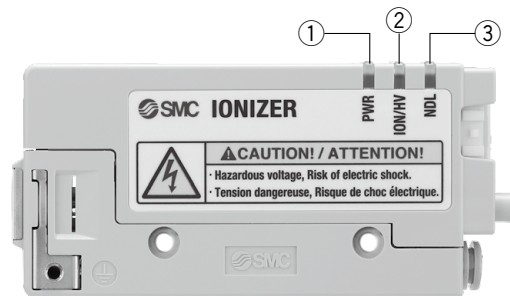

No.	Description	LED	Color	Contents
①	Power supply display	PWR	Green	Lights up when the power supply is turned ON
②	Discharge/Irregular high voltage display	ION/HV	Green/Red	(Green) Lights up during discharge / (Red) Lights up if an abnormal high voltage discharge occurs
③	Maintenance display	NDL	Green	Lights up when lowered static neutralization performance due to the contamination, wear, or breakage of the emitter is detected

LED Color Indication

Item	PWR	ION/HV	NDL	Note
Normal operation (with discharge stop signal ON)	Green	Green	—	Ions are being discharged.
Normal operation (with discharge stop signal OFF)	Green	—	—	Discharge stops.
High voltage error occurred	Green	Red	—	Discharge stops.
External switch signal 1 (with signal ON)	Green	—	—	Discharge stops when the signal is turned ON.
External switch signal 2 (with signal ON)	Green	—	—	
Maintenance warning occurred	Green	Green	Green	Discharge continues.

* The LED is OFF where — is displayed.

4. Alarm

Alarm item	Description	Corrective actions
High voltage error	Gives notification of the occurrence of an abnormal high voltage discharge. The ionizer stops discharging ions, and the ION/HV LED (Red) turns ON. When an error occurs, the signal output is turned OFF.	Turn OFF the power, solve the problem, then turn the power ON again. If the error is solved during operation, turn the reset signal ON and then OFF.
Maintenance warning	Gives notification that emitter maintenance is necessary. The NDL LED turns ON, and the maintenance output signal is turned ON.	Turn OFF the power, clean the emitters, and turn the power ON again.

IZN10E Series

Wiring

No.	Cable color	Description	Signal direction	Wiring requirement*1	Specifications
1	Brown	+24 VDC	IN	○	–
2	Blue	0 V	IN	○	–
3	Orange	Discharge stop signal	IN	○	When the signal is turned OFF, discharge stops.
4	Pink	Reset signal	IN		When the signal is turned ON and then OFF, the error signal is reset. When the signal is turned OFF, normal operation continues.
5	White	Discharge signal	OUT (A contact)		The signal stays ON during discharge.
6	Purple	Error signal	OUT (B contact)		The signal is turned OFF when an error occurs.
7	Yellow	Maintenance signal	OUT (A contact)		The signal is turned ON when maintenance is due.
8	Gray	External switch signal 1	IN		When the signal is turned ON, discharge stops.
9	Light blue	External switch signal 2	IN		When the signal is turned ON, discharge stops.

*1 **Wiring requirement**

○: Minimum wiring requirement for ionizer operation

• Input signal

NPN: The signal is turned ON when the 0 V power supply is connected, and turned OFF when disconnected.

PNP: The signal is turned ON when the +24 VDC power supply is connected, and turned OFF when disconnected.

• Output signal

NPN: The output transistor is energized (by the 0 V power supply inside the ionizer) when the signal is turned ON, and de-energized when turned OFF.

PNP: The output transistor is energized (by the +24 VDC power supply inside the ionizer) when the signal is turned ON, and de-energized when turned OFF.

Provide Grounding

Make sure to ground the ground terminal with a ground resistance of 100 Ω or less.

The ground terminal is used as a reference electric potential for static neutralization.

If the ground terminal is not grounded, the ionizer will not be able to achieve the optimal offset voltage (ion balance).

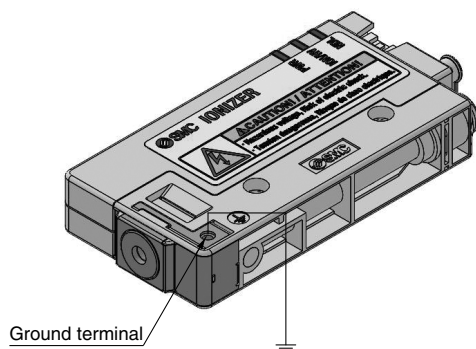

Power Supply Cable Connection Circuit

Make sure to ground the ground terminal with a ground resistance of 100 Ω or less.

The ground terminal is used as a reference electric potential for static neutralization.

If the ground terminal is not grounded, the ionizer will not be able to achieve the optimal offset voltage (ion balance).

■ NPN input/output

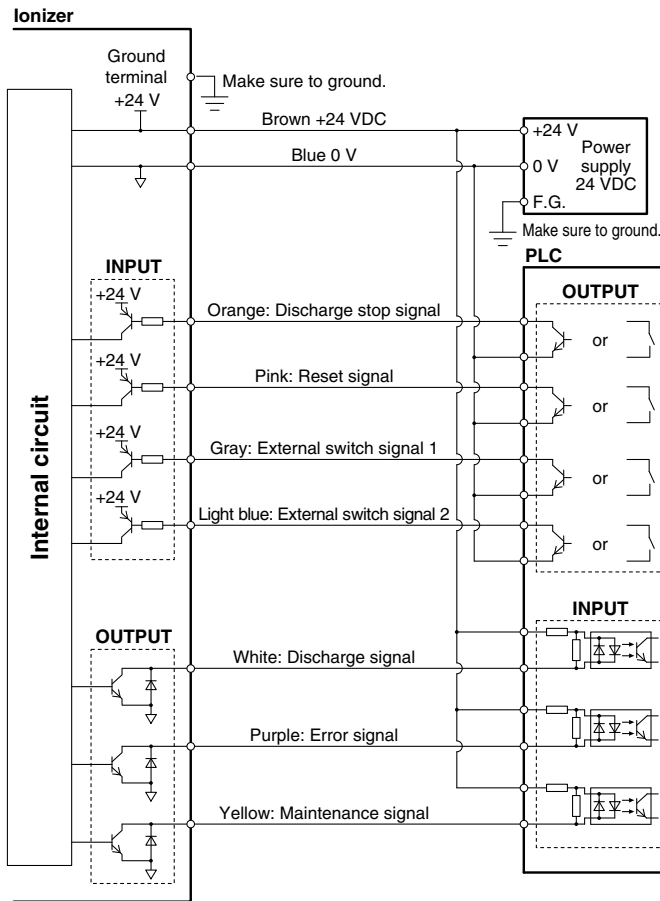

■ PNP input/output

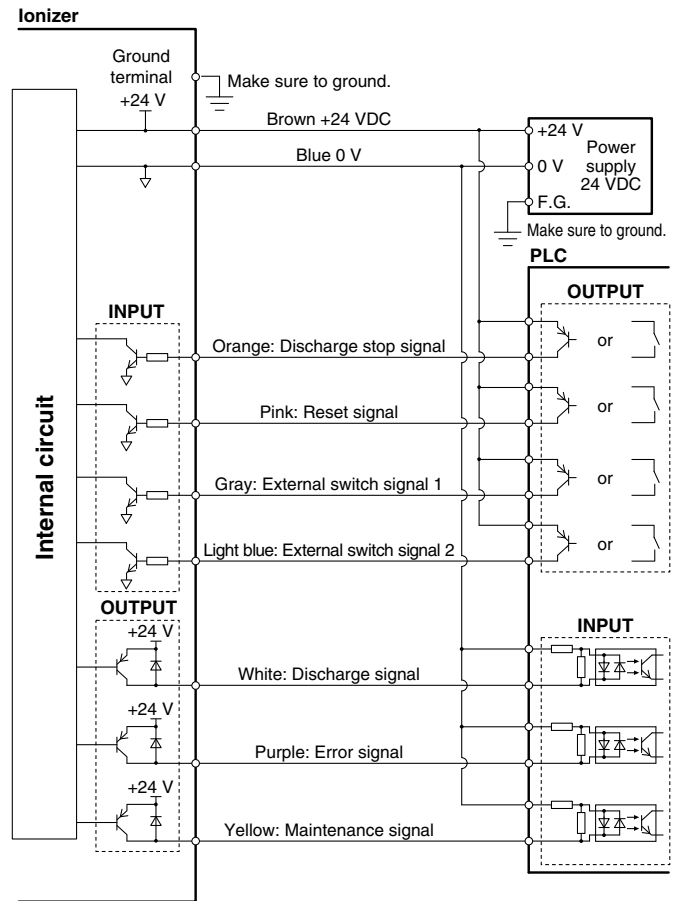

Timing Chart

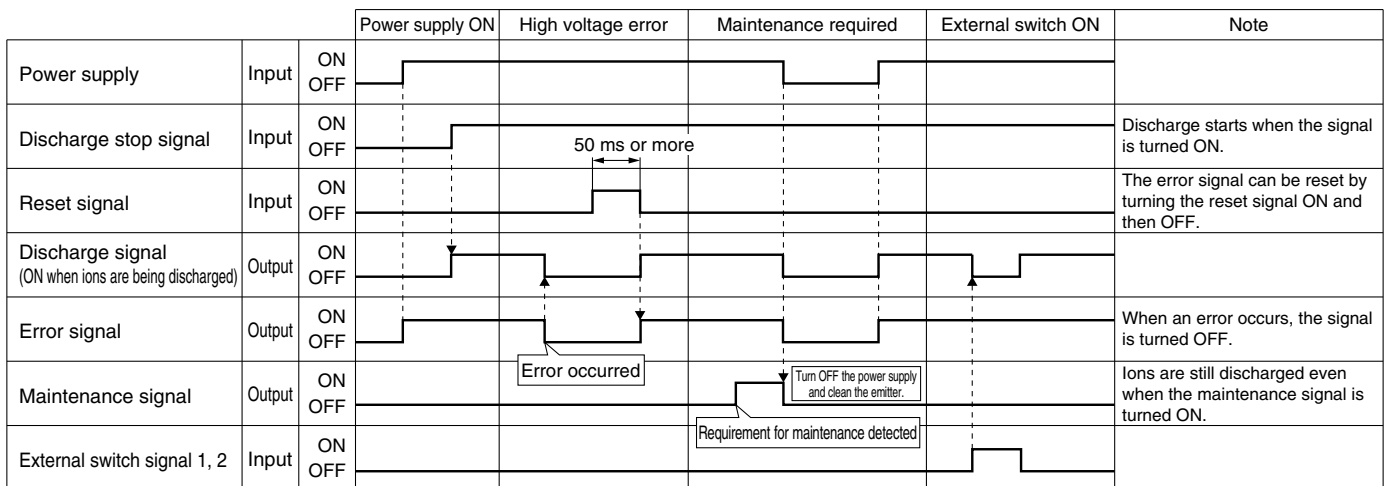

IZN10E Series

Dimensions

Energy saving nozzle IZN10E-01 □⁰⁶₀₇

High flow rate nozzle IZN10E-02 □⁰⁶₀₇

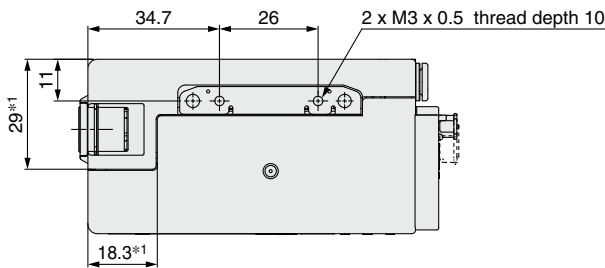
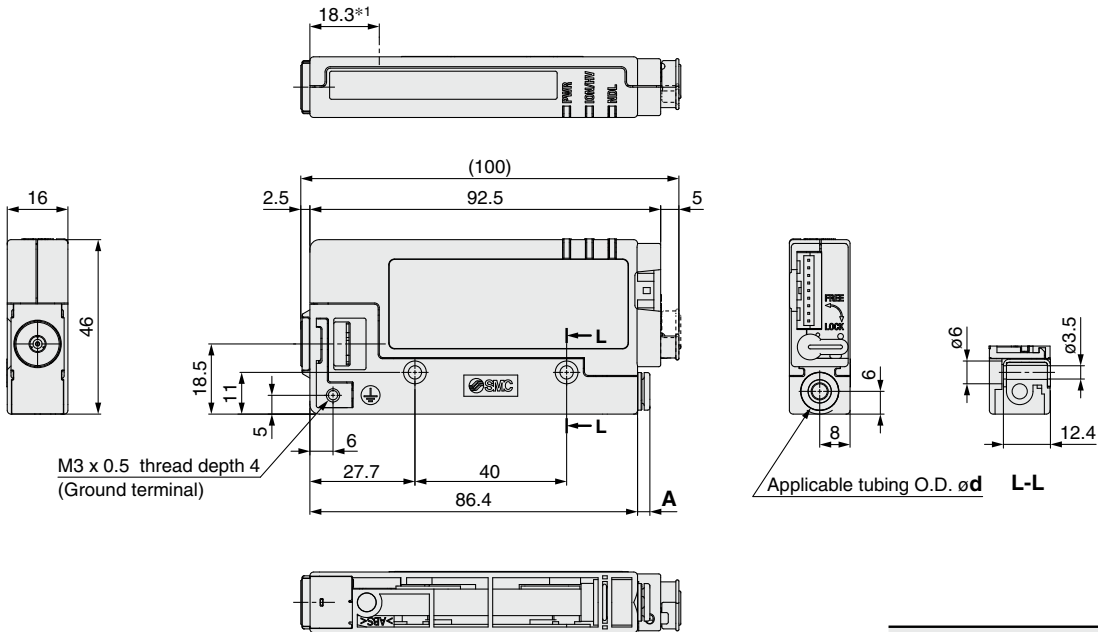

Model	d	A
IZN10E- ⁰¹ ₀₂ □ ⁰⁶	6	3.5
IZN10E- ⁰¹ ₀₂ □ ⁰⁷	1/4"	7

*1 Dimension of the resin part in described in the Mounting Warning note 3 (page 24).

One-touch fitting (Elbow) IZN10E-□□¹⁶₁₇

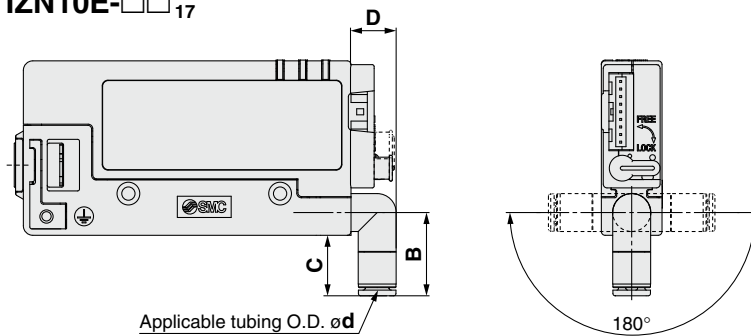

Model	d	B	C	D
IZN10E-□□ ¹⁶	6	22	16	11.5
IZN10E-□□ ¹⁷	1/4"	24.5	18.5	12

Female threads for piping (Rc1/8) IZN10E-11 □□

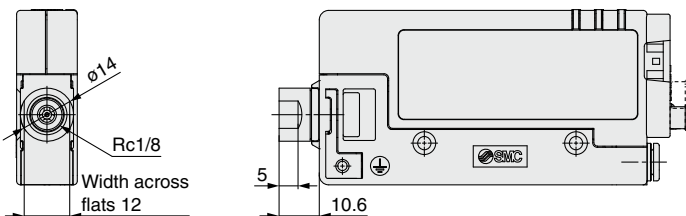

Dimensions

L-bracket IZN10-B1

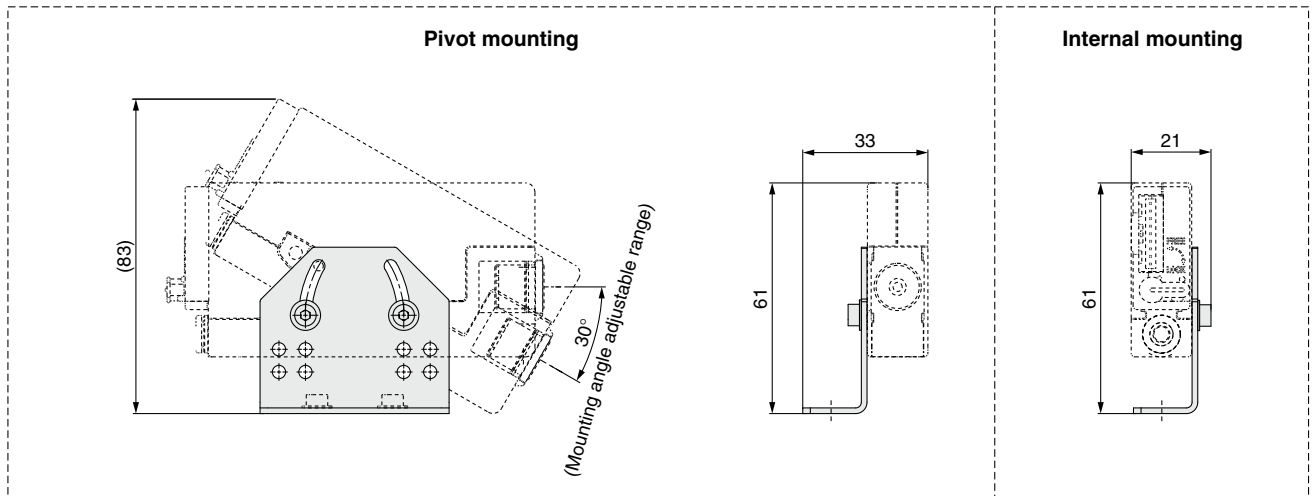
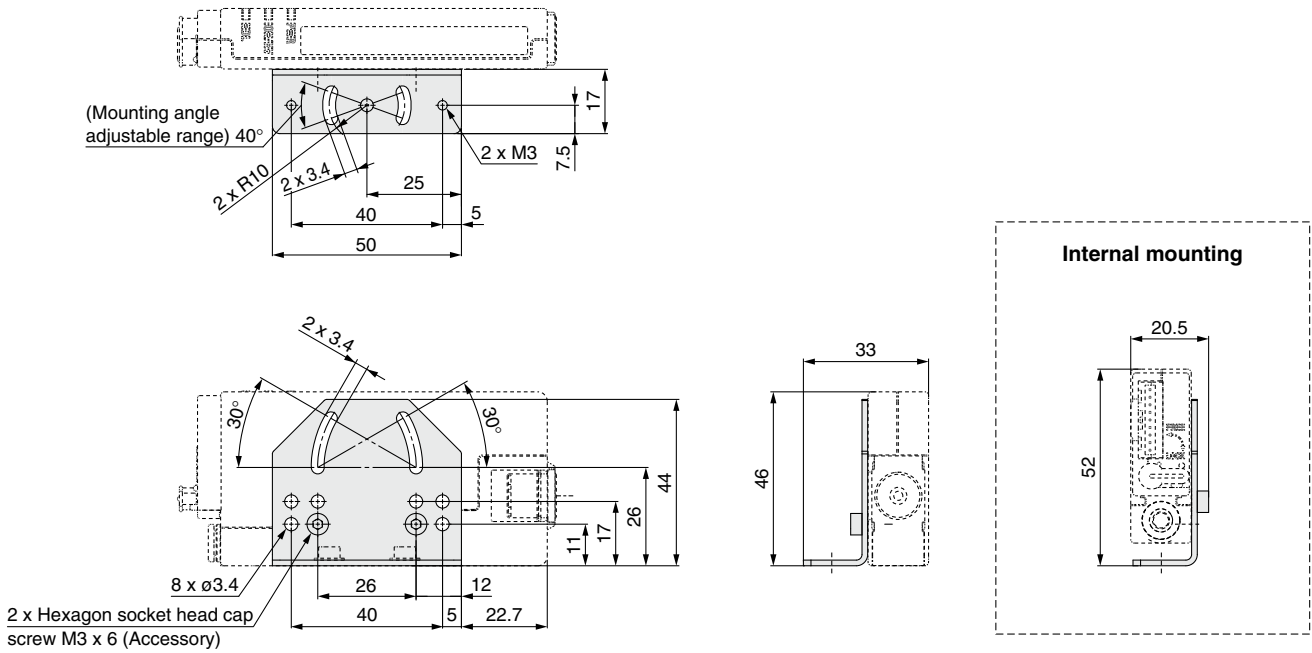

Pivoting bracket IZN10-B2

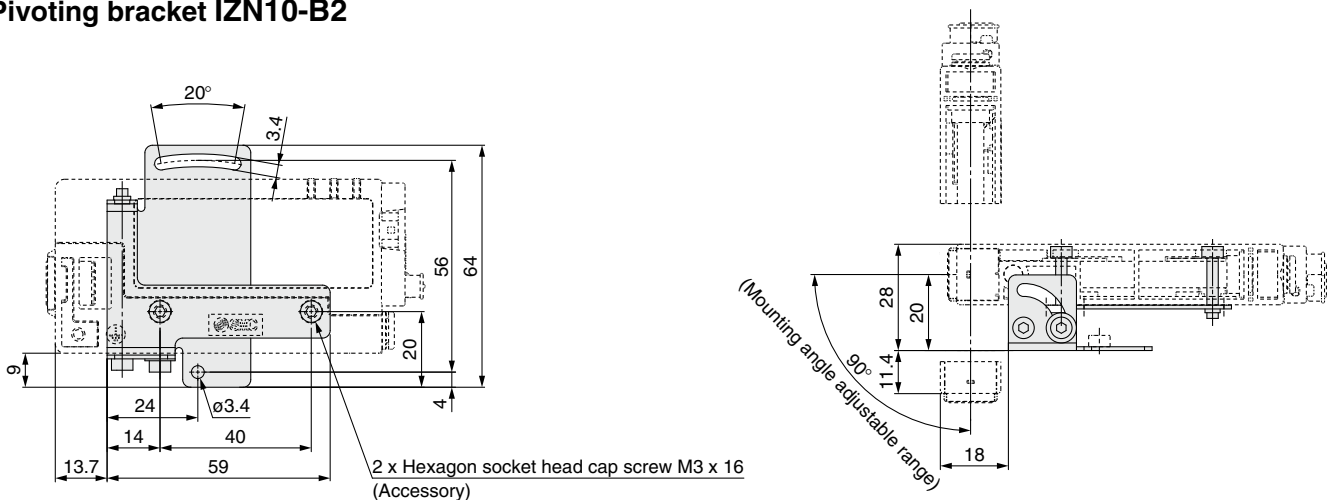

IZN10E Series

Dimensions

DIN rail mounting bracket IZN10-B3

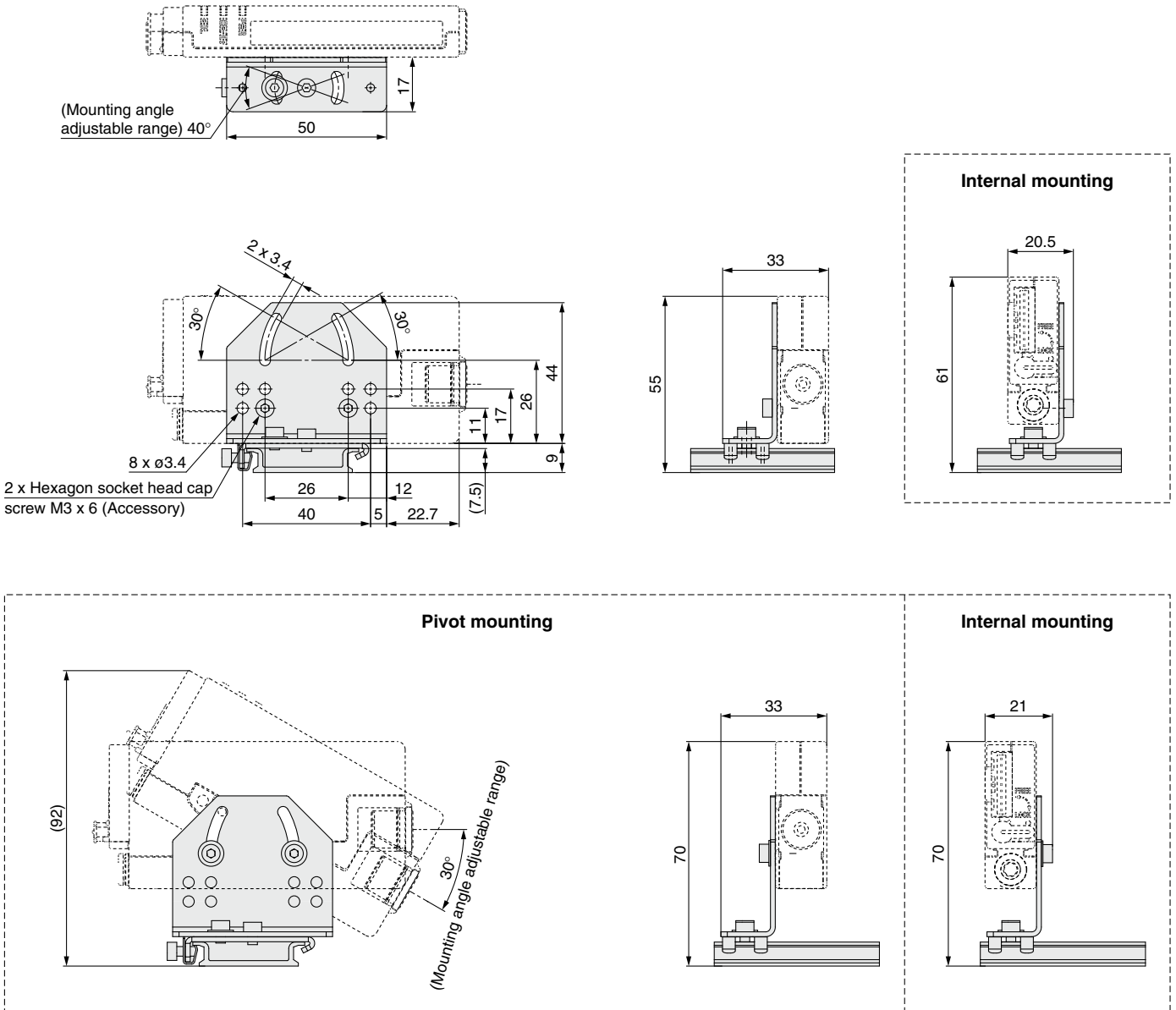

Power supply cable IZN10E-CP□

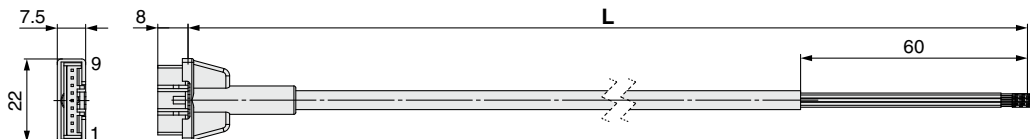

Model	L [mm]
IZN10E-CP	3000
IZN10E-CPZ	9800

Cable Specifications

No. of cable wires/Size		9 cores/AWG26
Conductor	Nominal cross section	0.15 mm ²
	O.D.	0.5 mm
Insulator	O.D.	0.95 mm Brown, Blue, Orange, Pink, White, Purple, Yellow, Gray, Light blue
	Material	Lead-free PVC
Sheath	O.D.	5 mm

IZN10E Series Related Product

This product is an individually applicable product. For details about the delivery time and price, please consult with SMC representative.



Intermittent Control Timer (Made to Order)

Air saving

A digital timer that can control ON/OFF switches of valves etc.

Application: Improved dust removal effect under low air consumption by intermittent ion blowing

- Adjustable frequency: 0.1 to 50.0 Hz
- Set individual ON and OFF times from 0.1 to 99.9 seconds
- Display of accumulated number of pulses
It can be used for maintaining valve or cylinder operations.
- Switch output (Output under timer control)
- 2 types of trigger inputs

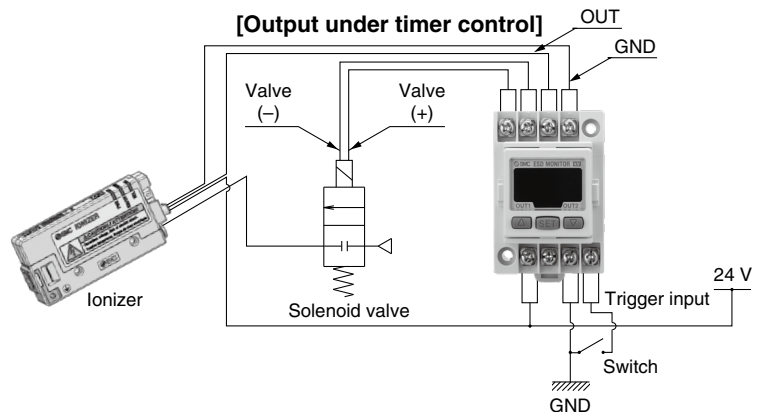
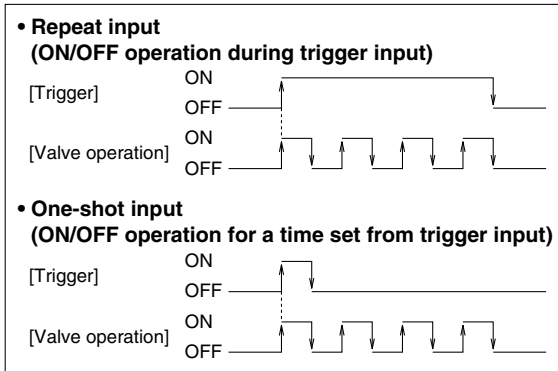
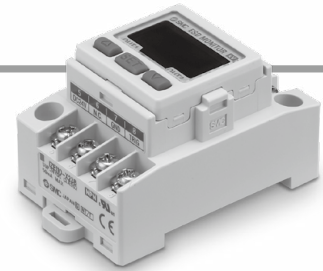

- Solenoid valves up to 24 VDC (4 W) etc. are controllable.

Specifications

Model	IZE110-X238	
Power supply voltage	24 VDC $\pm 10\%$ (with power supply polarity protection)	
Current consumption	50 mA or less (Single unit only)	
Connection valve	24 VDC 4 W or less	
OUT*1	Max. load current	80 mA
	Max. load voltage	30 VDC
	Residual voltage	1 V or less (at load current of 80 mA)
	Short circuit protection	With short circuit protection
Trigger input	No-voltage input, Low level input 10 ms or more, Low level 0.4 V or less	
Indicator light	(Green/Red)	
Environmental resistance	Enclosure	IP40
	Operating temperature range	Operating: 0 to 50°C, Stored: -10 to 60°C (with no freezing or condensation)
	Operating humidity range	Operating/Stored: 35 to 85% RH (with no condensation)
	Withstand voltage	1000 VAC for 1 minute between terminals and housing
	Insulation resistance	50 M Ω or more (500 VDC measured via megohmmeter), between terminals and housing
Vibration resistance	10 to 150 Hz at whichever is smaller of 1.5 mm amplitude or 20 m/s ² acceleration, in X, Y, Z direction for 2 hrs. each (De-energized)	
Impact resistance	100 m/s ² in X, Y, Z directions 3 times each (De-energized)	
Material	Front case: PBT, Rear case: Modified PPE	
Weight	50 g	

*1 Do not use a load that generates surge voltage.

Dimensions / Input/Output Circuit

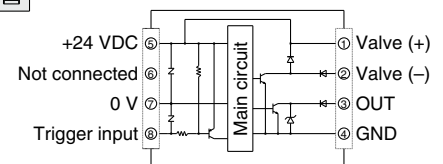
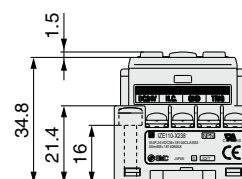
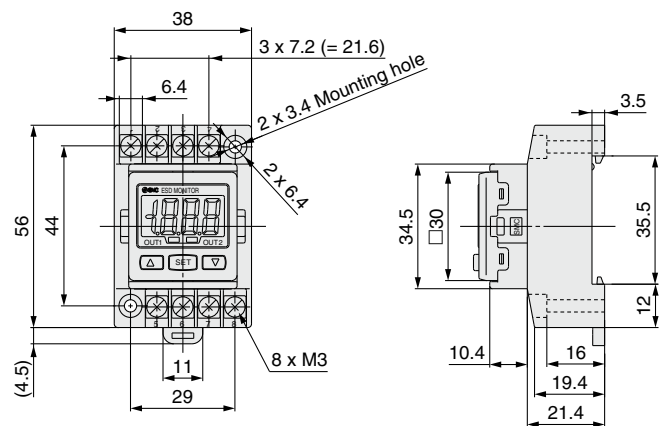

Input/Output circuit

IZN10E Series

Made to Order 1

This product is an individually applicable product. For details about the delivery time and price, please consult with SMC representative.



How to Order

With right angles

IZN10E - 01 [] [] [] - [] - X367

Nozzle type

Symbol	Type
01	Energy saving nozzle
02	High flow rate nozzle

Nozzle with right angles

Refer to the standard product number on page 10.



Specifications (Specifications other than those shown below are the same as the standard product. Refer to page 11.)

Ionizer model		IZN10E-□-X367 (NPN specification)	IZN10E-□P-X367 (PNP specification)
Offset voltage*1	Energy saving nozzle	Within ±10 V	
	High flow rate nozzle	Within ±30 V	

*1 Measurement values based on a charged plate (dimensions: 150 mm x 150 mm, capacitance: 20 pF) defined by ANSI standard (ANSI/ESD STM3.1-2015). The distance between the charged plate and the ionizer: 100 mm, the air purge is 0.3 MPa (energy saving nozzle) / 0.1 MPa (high flow rate nozzle).

Installation Distance — Discharge Time Characteristics (Discharge Time from +1000 V to +100 V)

① Energy saving nozzle / IZN10E-01-X367

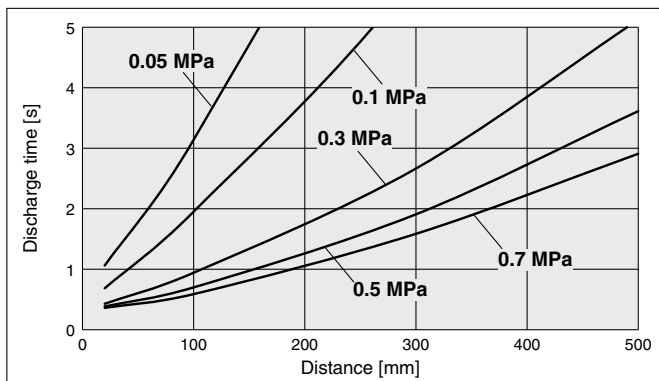

② High flow rate nozzle / IZN10E-02-X367

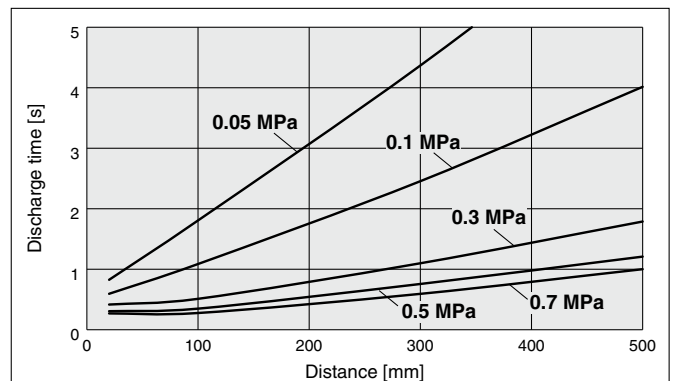

Pressure — Flow Rate Characteristics

① Energy saving nozzle / IZN10E-01-X367

② High flow rate nozzle / IZN10E-02-X367

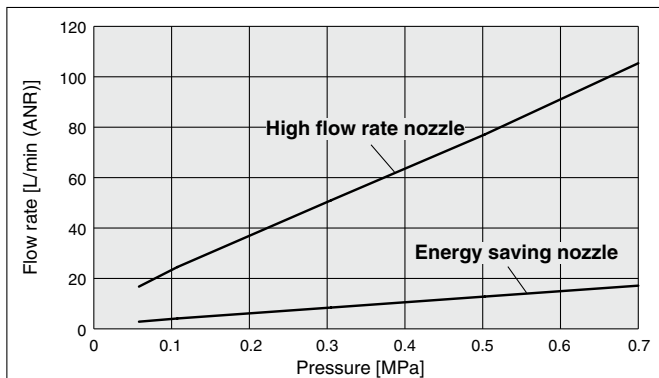

* Static neutralization characteristics are based on data using a charged plate (dimensions: 150 mm x 150 mm, capacitance: 20 pF) as defined in the U.S. ANSI standards (ANSI/ESD STM3.1-2015). Use this data only as a guideline for model selection because the values vary depending on the material and/or size of the subject.

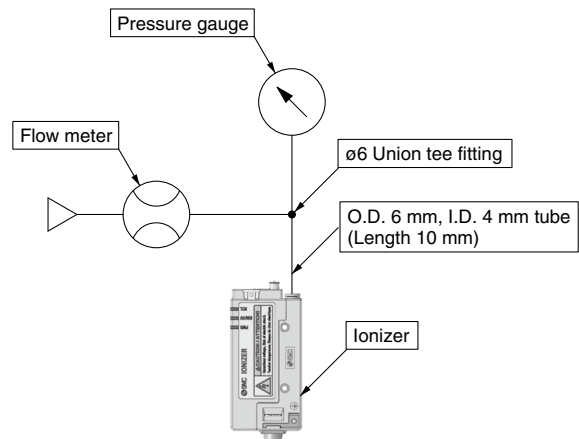

Dimensions

Energy saving nozzle IZN10E-01-X367

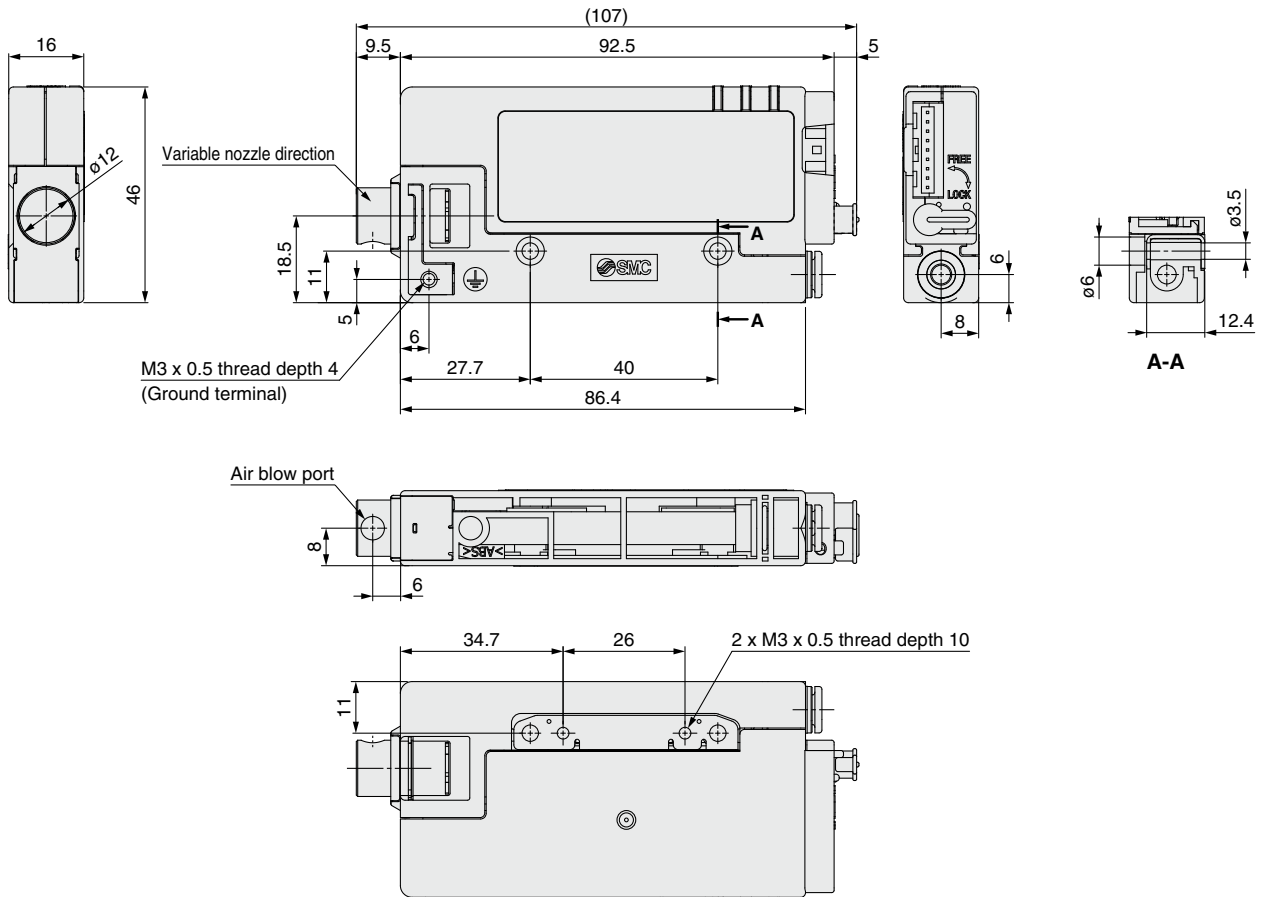

High flow rate nozzle IZN10E-02-X367

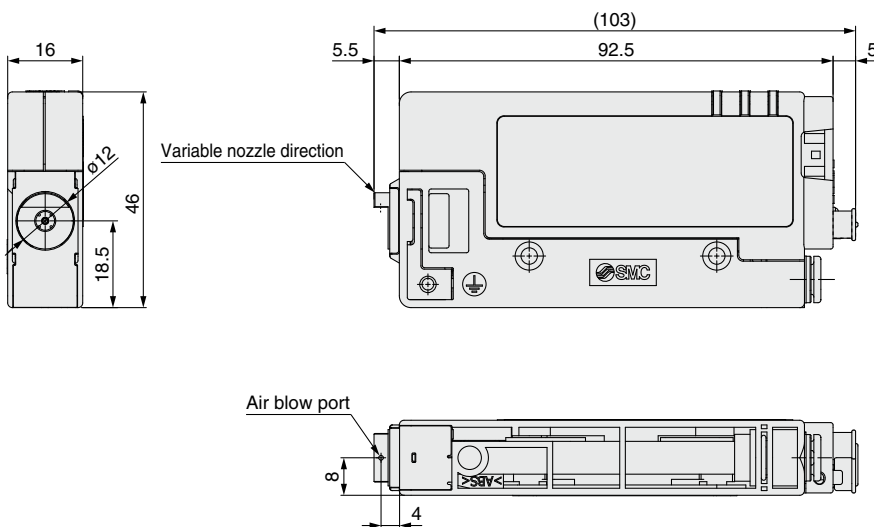

IZN10E Series

Made to Order 2

This product is an individually applicable product. For details about the delivery time and price, please consult with SMC representative.



Nozzle Variations

For the ionizer, please select the female threads for piping (Rc1/8). (Refer to the How to Order on page 10.)

Circular diffusion nozzle

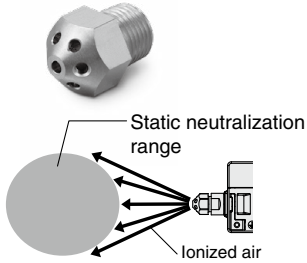

Part no.
IZN10-G-X198

Supply pressure specifications:
0.05 to 0.1 MPa

Flat diffusion nozzle

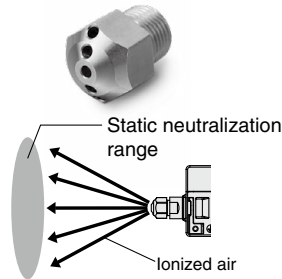

Part no.
IZN10-G-X199

Supply pressure specifications:
0.05 to 0.1 MPa



IZN10E-11

Bar nozzle (Straight type)

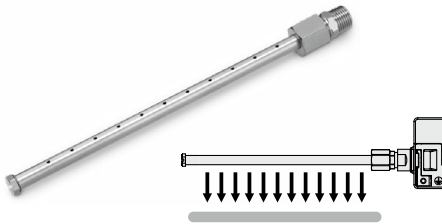

Part no.	Bar length [mm]
IZN10-G-100-X216	100
IZN10-G-200-X216	200
IZN10-G-300-X216	300
IZN10-G-400-X216	400
IZN10-G-500-X216	500
IZN10-G-600-X216	600

Supply pressure specifications:
0.05 to 0.1 MPa

Circumferential jet bar nozzle (Straight type)

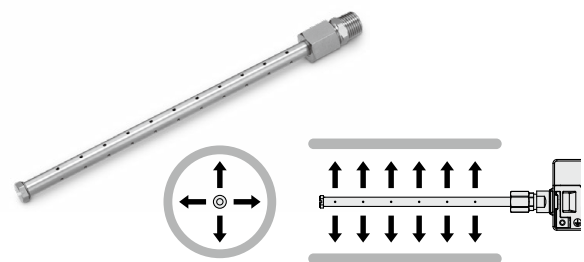

Part no.	Bar length [mm]
IZN10-G-X278	150

Supply pressure specifications:
0.05 to 0.15 MPa

Bender tube nozzle

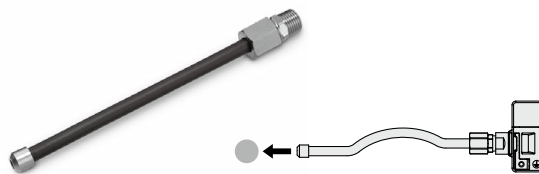

Part no.	Bar length [mm]
IZN10-G-100-X205	100
IZN10-G-200-X205	200
IZN10-G-300-X205	300
IZN10-G-400-X205	400
IZN10-G-500-X205	500
IZN10-G-600-X205	600

If the tubing is bent for use, maintain a minimum bending radius of 20 mm.
Supply pressure specifications:
0.05 to 0.15 MPa

Long nozzle

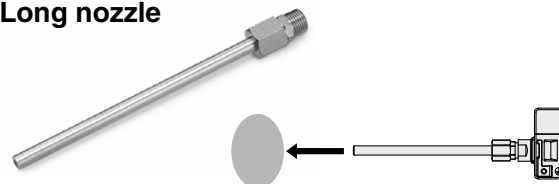

Part no.	Bar length [mm]
IZN10-G-100-X226	100
IZN10-G-200-X226	200
IZN10-G-300-X226	300
IZN10-G-400-X226	400
IZN10-G-500-X226	500
IZN10-G-600-X226	600

Supply pressure specifications:
0.05 to 0.15 MPa



IZN10E Series Specific Product Precautions 1

Be sure to read this before handling the products.
Refer to the back cover for safety instructions.

Selection

Warning

1. This product is intended to be used with general factory automation (FA) equipment.

If considering using the product for other applications (especially those indicated in warning (4) on the back cover), please consult with SMC beforehand.

2. Use this product within the specified voltage and temperature range.

Using outside of the specified voltage, temperature, or humidity range can cause a malfunction, damage, electrical shock, or fire.

3. Use clean compressed air as fluid.

This product is not explosion proof. Never use a flammable gas or an explosive gas as a fluid and never use this product in the presence of such gases.

Please contact us when fluids other than compressed air are used.

4. This product is not explosion-protected.

Never use this product in locations where the explosion of dust is likely to occur or flammable or explosive gases are used. This can cause a fire.

Caution

1. This product is not washed. When bringing into a clean room, flush for several minutes and confirm the required cleanliness before use.

Mounting

Warning

1. Reserve enough space for maintenance, piping and wiring.

Please take into consideration that the One-touch fittings for supplying air, need enough space for the air tubing to be easily attached/detached.

To avoid excessive stress on the connector and One-touch fitting, please take into consideration the cable and air tube minimum bending radius and avoid bending at acute angles.

Wiring with excessive twisting, bending, etc. can cause a malfunction, wire breakage, fire, or air leakage.

Minimum bending radius: Power supply cable.....30 mm

(Note: Shown above is wiring with the fixed minimum allowable bending radius and at a temperature of 20°C. If used under this temperature, the connector can receive excessive stress even though the minimum bending radius is allowable.)

Regarding the minimum bending radius of the air tubing, refer to the operation manual or catalog for tubing.

2. When installing the product directly on a mounting surface, mount it on a flat surface.

Mounting on an uneven surface will apply excess force to the ionizer body, which leads to damage or failure. Do not drop the product or subject it to a strong impact. This may cause an injury or accident.

Mounting

Warning

3. Keep the area specified clear when the product is mounted directly on to a mounting surface or workpiece which is connected to ground.

Install the product with the mounting surface or workpiece avoiding the shaded area in the drawing below. If the grounded mounting surface or workpiece is too close to the shaded area, the ozone concentration inside the product may increase, causing failure of the product, depending on the operating conditions.

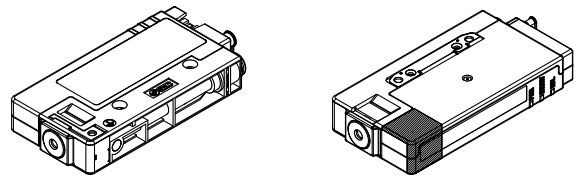

* Refer to the Dimensions (page 17) for dimensions of the shaded area.

4. Do not cover the external air intake port of the energy saving nozzle.

The energy saving nozzle uses external air. The external air intake port is located in part A and part B. When installing an energy saving nozzle, do not cover the two external air intake ports. If the external air flow is blocked, product performance will be reduced.

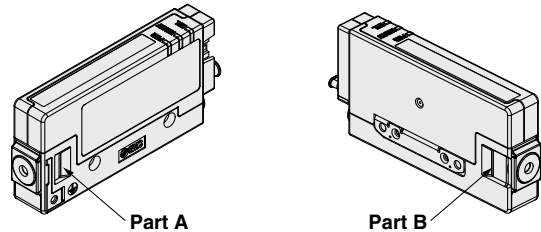

5. Avoid using in a place where noise (electromagnetic wave and surge) is generated.

If the product is used in an environment where noise is generated, it may lead to a malfunction and deterioration or damage of the internal elements. Take measures to prevent noise at its source and avoid power and signal lines from coming into close contact.

6. Use the correct tightening torque. Refer to the table below for tightening torque for screws.

If the screws are tightened in excess of the specified torque range, it may damage the mounting screws, mounting brackets, etc. If the tightening torque is insufficient, the mounting screws and brackets may become loose.

Thread size	Recommended tightening torque
M3	0.61 to 0.63 N·m



IZN10E Series

Specific Product Precautions 2

Be sure to read this before handling the products.
Refer to the back cover for safety instructions.

Mounting

⚠ Warning

7. Do not allow foreign matter or tools to enter the nozzle.

The inside of the nozzle contains emitters. If a metal tool makes contact with the emitters, it can cause electric shock, resulting in a sudden movement by the operator that can cause further injuries such as hitting the body on peripheral equipment. Also, if the tool damages the emitter, the ionizer may fail or cause an accident.

⚠ Danger High Voltage

Emitters are under high voltage. Never touch them as there is a danger of electric shock or injury due to an evasive action against a momentary electrical shock caused by inserting foreign matter in the cartridge or touching the emitter.

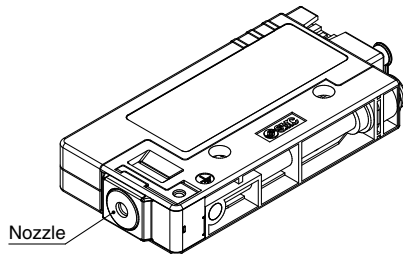

8. Do not apply moment to the nozzle.

A moment force may be applied to the nozzle depending on the shape of the nozzle attached to the female piping thread. It is possible that the nozzle or ionizer body will be damaged if vibration occurs. If a moment of 0.05 N·m or more will be applied, mount a support to the middle part of the nozzle so that the moment is not applied to the nozzle.

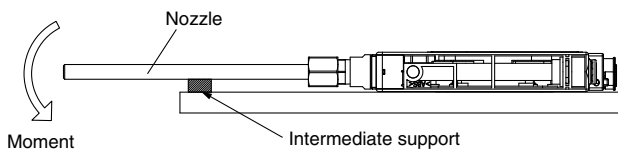

9. Do not apply tape or stickers to the product body.

If a tape or seal contains any conductive adhesive or reflective paint, a dielectric phenomenon may occur due to the generated ions, resulting in electrostatic charge or electric leakage.

10. Ensure the power supply is removed before installing and adjusting the product.

Wiring / Piping

⚠ Warning

1. Before wiring, ensure that the power supply capacity is enough and that the voltage is within the specification.

2. To maintain product performance, the power supply shall be UL listed Class 2 certified by National Electric Code (NEC) or evaluated as a limited power source provided by UL60950.

3. Be sure to ground with a ground resistance of 100 Ω or less to maintain the product performance.

If such grounding is not provided, not only may static electricity removal capability be disrupted but electric shocks may also result and the ionizer or power supply may break down.

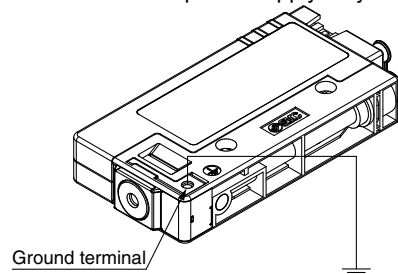

4. Wiring (including insertion and removal of the connector) should never be carried out with the power supply ON.

5. Ensure the safety of wiring and surrounding conditions before supplying power.

6. Do not connect or disconnect the connectors (including power source) while the power is supplied. Failure to follow this procedure may cause product malfunction.

7. If the ionizer wiring and high power lines are routed together, this product may malfunction due to noise. Therefore, use a separate wiring route for this product.

8. Confirm that the wiring is correct before operation.

Incorrect wiring will lead to product damage or malfunction.

9. Flush the piping before use.

Before using this product, exercise caution to prevent particles, water drop, or oil contents from entering the piping.

Operating Environment / Storage Environment

⚠ Warning

1. Do not use this product in an enclosed space.

This product utilizes a corona discharge phenomenon. Do not use the product in an enclosed space as ozone and nitrogen oxides exist in such places, even though in marginal quantities. Also, ozone condensation can increase if used in an enclosed space, which can affect the human body, so ventilation is necessary. Even if ventilation is secured, the use of multiple ionizers in a narrow space can increase ozone condensation. Therefore, check that ozone condensation is not more than a standard value of 0.1 ppm in the operating environment while the ionizer is in operation.



IZN10E Series

Specific Product Precautions 3

Be sure to read this before handling the products.
Refer to the back cover for safety instructions.

Operating Environment / Storage Environment

Warning

2. Take preventative measures against ozone.

Equipment used around this product should have ozone-prevention measures. Also, regularly check that there is no deterioration due to ozone.

3. Be sure to supply air.

If air is not supplied, not only is the static neutralization effected, but also the ozone and nitrogen oxides generated in the ion generator accumulates, which causes an adverse effect on the inside of the product, or peripheral equipment. Be sure to supply air during a discharge.

When the product is used for intermittent ion blow, pressure fluctuations in the air supply can cause instability in the corona discharge of the ion generation, resulting in difficulty maintaining the offset voltage specification. Be sure to confirm that there are no problems with the static neutralization.

4. Observe the ambient temperature range.

The ambient temperature range is 0 to 55°C for the ionizer. Do not use the product in locations where the ambient temperature changes suddenly even within the specifications or if the temperature difference of the fluid relative to the ambient temperature is large condensation may occur.

5. Environments to avoid

Avoid using and storing this product in the following environments since they may cause damage to this product.

- Areas where the ambient temperature exceeds the range of 0 to 55°C
- Areas where the ambient humidity exceeds the range of 35 to 65% Rh
- Areas where abrupt temperature changes may cause condensation
- Areas where corrosive gas, flammable gas or other volatile flammable substances are stored
- Areas where the product may be exposed to conductive powder such as iron powder or dust, oil mist, salt, organic solvent, machining chips, particles or cutting oil (including water and any liquids), etc.
- Paths of direct air flow, such as air conditioners
- Enclosed or poorly ventilated areas
- Locations which are exposed to direct sunlight or heat radiation
- Areas where strong electromagnetic noise is generated, such as strong electrical and magnetic fields or supply voltage spikes
- Areas where the product is exposed to static electricity discharge
- Locations where strong high frequency is generated
- Locations that are subject to potential lightning strikes
- Areas where the product may receive direct impact or vibration
- Areas where the product may be subjected to forces or weight that could cause physical deformation

6. Do not use an air containing mist or dust.

The air containing mist or dust will cause the performance to decrease and shorten the maintenance cycle.

Supply clean compressed air (compressed air quality of Class 2.4.3, 2.5.3, 2.6.3 or higher according to ISO 8573-1: 2010 (JIS B 8392-1: 2012) is recommended for operation) by using an air dryer (IDF series), air filter (AF/AFF series), and mist separator (AFM/AM series).

7. This product does not incorporate protection against lightning surges.

8. Effects on implantable medical devices

The electromagnetic waves emitted from this product may interfere with implantable medical devices such as cardiac pacemakers and cardioverter defibrillators, resulting in the malfunction of the medical device or other adverse effects.

Please use extreme caution when operating equipment which may have an adverse effect on your implantable medical device. Be sure to thoroughly read the precautions stated in the catalog, operation manual, etc., of your implantable medical device, or contact the manufacturer directly for further details on what types of equipment need to be avoided.

Maintenance

Warning

1. Periodically inspect the ionizer and clean the emitters.

Check regularly if the product is operating with undetected failures or not. The maintenance must be performed by an operator who has sufficient knowledge and experience. If the product is used for an extended period with dust present on the emitters, the static neutralization performance will be reduced. Since the energy saving nozzle is equipped with an ambient air introduction mechanism, it is easier to be affected by the ambient air compared with the high flow rate nozzle or the female threads for piping, and dust tends to adhere to the emitter more quickly. Clean the emitter when the maintenance LED turns ON.

If the emitter becomes worn and the static neutralization performance is not restored after cleaning, replace the emitter.

Danger High Voltage

This product contains a high voltage generation circuit. When performing maintenance inspection, be sure to confirm that the power supply to the ionizer is turned off. Never disassemble or modify the ionizer, as this may not only impair the product's functionality but could cause an electric shock or electric leakage.

2. The tube and fitting must be treated as consumable parts.

The tube and fitting that are connected to the female piping ports can deteriorate due to ozone and need to be replaced regularly or use an ozone resistant type.

3. Cleaning the emitter or replacing the cartridge assembly should never be performed while the power and compressed air is supplied to the product.

Touching an emitter when it is electrified may result in electric shock or other accidents.

If the cartridge assembly is removed while compressed air is supplied, the cartridge assembly will shoot out.

If cartridge assemblies are not securely installed, there is a danger that they may shoot out or fall when compressed air is supplied.

4. Do not disassemble or modify the product.

Otherwise, an electrical shock, damage and/or a fire may occur. Also, the disassembled or modified products may not achieve the performances guaranteed in the specifications, and exercise caution because the product will not be warranted.

5. Do not operate the product with wet hands.

Otherwise, an electric shock or accident may occur.

Handling

Warning

1. Do not drop, hit or apply excessive shock (100 m/s² or more) to the product when handling it.

Even if the product appears undamaged, the internal components may be damaged, leading to a malfunction.

2. When mounting/dismounting the cable, use your finger to pinch the claw of the connector, then attach/detach it correctly. Otherwise, connector mounting section may be damaged and cause a disorder.

Safety Instructions

These safety instructions are intended to prevent hazardous situations and/or equipment damage. These instructions indicate the level of potential hazard with the labels of “**Caution**,” “**Warning**” or “**Danger**.” They are all important notes for safety and must be followed in addition to International Standards (ISO/IEC)*1), and other safety regulations.

 **Caution:** **Caution** indicates a hazard with a low level of risk which, if not avoided, could result in minor or moderate injury.

 **Warning:** **Warning** indicates a hazard with a medium level of risk which, if not avoided, could result in death or serious injury.

 **Danger :** **Danger** indicates a hazard with a high level of risk which, if not avoided, will result in death or serious injury.

*1) ISO 4414: Pneumatic fluid power – General rules relating to systems.
ISO 4413: Hydraulic fluid power – General rules relating to systems.
IEC 60204-1: Safety of machinery – Electrical equipment of machines.
(Part 1: General requirements)
ISO 10218-1: Manipulating industrial robots – Safety.
etc.

Warning

1. The compatibility of the product is the responsibility of the person who designs the equipment or decides its specifications.

Since the product specified here is used under various operating conditions, its compatibility with specific equipment must be decided by the person who designs the equipment or decides its specifications based on necessary analysis and test results. The expected performance and safety assurance of the equipment will be the responsibility of the person who has determined its compatibility with the product. This person should also continuously review all specifications of the product referring to its latest catalog information, with a view to giving due consideration to any possibility of equipment failure when configuring the equipment.

2. Only personnel with appropriate training should operate machinery and equipment.

The product specified here may become unsafe if handled incorrectly. The assembly, operation and maintenance of machines or equipment including our products must be performed by an operator who is appropriately trained and experienced.

3. Do not service or attempt to remove product and machinery/equipment until safety is confirmed.

1. The inspection and maintenance of machinery/equipment should only be performed after measures to prevent falling or runaway of the driven objects have been confirmed.
2. When the product is to be removed, confirm that the safety measures as mentioned above are implemented and the power from any appropriate source is cut, and read and understand the specific product precautions of all relevant products carefully.
3. Before machinery/equipment is restarted, take measures to prevent unexpected operation and malfunction.

4. Contact SMC beforehand and take special consideration of safety measures if the product is to be used in any of the following conditions.

1. Conditions and environments outside of the given specifications, or use outdoors or in a place exposed to direct sunlight.
2. Installation on equipment in conjunction with atomic energy, railways, air navigation, space, shipping, vehicles, military, medical treatment, combustion and recreation, or equipment in contact with food and beverages, emergency stop circuits, clutch and brake circuits in press applications, safety equipment or other applications unsuitable for the standard specifications described in the product catalog.
3. An application which could have negative effects on people, property, or animals requiring special safety analysis.
4. Use in an interlock circuit, which requires the provision of double interlock for possible failure by using a mechanical protective function, and periodical checks to confirm proper operation.

Caution

1. The product is provided for use in manufacturing industries.

The product herein described is basically provided for peaceful use in manufacturing industries.
If considering using the product in other industries, consult SMC beforehand and exchange specifications or a contract if necessary.
If anything is unclear, contact your nearest sales branch.

Limited warranty and Disclaimer/ Compliance Requirements

The product used is subject to the following “Limited warranty and Disclaimer” and “Compliance Requirements”.

Read and accept them before using the product.

Limited warranty and Disclaimer

1. The warranty period of the product is 1 year in service or 1.5 years after the product is delivered, whichever is first.*2)
Also, the product may have specified durability, running distance or replacement parts. Please consult your nearest sales branch.
2. For any failure or damage reported within the warranty period which is clearly our responsibility, a replacement product or necessary parts will be provided.
This limited warranty applies only to our product independently, and not to any other damage incurred due to the failure of the product.
3. Prior to using SMC products, please read and understand the warranty terms and disclaimers noted in the specified catalog for the particular products.

*2) Vacuum pads are excluded from this 1 year warranty.

A vacuum pad is a consumable part, so it is warranted for a year after it is delivered.
Also, even within the warranty period, the wear of a product due to the use of the vacuum pad or failure due to the deterioration of rubber material are not covered by the limited warranty.

Compliance Requirements

1. The use of SMC products with production equipment for the manufacture of weapons of mass destruction (WMD) or any other weapon is strictly prohibited.
2. The exports of SMC products or technology from one country to another are governed by the relevant security laws and regulations of the countries involved in the transaction. Prior to the shipment of a SMC product to another country, assure that all local rules governing that export are known and followed.

Caution

SMC products are not intended for use as instruments for legal metrology.

Measurement instruments that SMC manufactures or sells have not been qualified by type approval tests relevant to the metrology (measurement) laws of each country. Therefore, SMC products cannot be used for business or certification ordained by the metrology (measurement) laws of each country.

Revision History

Revision	Description
Edition B	* The contents of the technical data have been revised. * Information on the effects on implantable medical devices has been added to the specific product precautions.
	YR

Safety Instructions

Be sure to read the “Handling Precautions for SMC Products” (M-E03-3) and “Operation Manual” before use.