

New

Compact Guide Cylinder with Lock

ø20, ø25, ø32, ø40, ø50, ø63, ø80, ø100

Weight **Max.**
17% lighter
Compared with the existing MLGPL80, 25 mm stroke

Guide rod **Max.**
22 mm shorter
Compared with the existing MLGPM40, 25 mm stroke



Stopping possible at any stroke position

- Small auto switches can be directly mounted. Construction without bracket saves mounting time.
- Mounting dimensions, performance, and strength (rigidity) are equivalent to the existing MLGP series.

Drop prevention when the pressure is decreased or the residual pressure is released

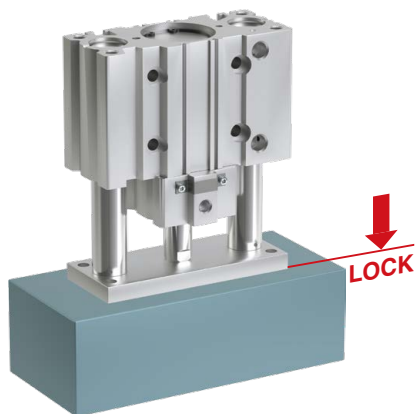

Drop prevention for press fitting jig

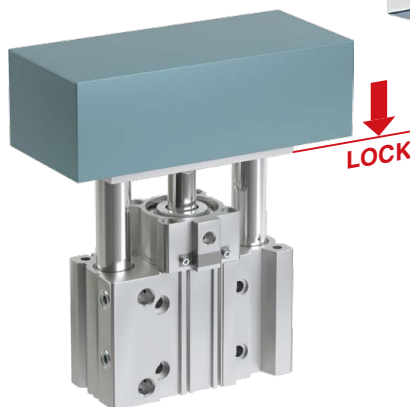

Drop prevention for lifter

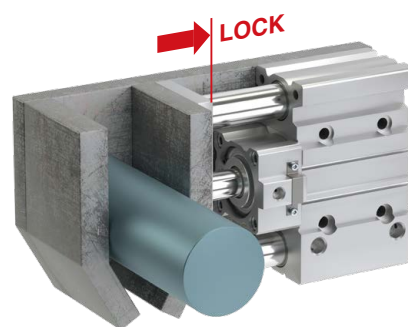

Holding a clamped condition

MLGP Series



CAT.ES20-258A

Stopping possible at any stroke position

Simple and reliable locking mechanism is effective in drop prevention when there is a pressure loss.

Locked

Unlocking port: Air exhausted

1. The lock ring is tilted by the spring force.
2. The tilting is increased by the load and the piston rod is securely locked.

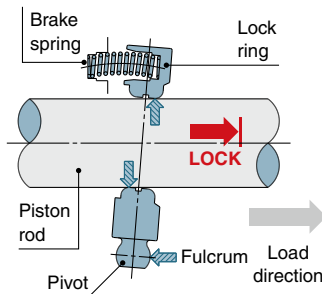

Unlocked

Unlocking port: Air supplied

1. The lock ring becomes perpendicular to the piston rod, creating clearance between the piston rod and lock ring, which allows the piston rod to move freely.

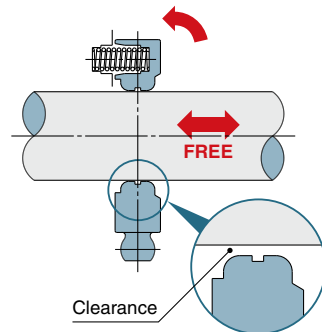

Low profile with compact lock unit



Same dimensions as those of the standard MGP series

	[mm]							
Bore size	20	25	32	40	50	63	80	100
Lock unit length	26.5	30.5	31.5	34	35	38	43	51.5

Easy manual unlocking

Locked



Unlocked



ø20 to ø32

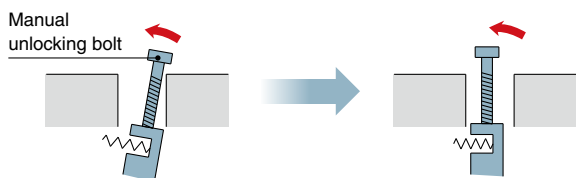

ø40 to ø100

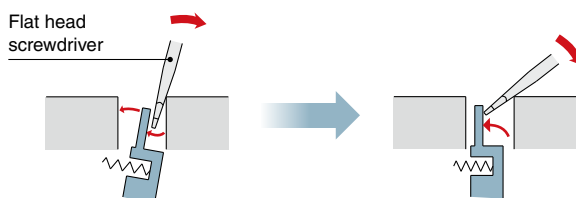

* For details, refer to page 32.

Locking direction is selectable.

* The symbol for the cylinder with lock in the pneumatic circuit uses SMC original symbol.

Extension locking

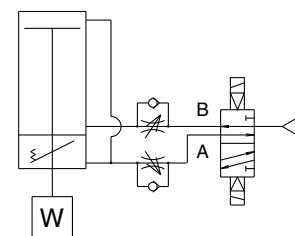

Retraction locking

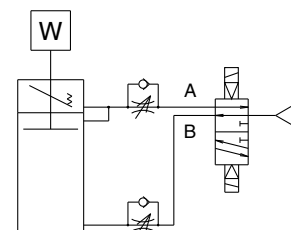

Weight reduced by up to 17% with a shorter guide rod and thinner plate

Weight: Max. 17% lighter

(Compared with the existing MLGPL)

Bore size [mm]	New MLGPL	Existing model MLGPL	Reduction rate [%]
ø20	0.75	0.86	13
ø25	1.11	1.22	9
ø32	1.73	1.89	8
ø40	2.00	2.16	7
ø50	3.31	3.69	10
ø63	4.24	4.77	11
ø80	6.76	8.11	17
ø100	13.4	14.7	9

- * Compared at 20 mm stroke for ø20 and ø25
- * Compared at 25 mm stroke for ø32 to ø80
- * Compared at 50 mm stroke for ø100

Guide rod: Max. 22 mm shorter

(Compared with the existing MLGPM)

Bore size	Guide rod	
	Dimension	Shortened dimension
ø32	15.5	22
ø40	9	22
ø50	16.5	18
ø63	11.5	18
ø80	8	10.5
ø100	10.5	10.5

* Compared at 25 mm stroke
For ø20 and ø25, there is no projection at 25 mm stroke.

Small auto switches or magnetic field-resistant auto switches can be directly mounted on two surfaces.



Four types of mounting

Top through-hole mounting

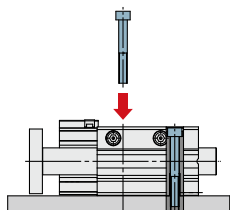

Bottom tapped mounting

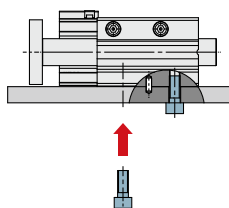

T-slot bottom mounting

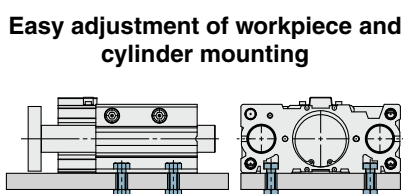

Bottom mounting

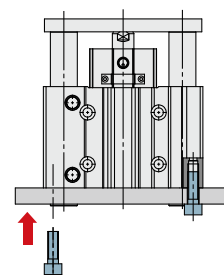

Positioning holes are available on three surfaces.

- Easy positioning
- Knock pin holes provided on each mounting surface

Positioning pin holes for workpiece on the mounting plate

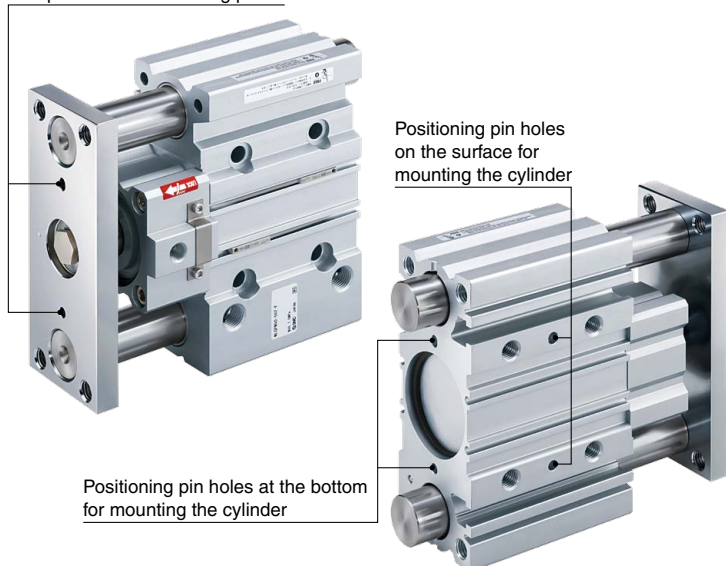

Piping is possible from two directions.

Top ported

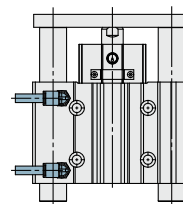

Side ported

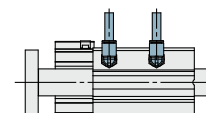

Two types of guide rod bearing

Slide bearing

Excellent wear resistance allows use with high loads.

Ball bushing bearing

Provides high precision and smooth operation

Series Variations

Series	Bearing	Locking direction	Bore size [mm]	Standard stroke [mm]														
				20	25	30	40	50	75	100	125	150	175	200	250	300	350	
 MLGP	Slide bearing	Extension locking	20	●		●	●	●	●	●	●	●	●	●	●	●	●	
			25	●		●	●	●	●	●	●	●	●	●	●	●	●	●
		32		●			●	●	●	●	●	●	●	●	●	●	●	●
		40		●			●	●	●	●	●	●	●	●	●	●	●	●
	Ball bushing bearing	Retraction locking	50		●			●	●	●	●	●	●	●	●	●	●	●
			63		●			●	●	●	●	●	●	●	●	●	●	●
		80		●			●	●	●	●	●	●	●	●	●	●	●	●
		100					●	●	●	●	●	●	●	●	●	●	●	●

CONTENTS

Compact Guide Cylinder with Lock *MLGP Series*

How to Order	p. 5
Specifications	p. 6
Weight	p. 7
Construction	
$\varnothing 20, \varnothing 25, \varnothing 32$	p. 8
$\varnothing 40$ to $\varnothing 100$	p. 9
Dimensions	
$\varnothing 20, \varnothing 25, \varnothing 32$	p. 10
$\varnothing 40, \varnothing 50, \varnothing 63$	p. 11
$\varnothing 80, \varnothing 100$	p. 12
Auto Switch Mounting	p. 13
Prior to Use	
Auto Switch Connections and Examples	p. 16
Model Selection	p. 17
Specific Product Precautions	p. 29



Compact Guide Cylinder with Lock

MLGP Series

ø20, ø25, ø32, ø40, ø50, ø63, ø80, ø100

How to Order

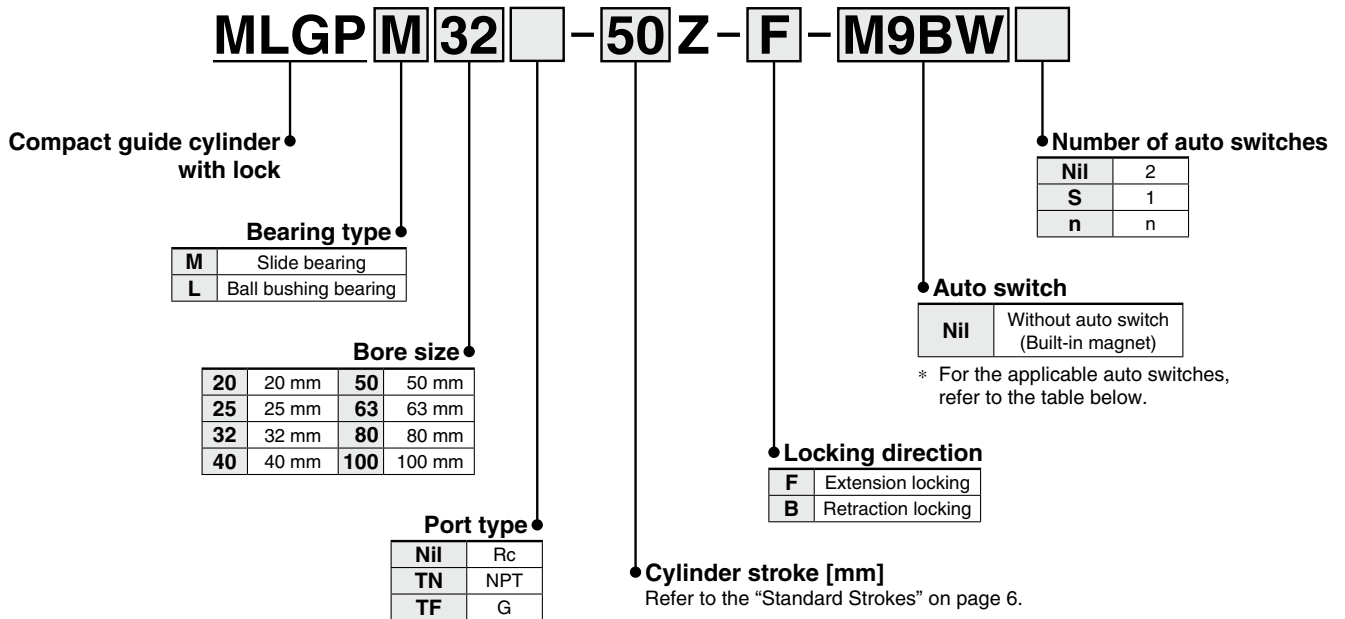

Applicable Auto Switches/Refer to the Web Catalog or Best Pneumatics Catalog for further information on auto switches.

Type	Special function	Electrical entry	Indicator/light	Wiring (Output)	Load voltage		Auto switch model		Lead wire length [m]				Pre-wired connector	Applicable load		
					DC	AC	Perpendicular	In-line	0.5 (Nil)	1 (M)	3 (L)	5 (Z)				
Solid state auto switch	—	Grommet	Yes	3-wire (NPN)	24 V	5 V, 12 V	—	M9NV	M9N	●	●	●	○	○	IC circuit	Relay, PLC
				3-wire (PNP)				M9PV	M9P	●	●	●	○	○		
	2-wire			12 V	M9BV	M9B	●	●	●	○	○	—				
	3-wire (NPN)			5 V, 12 V	M9NWV	M9NW	●	●	●	○	○	IC circuit				
	3-wire (PNP)			5 V, 12 V	M9PWV	M9PW	●	●	●	○	○	—				
	2-wire			12 V	M9BWV	M9BW	●	●	●	○	○	—				
	3-wire (NPN)			5 V, 12 V	M9NAV*1	M9NA*1	○	○	●	○	○	IC circuit				
	3-wire (PNP)			5 V, 12 V	M9PAV*1	M9PA*1	○	○	●	○	○	IC circuit				
	2-wire			12 V	M9BAV*1	M9BA*1	○	○	●	○	○	—				
	2-wire (Non-polar)			—	—	P3DWA*3	●	—	●	●	○	—				
Reed auto switch	—	Grommet	Yes	3-wire (NPN equivalent)	24 V	5 V	—	A96V	A96	●	—	●	—	—	IC circuit	—
				2-wire				100 V	A93V*2	A93	●	●	●	●	—	—
				2-wire	100 V or less	A90V	A90	●	—	●	—	—	—	IC circuit	PLC	

*1 Water-resistant type auto switches can be mounted on the above models, but SMC cannot guarantee water resistance.

Please contact SMC regarding water-resistant types with the above model numbers.

*2 The 1 m lead wire is only applicable to the D-A93.

*3 The D-P3DWA□ can be mounted on the bore sizes ø25 to ø100.

*4 The D-P4DW can be mounted on the bore sizes ø32 to ø100.

* Lead wire length symbols: 0.5 mNil (Example) M9NW
 1 mM (Example) M9NWM
 3 mL (Example) M9NWL
 5 mZ (Example) M9NwZ

* Solid state auto switches marked with "○" are produced upon receipt of order.

* Auto switches are shipped together, but not assembled.

Compact Guide Cylinder with Lock **MLGP Series**

Cylinder Specifications



Bore size [mm]	20	25	32	40	50	63	80	100
Action	Double acting							
Fluid	Air							
Proof pressure	1.5 MPa							
Maximum operating pressure	1.0 MPa							
Minimum operating pressure	0.2 MPa *1							
Ambient and fluid temperatures	-10 to 60°C (No freezing)							
Piston speed	50 to 400 mm/s							
Cushion	Rubber bumper on both ends							
Lubrication	Not required (Non-lube)							
Stroke length tolerance	+1.5 0 mm							
Port size (Rc, NPT, G)	1/8			1/4			3/8	

*1 When the unlocking air and cylinder operating air are not common, the minimum operating pressure is 0.15 MPa. (The minimum operating pressure for the cylinder alone is 0.15 MPa.)

Lock Specifications

Bore size [mm]	20	25	32	40	50	63	80	100
Lock operation	Spring locking (Exhaust locking)							
Unlocking pressure	0.2 MPa or more							
Lock starting pressure	0.05 MPa or less							
Locking direction	One direction (Extension locking, Retraction locking)							
Maximum operating pressure	1.0 MPa							
Unlocking port size (Rc, NPT, G)	M5 x 0.8			1/8			1/4	
Holding force (Max. static load) [N] *1	157	245	402	629	982	1559	2513	3927

*1 The holding force (max. static load) shows the maximum capability and does not show the normal holding capability. For selection of the cylinder, refer to the Model Selection (page 17) and Specific Product Precautions (page 29).

* Refer to the Specific Product Precautions (page 32) for manually unlocking and holding the unlocked state.

Standard Strokes

* When using with auto switches, refer to the Minimum Stroke for Auto Switch Mounting table on page 14.

Bore size [mm]	Standard stroke [mm]
20, 25	20, 30, 40, 50, 75, 100, 125, 150, 175, 200, 250, 300, 350
32 to 80	25, 50, 75, 100, 125, 150, 175, 200, 250, 300, 350
100	50, 75, 100, 125, 150, 175, 200, 250, 300, 350

Manufacture of Intermediate Strokes

Description	Spacer installation type Spacers are installed in the standard stroke cylinders. ø20 to 32: Stroke can be modified in 1 mm increments. ø40 to 100: Stroke can be modified in 5 mm increments.	
Part no.	Refer to the "How to Order" for the standard model numbers.	
Applicable stroke [mm]	ø20, ø25, ø32	1 to 349
	ø40 to ø80	5 to 345
	ø100	25 to 345
Example	Part no.: MLGPM20-39Z-F A 1 mm spacer is installed in MLGPM20-40Z-F. Dimension C is 77 mm.	

For details on cylinders with auto switches ⇨ pages 13 to 16

- Auto Switch Proper Mounting Position (Detection at stroke end) and Mounting Height
 - Minimum Stroke for Auto Switch Mounting
 - Operating Range
 - Auto Switch Mounting
 - Prior to Use
- Auto Switch Connections and Examples

Theoretical Output

Bore size [mm]	Rod size [mm]	Operating direction	Piston area [mm ²]	Operating pressure [MPa]									
				0.2	0.3	0.4	0.5	0.6	0.7	0.8	0.9	1.0	
20	10	OUT	314	63	94	126	157	188	220	251	283	314	
		IN	236	47	71	94	118	142	165	189	212	236	
25	12	OUT	491	98	147	196	246	295	344	393	442	491	
		IN	378	76	113	151	189	227	265	302	340	378	
32	16	OUT	804	161	241	322	402	482	563	643	724	804	
		IN	603	121	181	241	302	362	422	482	543	603	
40	16	OUT	1257	251	377	503	629	754	880	1006	1131	1257	
		IN	1056	211	317	422	528	634	739	845	950	1056	
50	20	OUT	1963	393	589	785	982	1178	1374	1570	1767	1963	
		IN	1649	330	495	660	825	990	1154	1319	1484	1649	
63	20	OUT	3117	623	935	1247	1559	1870	2182	2494	2805	3117	
		IN	2803	561	841	1121	1402	1682	1962	2242	2523	2803	
80	25	OUT	5027	1005	1508	2011	2514	3016	3519	4022	4524	5027	
		IN	4536	907	1361	1814	2268	2722	3175	3629	4082	4536	
100	30	OUT	7854	1571	2356	3142	3927	4712	5498	6283	7069	7854	
		IN	7147	1429	2144	2859	3574	4288	5003	5718	6432	7147	

* Theoretical output [N] = Pressure [MPa] x Piston area [mm²]

MLGP Series

Weight

Slide Bearing: MLGPM20 to 100

Bore size [mm]	Standard stroke [mm]													
	20	25	30	40	50	75	100	125	150	175	200	250	300	350
20	0.76	—	0.83	0.91	0.98	1.23	1.42	1.61	1.79	1.98	2.17	2.60	2.97	3.35
25	1.12	—	1.22	1.32	1.42	1.79	2.05	2.30	2.56	2.82	3.07	3.69	4.20	4.72
32	—	1.83	—	—	2.19	2.65	3.02	3.38	3.75	4.12	4.48	5.22	5.95	6.64
40	—	2.11	—	—	2.52	3.01	3.42	3.82	4.23	4.63	5.03	6.02	6.83	7.64
50	—	3.55	—	—	4.15	4.91	5.51	6.11	6.71	7.31	7.91	9.42	10.7	11.9
63	—	4.49	—	—	5.18	6.03	6.72	7.41	8.10	8.79	9.48	11.2	12.6	14.0
80	—	7.11	—	—	7.99	9.17	10.1	11.0	11.9	12.7	13.6	15.9	17.7	19.4
100	—	—	—	—	13.7	15.4	16.7	17.9	19.2	20.5	21.7	24.8	27.2	29.6

Ball Bushing Bearing: MLGPL20 to 100

Bore size [mm]	Standard stroke [mm]													
	20	25	30	40	50	75	100	125	150	175	200	250	300	350
20	0.75	—	0.82	0.94	1.01	1.16	1.32	1.53	1.69	1.85	2.01	2.36	2.68	3.00
25	1.11	—	1.20	1.37	1.45	1.66	1.88	2.14	2.36	2.57	2.78	3.26	3.68	4.11
32	—	1.73	—	—	2.03	2.45	2.75	3.14	3.43	3.73	4.02	4.71	5.30	5.85
40	—	2.00	—	—	2.34	2.80	3.13	3.56	3.89	4.22	4.56	5.32	5.98	6.65
50	—	3.31	—	—	3.82	4.53	5.04	5.66	6.17	6.67	7.18	8.35	9.36	10.4
63	—	4.24	—	—	4.84	5.65	6.24	6.95	7.55	8.14	8.74	10.1	11.3	12.5
80	—	6.76	—	—	7.81	9.04	9.79	10.6	11.3	12.1	12.8	14.7	16.2	17.7
100	—	—	—	—	13.4	15.1	16.2	17.3	18.4	19.5	19.7	23.1	25.2	27.2

Allowable Rotational Torque of Plate

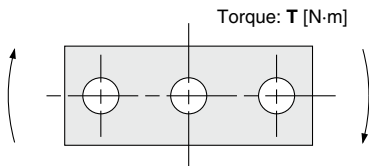

Non-rotating Accuracy of Plate

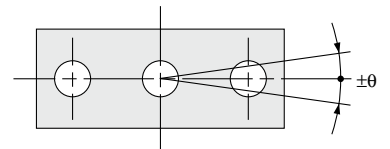

Bore size [mm]	Bearing type	Stroke													
		20	25	30	40	50	75	100	125	150	175	200	250	300	350
20	MLGPM	0.77	—	0.70	0.64	0.59	1.62	1.42	1.27	1.15	1.05	0.97	0.83	0.73	0.65
	MLGPL	0.75	—	0.68	1.49	1.41	1.24	1.11	1.29	1.18	1.08	1.00	0.86	0.76	0.67
25	MLGPM	1.24	—	1.13	1.04	0.97	2.49	2.20	1.98	1.79	1.64	1.51	1.30	1.15	1.02
	MLGPL	1.23	—	1.14	2.26	2.14	1.90	1.71	1.96	1.79	1.65	1.53	1.33	1.17	1.04
32	MLGPM	—	4.89	—	—	4.13	4.82	4.29	3.87	3.53	3.24	2.99	2.60	2.30	2.06
	MLGPL	—	4.22	—	—	3.64	4.07	3.67	5.37	4.97	4.62	4.31	3.80	3.39	3.06
40	MLGPM	—	5.29	—	—	4.49	5.25	4.68	4.23	3.86	3.54	3.28	2.85	2.52	2.26
	MLGPL	—	4.53	—	—	3.93	4.41	3.98	5.84	5.41	5.03	4.70	4.15	3.70	3.34
50	MLGPM	—	10.06	—	—	8.66	10.13	9.12	8.29	7.60	7.01	6.51	5.70	5.06	4.56
	MLGPL	—	6.40	—	—	5.57	7.76	7.04	9.75	9.05	8.43	7.88	6.96	6.22	5.60
63	MLGPM	—	11.13	—	—	9.60	11.27	10.15	9.24	8.48	7.83	7.28	6.37	5.67	5.11
	MLGPL	—	6.91	—	—	6.02	8.48	7.69	10.73	9.95	9.27	8.67	7.65	6.83	6.14
80	MLGPM	—	16.70	—	—	14.67	19.10	17.41	15.99	14.79	13.75	12.85	11.36	10.18	9.23
	MLGPL	—	9.44	—	—	16.88	17.92	16.51	15.28	14.20	13.24	12.37	10.89	9.66	8.62
100	MLGPM	—	—	—	—	26.17	30.70	28.23	26.12	24.31	22.73	21.35	19.03	17.17	15.64
	MLGPL	—	—	—	—	21.11	29.10	26.98	25.10	23.43	21.93	20.57	18.21	16.22	14.53

Bore size [mm]	Non-rotating accuracy θ	
	MLGPM	MLGPL
20	$\pm 0.06^\circ$	$\pm 0.04^\circ$
25	$\pm 0.06^\circ$	$\pm 0.04^\circ$
32	$\pm 0.05^\circ$	$\pm 0.03^\circ$
40	$\pm 0.05^\circ$	$\pm 0.03^\circ$
50	$\pm 0.04^\circ$	$\pm 0.03^\circ$
63	$\pm 0.04^\circ$	$\pm 0.03^\circ$
80	$\pm 0.03^\circ$	$\pm 0.03^\circ$
100	$\pm 0.03^\circ$	$\pm 0.03^\circ$

* For the non-rotating accuracy θ without load, use a value no more than the values in the table as a guide.

* Do not apply rotational force in a locked condition, as this will cause damage to the lock mechanism or decrease of the product life.

Construction: $\varnothing 20$, $\varnothing 25$, $\varnothing 32$

MLGPM series

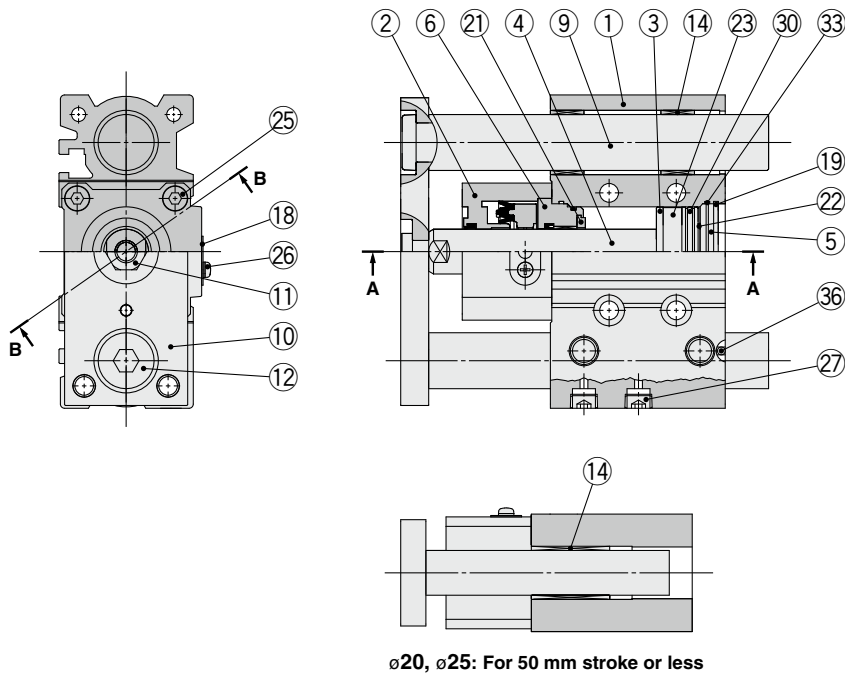

MLGPL series

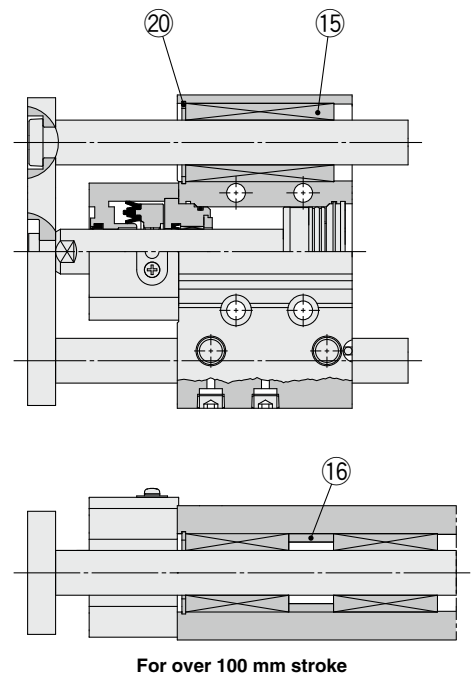

Extension locking (F type)

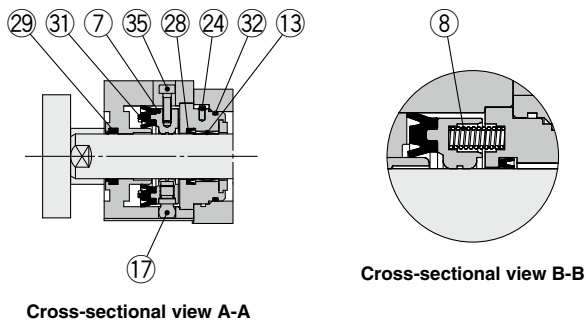

Retraction locking (B type)

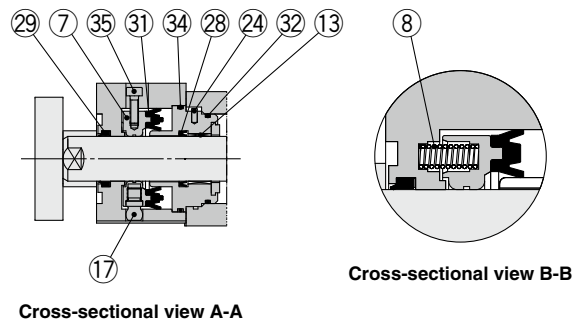

Component Parts

No.	Description	Material	Note
1	Body	Aluminum alloy	Hard anodized
2	Lock body	Aluminum alloy	Hard anodized
3	Piston	Aluminum alloy	
4	Piston rod	$\varnothing 20$ to $\varnothing 25$ $\varnothing 32$	Stainless steel Structural steel
			Hard chrome plating
5	Head cover	Aluminum alloy	Chromated
6	Intermediate collar	Aluminum alloy	Chromated
7	Lock ring	Tool steel	Heat treated
8	Brake spring	Steel wire	Zinc chromated
9	Guide rod	Structural steel	Hard chrome plating
10	Plate	Structural steel	Nickel plating
11	Plate mounting bolt	Structural steel	Nickel plating
12	Guide bolt	Structural steel	Nickel plating
13	Slide bearing	Bearing alloy	
14	Slide bearing	Bearing alloy	MLGPM type
15	Ball bushing	—	MLGPL type
16	Spacer	Aluminum alloy	
17	Pivot	Structural steel	Heat treated/Electroless nickel plating
18	Dust cover	Stainless steel	

Component Parts

No.	Description	Material	Note
19	Retaining ring	Tool steel	Phosphate coated
20	Retaining ring	Tool steel	Phosphate coated
21	Bumper A	Urethane	
22	Bumper B	Urethane	
23	Magnet	—	
24	Parallel pin	Stainless steel	
25	Hexagon socket head cap screw	Structural steel	Nickel plating
26	Dust cover holding bolt	Steel wire	Nickel plating
27	Hexagon socket head taper plug	Steel wire	Nickel plating
28	Rod seal	NBR	
29	Scraper	NBR	
30	Piston seal	NBR	
31	Lock ring seal	NBR	
32	Gasket A	NBR	
33	Gasket B	NBR	
34	Lock body gasket	NBR	
35	Unlocking bolt	Structural steel	Nickel plating
36	Steel ball	Special steel	

MLGP Series

Construction: $\phi 40$ to $\phi 100$

MLGPM series

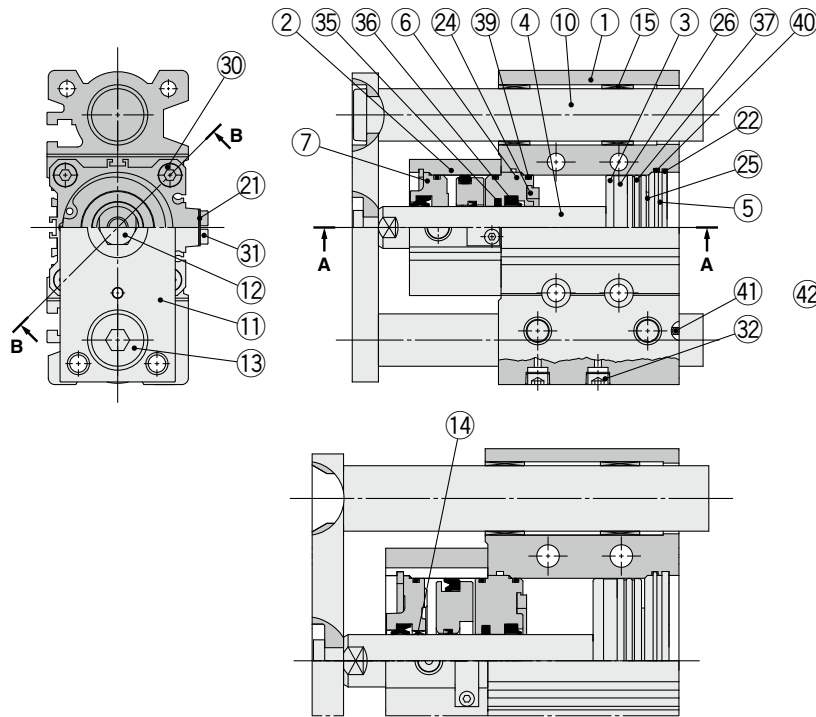

For $\phi 50$, $\phi 63$

MLGPL series

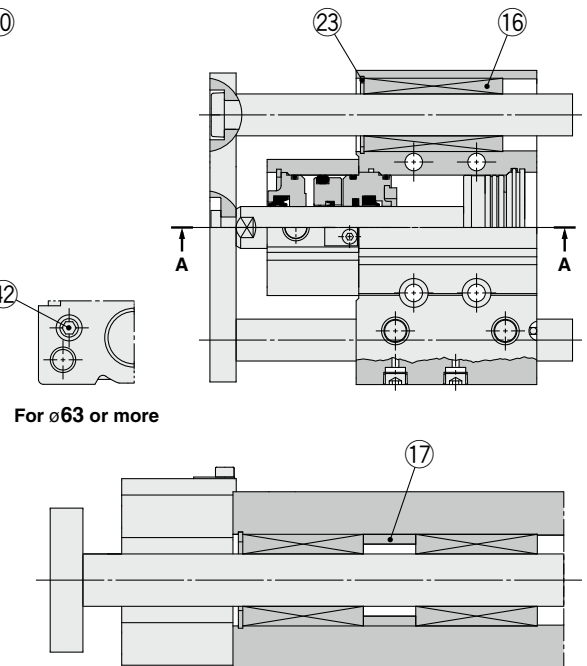

For $\phi 63$ or more

$\phi 40$ to $\phi 63$: For over 100 mm stroke
 $\phi 80$, $\phi 100$: For over 200 mm stroke

Extension locking (F type)

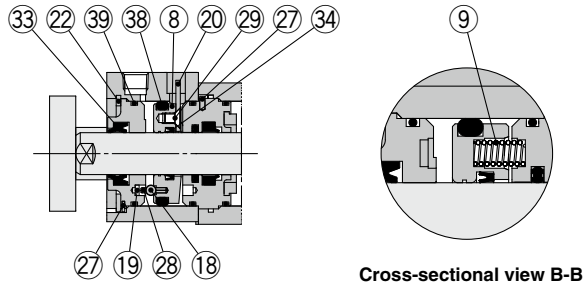

Cross-sectional view A-A

Cross-sectional view B-B

Retraction locking (B type)

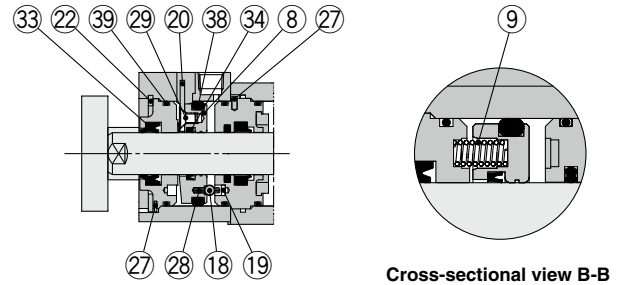

Cross-sectional view A-A

Cross-sectional view B-B

Component Parts

No.	Description	Material	Note
1	Body	Aluminum alloy	Hard anodized
2	Lock body	Aluminum alloy	Hard anodized
3	Piston	Aluminum alloy	
4	Piston rod	Structural steel	Hard chrome plating
5	Head cover	$\phi 40$	Aluminum alloy
		$\phi 50$ to $\phi 100$	Aluminum alloy casted
6	Intermediate collar	Aluminum alloy	Chromated
7	Collar	$\phi 40$	Aluminum alloy
		$\phi 50$ to $\phi 100$	Aluminum alloy casted
8	Lock ring	Tool steel	Heat treated
9	Brake spring	Steel wire	Zinc chromated
10	Guide rod	Structural steel	Hard chrome plating
11	Plate	Structural steel	Nickel plating
12	Plate mounting bolt	Structural steel	Nickel plating
13	Guide bolt	Structural steel	Nickel plating
14	Slide bearing	Bearing alloy	$\phi 50$ to $\phi 100$
15	Slide bearing	Bearing alloy	MLGPM type
16	Ball bushing	—	MLGPL type
17	Spacer	Aluminum alloy	
18	Pivot pin	Structural steel	Heat treated/Zinc chromated
19	Pivot key	Structural steel	Heat treated/Zinc chromated
20	Lever	Stainless steel	
21	Dust cover	$\phi 40$	Steel strip
		$\phi 50$ to $\phi 100$	Stainless steel

Component Parts

No.	Description	Material	Note
22	Retaining ring	Tool steel	Phosphate coated
23	Retaining ring	Tool steel	Phosphate coated
24	Bumper A	Urethane	
25	Bumper B	Urethane	
26	Magnet	—	
27	Parallel pin	Stainless steel	
28	Spring pin	Tool steel	
29	Hexagon socket flat countersunk head cap screw	Structural steel	Nickel plating
30	Hexagon socket head cap screw	Structural steel	Nickel plating
31	Dust cover holding bolt	Steel wire	Nickel plating
32	Hexagon socket head taper plug	Steel wire	Nickel plating
33	Rod seal A	NBR	
34	Rod seal B	NBR	
35	Rod seal C	NBR	
36	Scraper	NBR	
37	Piston seal	NBR	
38	Brake piston seal	NBR	
39	Gasket A	NBR	
40	Gasket B	NBR	
41	Steel ball	Special steel	$\phi 40$ to $\phi 50$
42	Plug	Steel wire	$\phi 63$ to $\phi 100$, Nickel plating

Compact Guide Cylinder with Lock *MLGP Series*

Dimensions: $\phi 20$, $\phi 25$, $\phi 32$

MLGPM/MLGPL

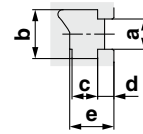
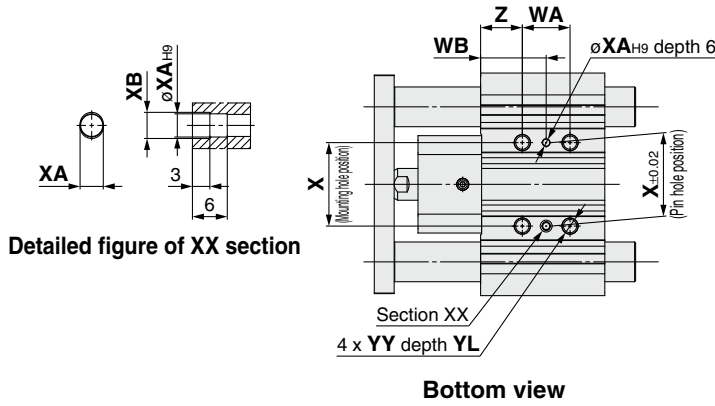

T-slot dimensions

Bore size	a	b	c	d	e
20	5.4	8.4	4.5	2.8	7.8
25	5.4	8.4	4.5	3	8.2
32	6.5	10.5	5.5	3.5	9.5

[mm]

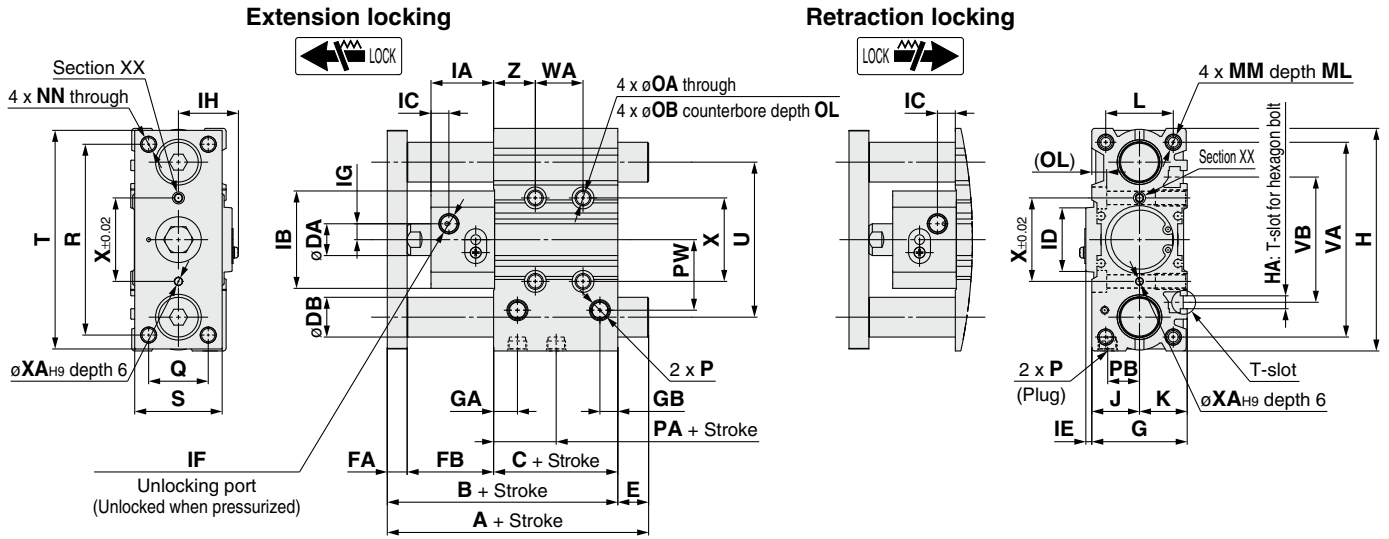

Common Dimensions: MLGPM/MLGPL

Bore size	Standard stroke	B	C	DA	FA	FB	G	GA	GB	H	HA	IA	IB	IC						IF			
														Extension locking			Retraction locking			ID	IE	Rc, NPT	G
														Rc, NPT	G	G	Rc, NPT	G					
20	20, 30, 40, 50, 75, 100, 125, 150	79.5	37	10	8	34.5	36	11.5	9	83	M5	26.5	36	9.5	9.5	6	6	—	—	M5 x 0.8	M5 x 0.8		
25	175, 200, 250, 300, 350	84	37.5	12	9	37.5	42	11.5	10	93	M5	30.5	40	10	10	7.5	7.5	—	—	M5 x 0.8	M5 x 0.8		
32	25, 50, 75, 100, 125, 150, 175, 200, 250, 300, 350	91	37.5	16	10	43.5	48	12	9	112	M6	31.5	49	9	8	9	4.5	32	3	1/8	M5 x 0.8		

Bore size	IG	IH	J	K	L	MM	ML	NN	OA	OB	OL	P			PA	PB	PW	Q	R	S	T	U	VA	VB
												Nil	TN	TF										
												Rc1/8	NPT1/8	G1/8										
20	6.5	21.2	18	18	24	M5 x 0.8	13	M5 x 0.8	5.4	9.5	5.5	Rc1/8	NPT1/8	G1/8	13.5	10.5	25	18	70	30	81	54	72	44
25	7	23.2	21	21	30	M6 x 1	15	M6 x 1	5.4	9.5	5.5	Rc1/8	NPT1/8	G1/8	12.5	13.5	30	26	78	38	91	64	82	50
32	8	30.2	24	24	34	M8 x 1.25	20	M8 x 1.25	6.7	11	7.5	Rc1/8	NPT1/8	G1/8	6.5	16	35.5	30	96	44	110	78	98	63

Bore size	WA							WB							X	XA	XB	YY	YL	Z
	25 st or less	30 st or less	Over 25 st or less	Over 30 st or less	Over 100 st or less	Over 200 st or less	Over 300 st or less	25 st or less	30 st or less	Over 25 st or less	Over 30 st or less	Over 100 st or less	Over 200 st or less	Over 300 st or less						
20	—	24	—	44	120	200	300	—	29	—	39	77	117	167	28	3	3.5	M6 x 1	12	17
25	—	24	—	44	120	200	300	—	29	—	39	77	117	167	34	4	4.5	M6 x 1	12	17
32	24	—	48	—	124	200	300	33	—	45	—	83	121	171	42	4	4.5	M8 x 1.25	16	21

A, DB, E Dimensions: MLGPM (Slide Bearing) [mm]

Bore size	A			DB	E		
	50 st or less	Over 50 st or less	Over 200 st		50 st or less	Over 50 st or less	Over 200 st
20	79.5	104	136.5	12	0	24.5	57
25	84	108	140	16	0	24	56
32	106.5	125	161	20	15.5	34	70

A, DB, E Dimensions: MLGPL (Ball Bushing Bearing) [mm]

Bore size	A						DB	E					
	30 st or less	50 st or less	Over 30 st or less	Over 50 st or less	Over 100 st or less	Over 200 st or less		30 st or less	50 st or less	Over 30 st or less	Over 50 st or less	Over 100 st or less	Over 200 st or less
20	85.5	—	102.5	—	126.5	144	10	6	—	23	—	47	64.5
25	96	—	112	—	131	148	13	12	—	28	—	47	64
32	—	111	—	128	148	170	16	—	20	—	37	57	79

MLGP Series

Dimensions: $\varnothing 40$, $\varnothing 50$, $\varnothing 63$

MLGPM/MLGPL

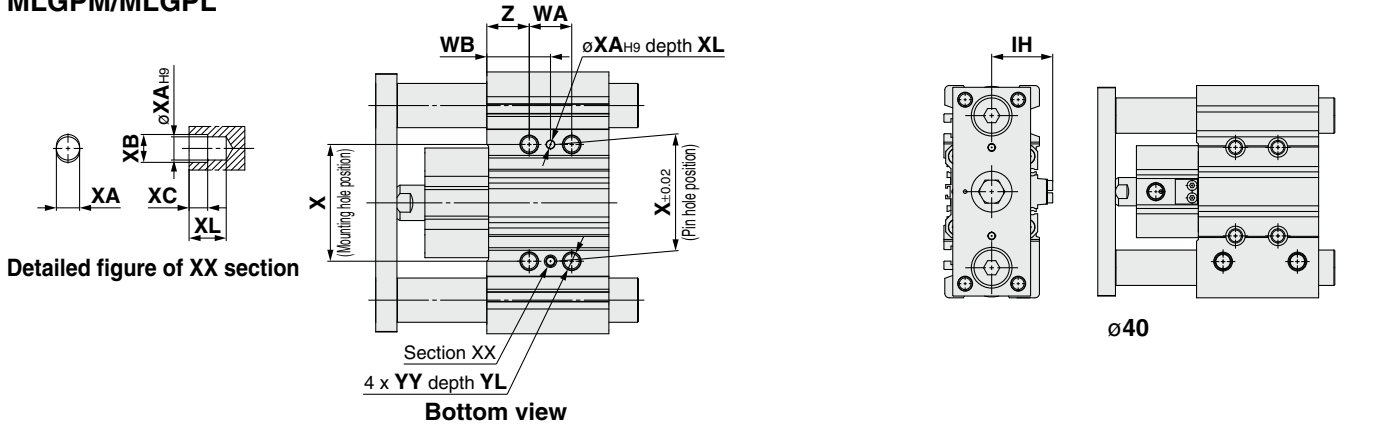

Detailed figure of XX section

Section XX
4 x YY depth YL

Bottom view

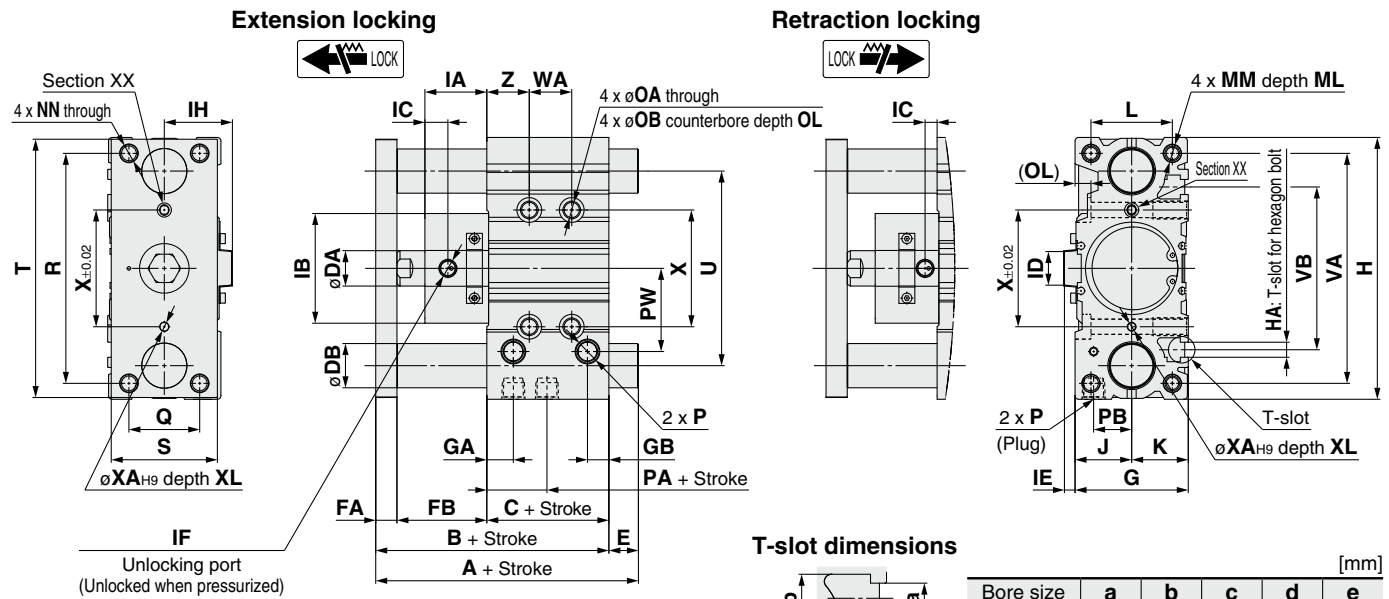

Extension locking

Retraction locking

T-slot dimensions

	[mm]				
Bore size	a	b	c	d	e
40	6.5	10.5	5.5	4	11
50	8.5	13.5	7.5	4.5	13.5
63	11	17.8	10	7	18.5

Common Dimensions: MLGPM/MLGPL

Bore size	Standard stroke	B	C	DA	FA	FB	G	GA	GB	H	HA	IA	IB	IC				ID	IE	IF	
														Extension locking		Retraction locking				Rc, NPT	G
														Rc, NPT	G	Rc, NPT	G				
40	25, 50, 75, 100, 125	100	44	16	10	46	54	15	12	120	M6	34	52	11	13.8	6.5	4.5	14	4	1/8	M5 x 0.8
50	150, 175, 200, 250	107	44	20	12	51	64	15	12	148	M8	35	62	13	15	6.8	4.8	19	6	1/8	M5 x 0.8
63	300, 350	115	49	20	12	54	78	15.5	13.5	162	M10	38	86	16.5	16.5	7.5	6.5	19	6	1/8	1/8

Bore size	IH	J	K	L	MM	ML	NN	OA	OB	OL	P			PA	PB	PW	Q	R	S	T	U	VA	VB
											Nil	TN	TF										
											Rc1/8	NPT1/8	G1/8										
40	34.5	27	27	40	M8 x 1.25	20	M8 x 1.25	6.7	11	7.5	Rc1/8	NPT1/8	G1/8	13	18	39.5	30	104	44	118	86	106	72
50	38.5	32	32	46	M10 x 1.5	22	M10 x 1.5	8.6	14	9	Rc1/4	NPT1/4	G1/4	9	21.5	47	40	130	60	146	110	130	92
63	45.5	39	39	58	M10 x 1.5	22	M10 x 1.5	8.6	—	9	Rc1/4	NPT1/4	G1/4	13	28	58	50	130	70	158	124	142	110

Bore size	WA					WB					X	XA	XB	XC	XL	YY	YL	Z
	25 st or less	Over 25 st or less	Over 100 st or less	Over 200 st or less	Over 300 st or less	25 st or less	Over 25 st or less	Over 100 st or less	Over 200 st or less	Over 300 st or less								
40	24	48	124	200	300	34	46	84	122	172	50	4	4.5	3	6	M8 x 1.25	16	22
50	24	48	124	200	300	36	48	86	124	174	66	5	6	4	8	M10 x 1.5	20	24
63	28	52	128	200	300	38	50	88	124	174	80	5	6	4	8	M10 x 1.5	20	24

A, DB, E Dimensions: MLGPM (Slide Bearing) [mm]

Bore size	A			DB	E		
	50 st or less	Over 50 st or less	Over 200 st or less		50 st or less	Over 50 st or less	Over 200 st or less
	40	109	127.5		163.5	20	9
50	123.5	144.5	185.5	25	16.5	37.5	78.5
63	126.5	147.5	188.5	25	11.5	32.5	73.5

A, DB, E Dimensions: MLGPL (Ball Bushing Bearing) [mm]

Bore size	A				DB	E			
	50 st or less	Over 50 st or less	Over 100 st or less	Over 200 st or less		50 st or less	Over 50 st or less	Over 100 st or less	Over 200 st or less
	40	113.5	130.5	150.5		172.5	16	13.5	30.5
50	126.5	147.5	167.5	194.5	20	19.5	40.5	60.5	87.5
63	129.5	150.5	170.5	197.5	20	14.5	35.5	55.5	82.5

Dimensions: $\varnothing 80, \varnothing 100$

MLGPM/MLGPL

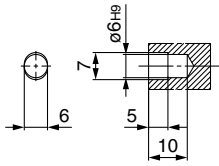

Detailed figure of XX section

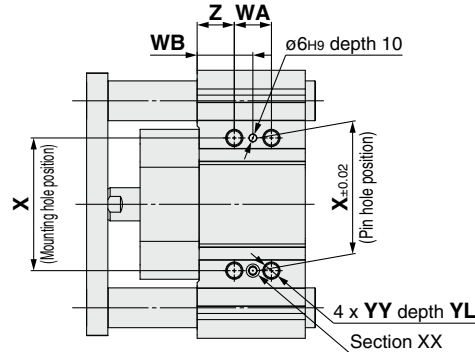

Bottom view

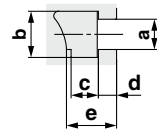

T-slot dimensions

Bore size	a	b	c	d	e
80	13.3	20.3	12	8	22.5
100	15.3	23.3	13.5	10	30

Extension locking



Retraction locking

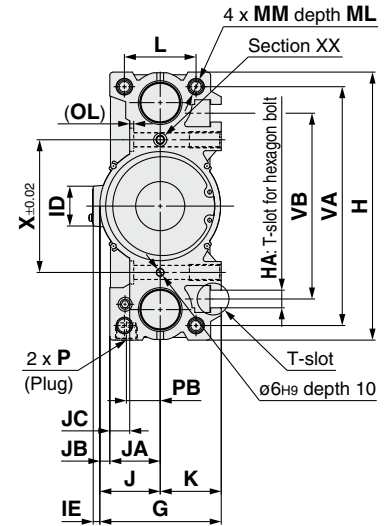
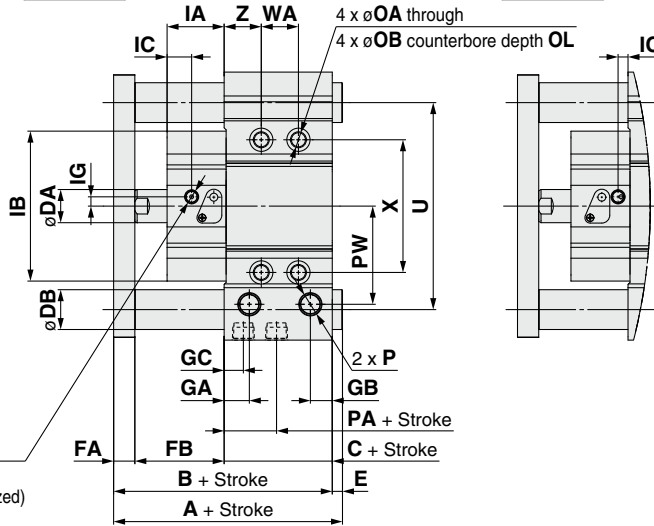
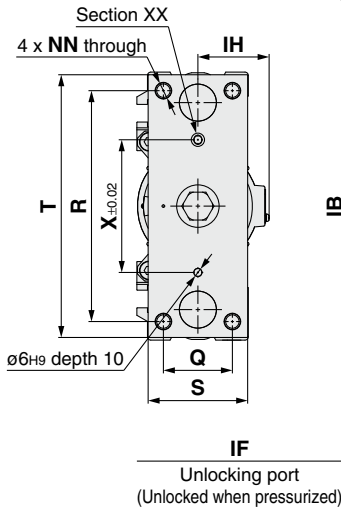

Common Dimensions: MLGPM/MLGPL

Bore size	Standard stroke																IC				IF	
	B	C	DA	FA	FB	G	GA	GB	GC	H	HA	IA	IB	Extension locking		Retraction locking		ID	IE			
	Rc, NPT	G	Rc, NPT	G	Rc, NPT	G	Rc, NPT	G	Rc, NPT	G	Rc, NPT	G	Rc, NPT	G	Rc, NPT	G	Rc, NPT	G	Rc, NPT	G		
80	25, 50, 75, 100, 125, 150, 175, 200, 250, 300, 350	139.5	56.5	25	16	67	91.5	19	16.5	14.5	202	M12	43	113	18.5	18.5	7.5	7.5	30	5	1/8	1/8
100	50, 75, 100, 125, 150, 175, 200, 250, 300, 350	167.5	66	30	19	82.5	111.5	22.5	20.5	18	240	M14	51.5	137	23	23	11	8	50	5.5	1/4	1/8

Bore size	IG	IH	J	JA	JB	JC	K	L	MM	ML	NN	OA	OB	OL	P			PA	PB	PW	Q	R	S	T	U	VA	VB
	Nil			TN	TF	PA	PB	PW	Q	R	S	T	U	VA	VB												
	80	7	53.7	45.5	38	7.5	15	46	54	M12 x 1.75	25	M12 x 1.75	10.6	17.5	3	Rc3/8	NPT3/8	G3/8	14.5	25.5	74	52	174	75	198	156	180
100	15	64.2	55.5	45	10.5	10	56	62	M14 x 2	31	M14 x 2	12.5	20	8	Rc3/8	NPT3/8	G3/8	17.5	32.5	89	64	210	90	236	188	210	166

Bore size	WA							WB							X	YY	YL	Z	
	25 st or less	50 st or less	Over 25 st 100 st or less	Over 50 st 100 st or less	Over 100 st 200 st or less	Over 200 st 300 st or less	Over 300 st	25 st or less	50 st or less	Over 25 st 100 st or less	Over 50 st 100 st or less	Over 100 st 200 st or less	Over 200 st 300 st or less	Over 300 st					
	80	28	—	52	—	128	200	300	42	—	54	—	92	128					178
100	—	50	—	72	124	200	300	—	60	—	71	97	135	185	124	M14 x 2	28	35	

A, DB, E Dimensions: MLGPM (Slide Bearing)

Bore size	A			DB	E		
	50 st or less	Over 50 st 200 st or less	Over 200 st		50 st or less	Over 50 st 200 st or less	Over 200 st
	80	147.5	174.5		223.5	30	8
100	178	203	242	36	10.5	35.5	74.5

A, DB, E Dimensions: MLGPL (Ball Bushing Bearing)

Bore size	A				DB	E			
	25 st or less	Over 25 st 50 st or less	Over 50 st 200 st or less	Over 200 st		25 st or less	Over 25 st 50 st or less	Over 50 st 200 st or less	Over 200 st
	80	147.5	171.5	201.5		234.5	25	8	32
100	—	197	230	253	30	—	29.5	62.5	85.5

MLGP Series Auto Switch Mounting

Auto Switch Proper Mounting Position (Detection at stroke end) and Mounting Height

D-M9□/M9□V
D-M9□W/M9□WV
D-M9□A/M9□AV
D-A9□/A9□V

ø20 to ø100

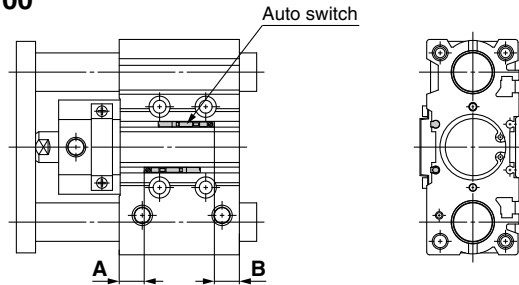

D-P3DWA (* Cannot be mounted on bore size ø20)
ø25 to ø63

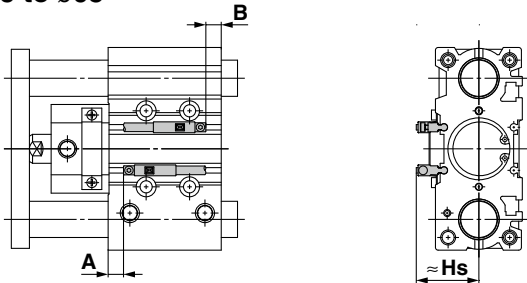

ø80, ø100

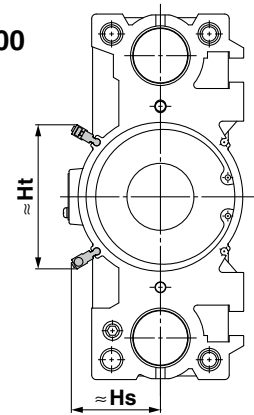

D-P4DW (* Cannot be mounted on bore size ø25 or less)
ø32 to ø63

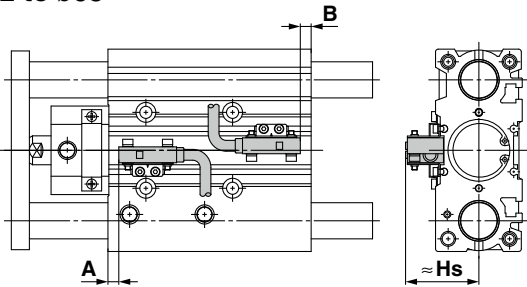

ø80, ø100

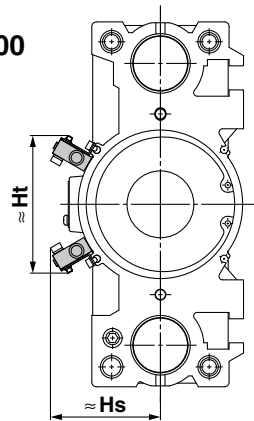

Auto Switch Proper Mounting Position [mm]

Bore size	Auto switch model		D-M9□ D-M9□V D-M9□W D-M9□WV D-M9□A D-M9□AV		D-A9□ D-A9□V		D-P3DWA		D-P4DW *1	
	A	B	A	B	A	B	A	B	A	B
	20	12.5	12.5	8.5	8.5	—	—	—	—	—
25	11.5	14	7.5	10	7	9.5	—	—	—	—
32	12.5	13	8.5	9	8	8.5	5.5	6	—	—
40	15.5	16.5	11.5	12.5	11	12	8.5	9.5	—	—
50	14.5	17	10.5	13	10	12.5	7.5	10	—	—
63	16.5	20	12.5	16	12	15.5	9.5	13	—	—
80	18	26	14	22	13.5	21.5	11	19	—	—
100	21.5	32.5	17.5	28.5	17	28	14.5	25.5	—	—

*1 The auto switch mounting bracket BMG7-032 is used.

* Adjust the auto switch after confirming the operating conditions in the actual setting.

Auto Switch Mounting Height [mm]

Bore size	Auto switch model		D-M9□V D-M9□WV D-M9□AV		D-A9□V		D-P3DWA		D-P4DW *1	
	Hs	Ht	Hs	Ht	Hs	Ht	Hs	Ht		
	20	24.5	—	22	—	—	—	—	—	
25	26	—	24	—	32.5	—	—	—		
32	29	—	26.5	—	35	—	40	—		
40	33	—	30.5	—	39	—	44	—		
50	38.5	—	36	—	44.5	—	49.5	—		
63	45.5	—	43	—	51.5	—	56.5	—		
80	45	74	43	71.5	50	80.5	61	74		
100	55	85.5	53	83	60	92	71.5	86		

*1 The auto switch mounting bracket BMG7-032 is used.

Minimum Stroke for Auto Switch Mounting

		[mm]							
Auto switch model	Number of auto switches	ø20	ø25	ø32	ø40	ø50	ø63	ø80	ø100
D-M9□	1	5*1		5					
	2			10					
D-M9□V	1			5					
	2			5					
D-M9□W	1			5*2					
	2			10					
D-M9□WV D-M9□AV	1			5*2					
	2			10					
D-M9□A	1			5*2					
	2			10*2					
D-A9□	1	5*1		5					
	2	10*1		10					
D-A9□V	1			5					
	2			10					
D-P3DWA	1	—			15*2				
	2	—			15*2				
D-P4DW	1	—		5*2					
	2 (Different surfaces)	—		10*2					
	2 (Same surface)	—		75				10	

*1 Confirm that it is possible to secure the minimum bending radius of 10 mm of the auto switch lead wire before use.

*2 Confirm that it is possible to securely set the auto switch(es) within the range of indicator green light ON range before use.

For the in-line entry type, also consider *1 shown above.

Operating Range

		[mm]							
Auto switch model	Bore size								
	20	25	32	40	50	63	80	100	
D-M9□/M9□V D-M9□W/M9□WV D-M9□A/M9□AV	5	5	6	6	6	6.5	6	7	
D-A9□/A9□V	9	9	9.5	9.5	9.5	11	10.5	10.5	
D-P3DWA	—	5.5	6.5	6	6	6.5	6	7	
D-P4DW	—	—	5	4	4	5	4	4	

* Values which include hysteresis are for reference purposes only. They are not a guarantee (assuming approximately ±30% dispersion) and may change substantially depending on the ambient environment.

Auto Switch Mounting

Applicable auto switches	D-M9□/M9□V D-M9□W/M9□WV D-M9□A/M9□AV D-A9□/A9□V	D-P3DWA						
Bore size [mm]	ø20 to ø100	ø25 to ø100						
Auto switch mounting bracket part no.	No mounting bracket required as the auto switch is directly mounted.							
Auto switch tightening torque	<table border="1"> <thead> <tr> <th>Auto switch model</th> <th>Tightening torque [N·m]</th> </tr> </thead> <tbody> <tr> <td>D-M9□(V) D-M9□W(V) D-M9□A(V)</td> <td>0.05 to 0.15</td> </tr> <tr> <td>D-A9□(V)</td> <td>0.10 to 0.20</td> </tr> </tbody> </table>	Auto switch model	Tightening torque [N·m]	D-M9□(V) D-M9□W(V) D-M9□A(V)	0.05 to 0.15	D-A9□(V)	0.10 to 0.20	0.2 to 0.3 N·m
Auto switch model	Tightening torque [N·m]							
D-M9□(V) D-M9□W(V) D-M9□A(V)	0.05 to 0.15							
D-A9□(V)	0.10 to 0.20							

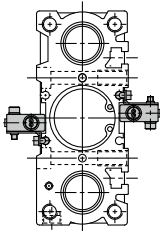
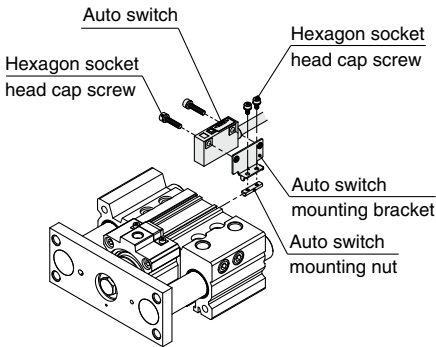
Applicable auto switches	D-P4DW
Bore size [mm]	ø32 to ø100
Auto switch mounting bracket part no.	BMG7-032
Auto switch mounting bracket/ Quantity	<ul style="list-style-type: none"> • Auto switch mounting bracket x 1 pc. • Auto switch mounting nut x 1 pc. • Hexagon socket head cap screw x 2 pcs. • Hexagon socket head cap screw x 2 pcs. (With spring washer x 2 pcs.)
Auto switch mounting surface	
Mounting of auto switch	<ol style="list-style-type: none"> 1. Attach the auto switch to the auto switch mounting bracket with the hexagon socket head cap screw (M3 x 14 L). The tightening torque for the M3 hexagon socket head cap screw is 0.5 to 0.8 N·m. 2. Fix the auto switch mounting nut and the auto switch mounting bracket temporarily by tightening the hexagon socket head cap screw (M2.5 x 5 L). 3. Insert the temporarily fixed auto switch mounting bracket into the auto switch mounting groove, and slide the auto switch through the auto switch mounting groove. 4. Check the detecting position of the auto switch and fix the auto switch firmly with the hexagon socket head cap screw (M2.5 x 5 L). The tightening torque for the M2.5 hexagon socket head cap screw is 0.2 to 0.3 N·m. 5. If the detecting position is changed, go back to step 3. 

* Auto switch mounting brackets and auto switches are enclosed with the cylinder for shipment.
For an environment that needs the water-resistant auto switch, select the D-M9□A(V) type.

Prior to Use

Auto Switch Connections and Examples

Sink Input Specifications

3-wire, NPN

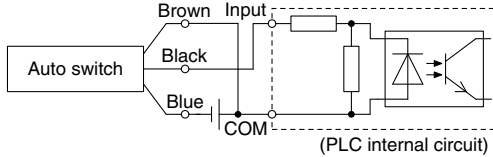

2-wire

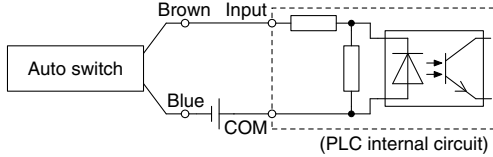

Source Input Specifications

3-wire, PNP

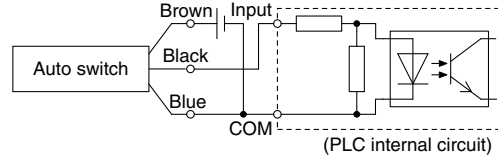

2-wire

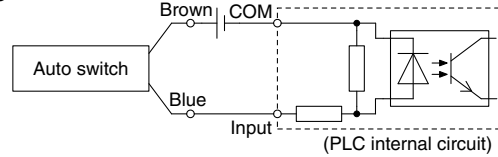

Connect according to the applicable PLC input specifications, as the connection method will vary depending on the PLC input specifications.

Examples of AND (Series) and OR (Parallel) Connections

* When using solid state auto switches, ensure the application is set up so the signals for the first 50 ms are invalid. Depending on the operating environment, the product may not operate properly.

3-wire AND connection for NPN output (Using relays)

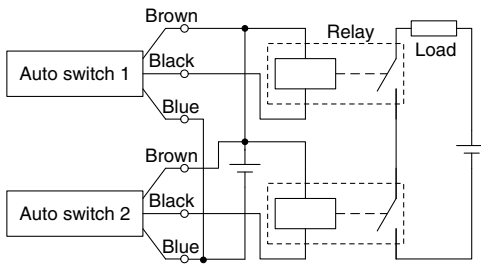

(Performed with auto switches only)

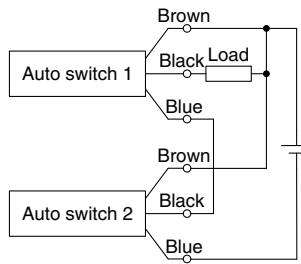

3-wire OR connection for NPN output

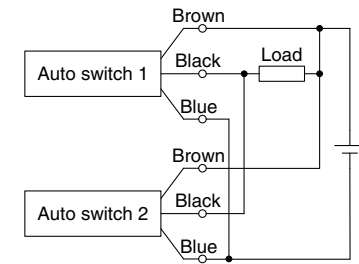

3-wire AND connection for PNP output (Using relays)

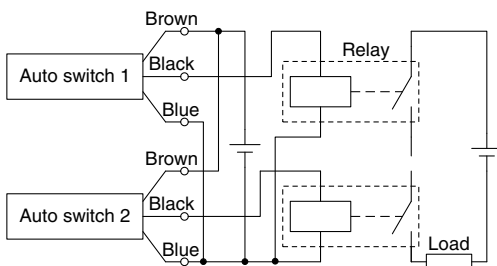

(Performed with auto switches only)

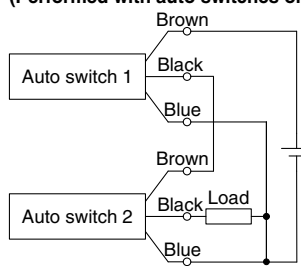

3-wire OR connection for PNP output

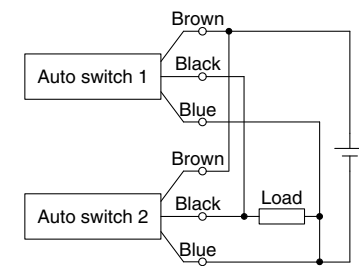

2-wire AND connection

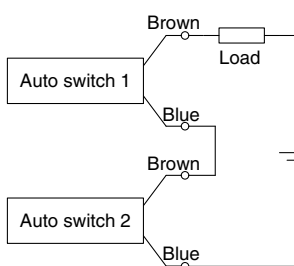

When two auto switches are connected in series, a load may malfunction because the load voltage will decline when in the ON state. The indicator lights will light up when both of the auto switches are in the ON state. Auto switches with a load voltage less than 20 V cannot be used.

$$\begin{aligned} \text{Load voltage at ON} &= \text{Power supply voltage} - \\ &\quad \text{Residual voltage} \times 2 \text{ pcs.} \\ &= 24 \text{ V} - 4 \text{ V} \times 2 \text{ pcs.} \\ &= 16 \text{ V} \end{aligned}$$

Example: Power supply is 24 VDC
Internal voltage drop in auto switch is 4 V.

2-wire OR connection

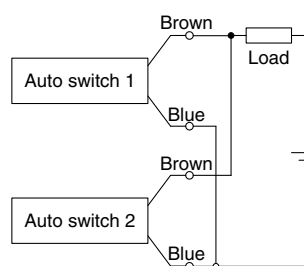

(Solid state)
When two auto switches are connected in parallel, malfunction may occur because the load voltage will increase when in the OFF state.

(Reed)
Because there is no current leakage, the load voltage will not increase when turned OFF. However, depending on the number of auto switches in the ON state, the indicator lights may sometimes grow dim or not light up, due to the dispersion and reduction of the current flowing to the auto switches.

$$\begin{aligned} \text{Load voltage at OFF} &= \text{Leakage current} \times 2 \text{ pcs.} \times \\ &\quad \text{Load impedance} \\ &= 1 \text{ mA} \times 2 \text{ pcs.} \times 3 \text{ k}\Omega \\ &= 6 \text{ V} \end{aligned}$$

Example: Load impedance is 3 k Ω .
Leakage current from auto switch is 1 mA.

MLGP Series Model Selection

Precautions on Model Selection

⚠ Caution

1. In order that the originally selected maximum speed shall be not exceeded, be certain to use a speed controller to adjust the total movement distance of the load so that movement takes place in no less than the applicable movement time.
2. For an intermediate stroke product with spacers installed, select using the base model stroke.

Step 1 Find the maximum load speed V.

The maximum load speed V [mm/s] is approximately equal to $V_1 \times 1.4 \dots(1)$

V_1 : Average load speed [mm/s]

$$V_1 = st/t$$

st: Load transfer distance [mm]

t: Load transfer time [s]

Step 2 Find the bore size.

1. For vertical mounting

- (1) From Table 1, find applicable selection graphs based on the maximum load speed "V", mounting orientation, and bearing type.
- (2) From the graphs chosen in (1), select the appropriate graph based on the stroke, and then find the intersecting point of the load mass "m" and eccentric distance "L₁".
- (3) Compare the intersecting point with the line chart for the operating pressure "P". Select the bore size from the line chart above the intersecting point.

2. For horizontal mounting

- (1) From Table 1, find applicable selection graphs based on the maximum load speed "V" and bearing type.
- (2) From the graphs chosen in (1), select the appropriate graph based on the distance "L₂" between the plate and load center of gravity, then find the intersecting point of the load mass "m" and stroke.
- (3) Compare the intersecting point with the line chart. Select the bore size from the line chart above the intersecting point.

Selection Conditions/Table 1

Mounting orientation	Vertical				Horizontal	
	Upward		Downward		Horizontal	
Maximum load speed V	50 to 200 mm/s	201 to 400 mm/s	50 to 200 mm/s	201 to 400 mm/s	50 to 200 mm/s	201 to 400 mm/s
Graph (Slide bearing type)	1, 2	3, 4	13, 14	15, 16	25, 26	27, 28
Graph (Ball bushing bearing type)	5 to 8	9 to 12	17 to 20	21 to 24	29, 30	31, 32

· When the maximum speed exceeds 200 mm/s, the allowable load mass is determined by multiplying the value shown in the graph at 400 mm/s by the coefficient listed in the table below.

Max. speed	Up to 300 mm/s	Up to 400 mm/s
Coefficient	1.7	1

Selection Example 1 (Vertical Upward Mounting)

Selection conditions

Mounting: Vertical upward
 Bearing type: Ball bushing bearing
 Stroke: 50 mm
 Load transfer time t : 0.5 s
 Load mass m : 15 kg
 Eccentric distance L_1 : 50 mm
 Operating pressure P : 0.5 MPa

Step 1: Find the maximum load speed "V" from formula (1).

Based on the stroke (load transfer distance) of 50 mm and load transfer time of 0.5 s, the maximum load speed V is approximately equal to $50/0.5 \times 1.4$, which is approximately 140 mm/s.

Step 2: Based on the maximum load speed found in Step 1, mounting orientation, and guide type, graphs 5 to 8 are selected. Then, based on the 50 mm stroke, graph 7 is selected from the group. Find the intersecting point of the load mass of 15 kg and the eccentric distance of 50 mm. Since the operating pressure is 0.5 MPa, the bore size of $\phi 80$ mm, model MLGPL80-50Z-B, is selected.

7 50 Stroke or Less $V = 200$ mm/s

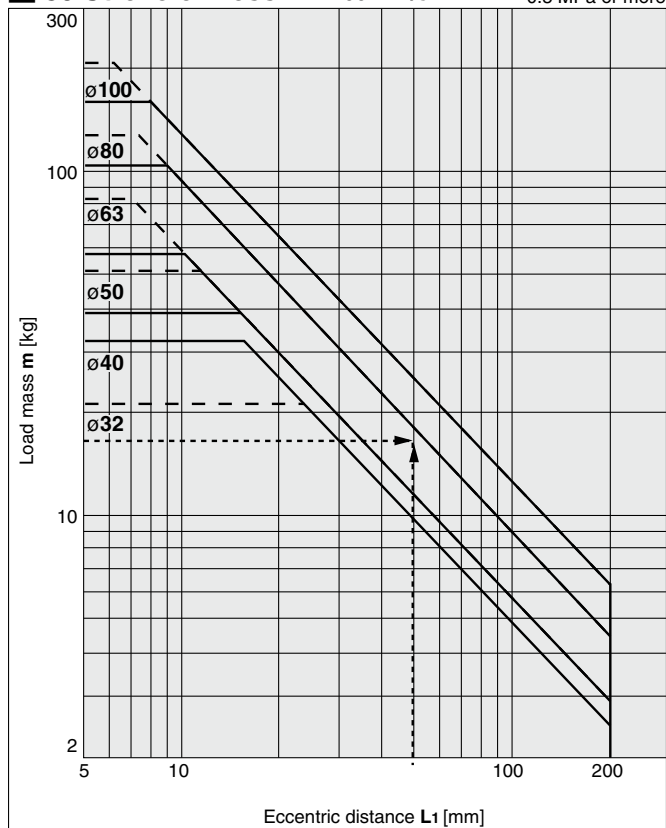

Selection Example 2 (Horizontal Mounting)

Selection conditions

Mounting: Horizontal
 Bearing type: Slide bearing
 Stroke: 100 mm
 Load transfer time t : 0.35 s
 Load mass m : 6 kg
 Eccentric distance between the plate and load center of gravity L_2 : 50 mm
 Operating pressure P : 0.4 MPa

Step 1: Find the maximum load speed "V" from formula (1).

Based on the stroke (load transfer distance) of 100 mm and load transfer time of 0.35 s, the maximum load speed V is approximately equal to $100/0.35 \times 1.4$, which is approximately 400 mm/s.

Step 2: Based on the maximum load speed found in Step 1, mounting orientation, and guide type, graphs 27 and 28 are selected. Then, based on the distance of 50 mm between the plate and load center of gravity, graph 27 is selected from the two graphs. Find the intersecting point of the load mass of 6 kg and the 100 mm stroke. The bore size of $\phi 40$ mm, model MLGPM40-50Z-□, is selected.

27 $L_2 = 50$ mm $V = 400$ mm/s Horizontal Mounting

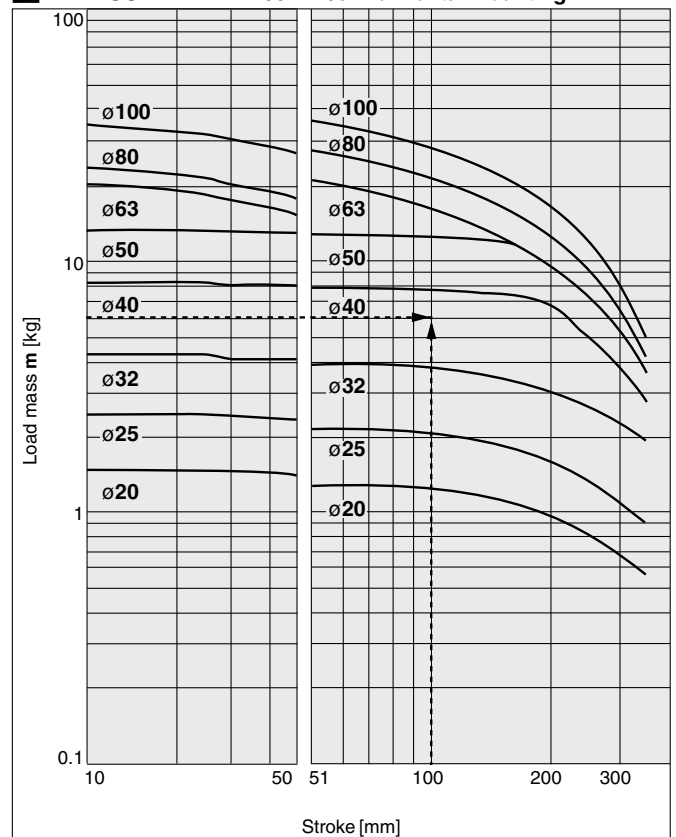

MLGP Series

Vertical Upward Mounting (Slide Bearing)

— Operating pressure: 0.4 MPa
 - - - - - Operating pressure: 0.5 MPa or more

MLGPM20 to 100

1 50 Stroke or Less v = 200 mm/s

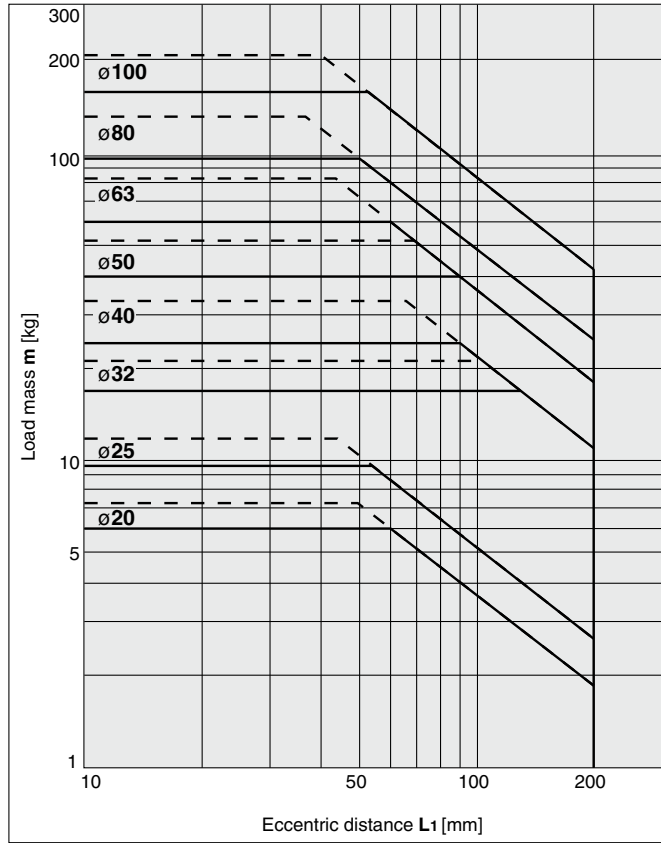

2 Over 50 Stroke v = 200 mm/s

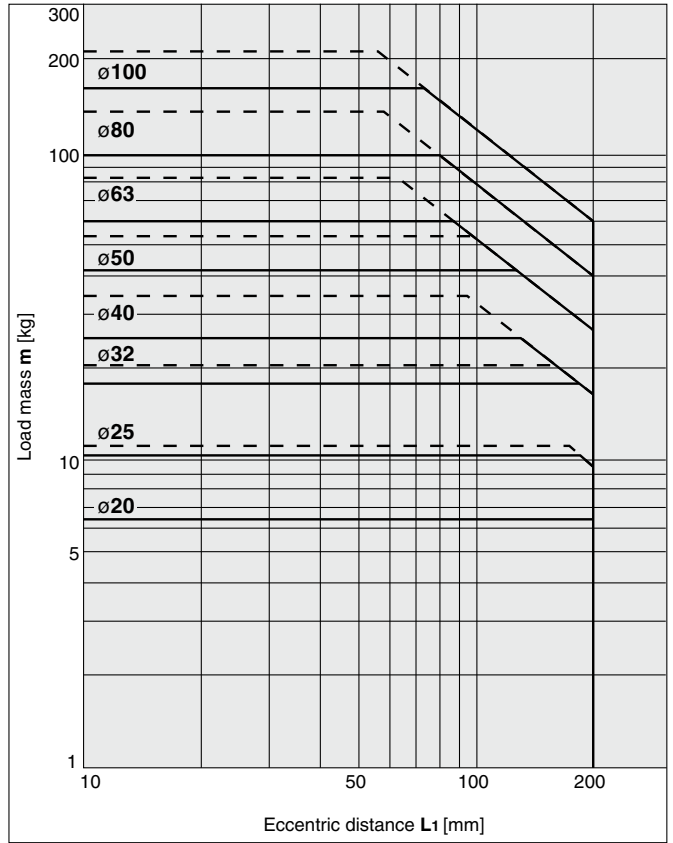

3 50 Stroke or Less v = 400 mm/s

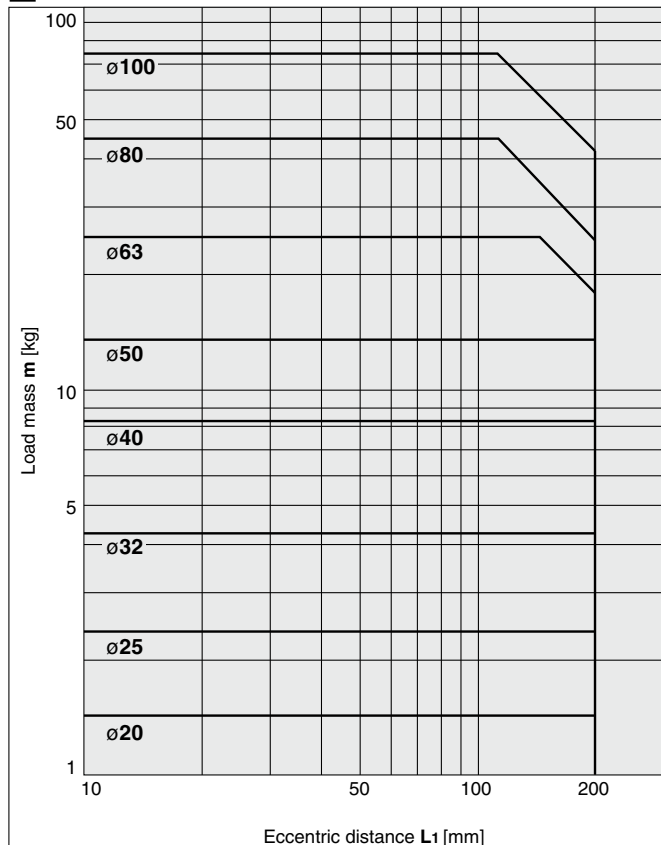

4 Over 50 Stroke v = 400 mm/s

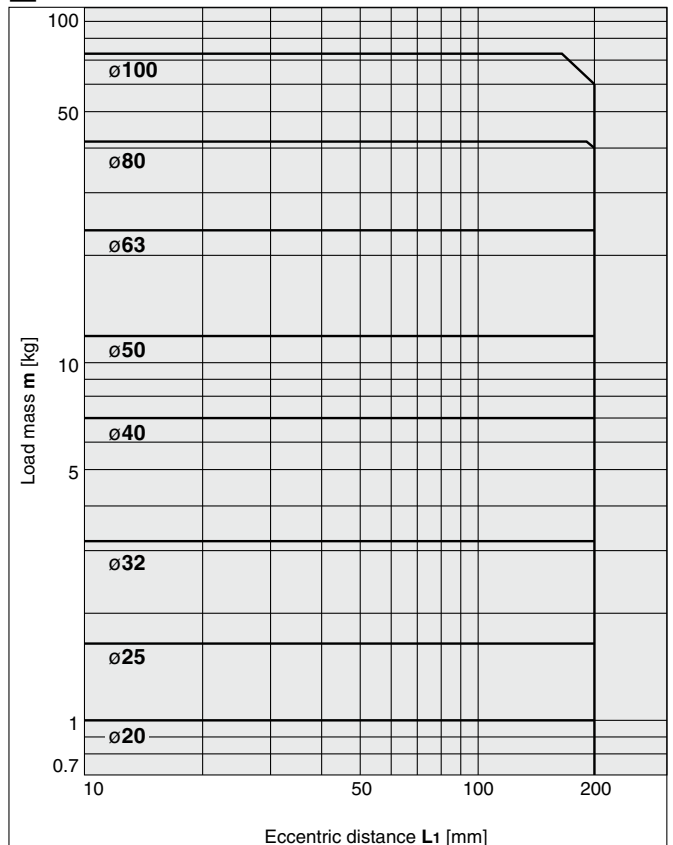

Vertical Upward Mounting (Ball Bushing Bearing)

— Operating pressure: 0.4 MPa
 - - - - - Operating pressure: 0.5 MPa or more

MLGPL20, 25

5 30 Stroke or Less $v = 200 \text{ mm/s}$

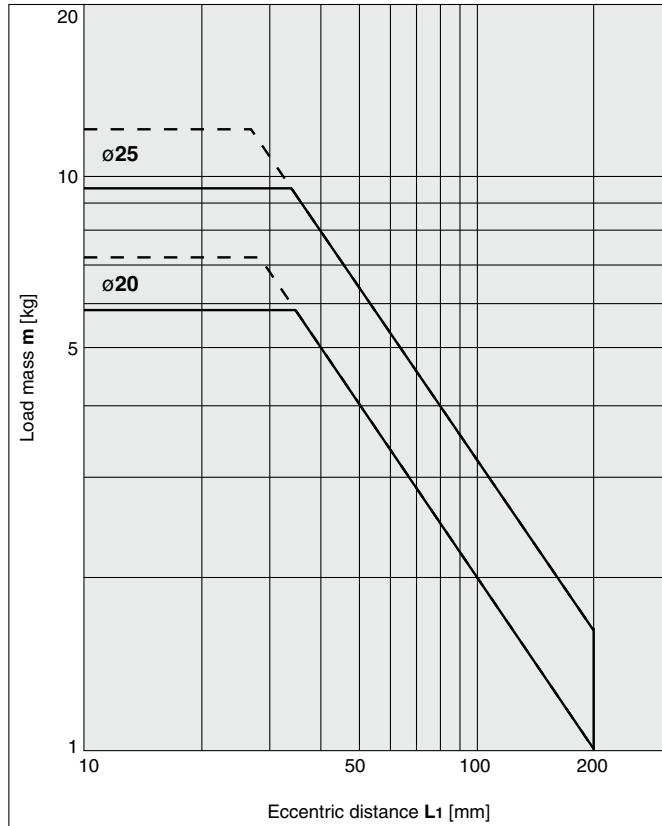

6 Over 30 Stroke $v = 200 \text{ mm/s}$

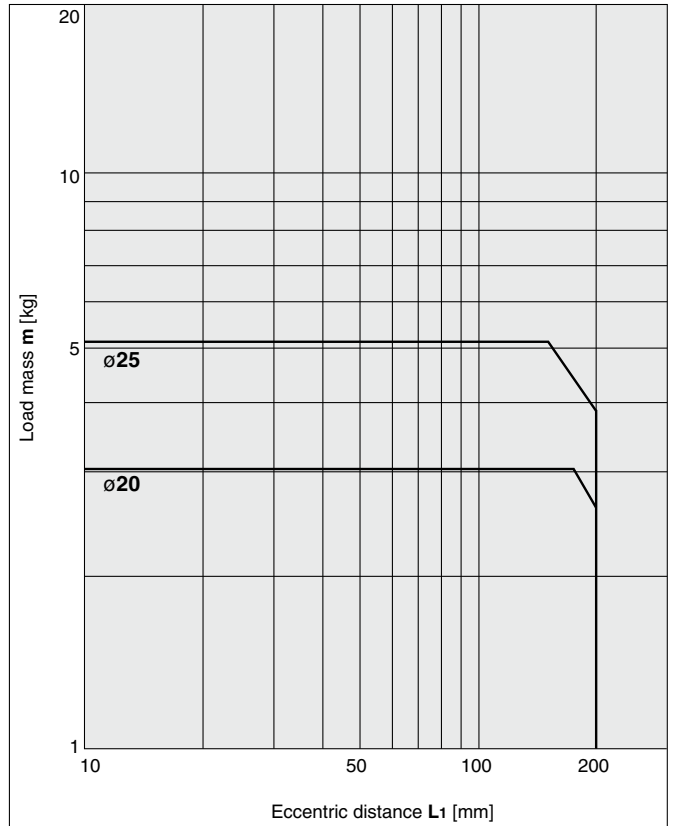

MLGPL32 to 100

7 50 Stroke or Less $v = 200 \text{ mm/s}$

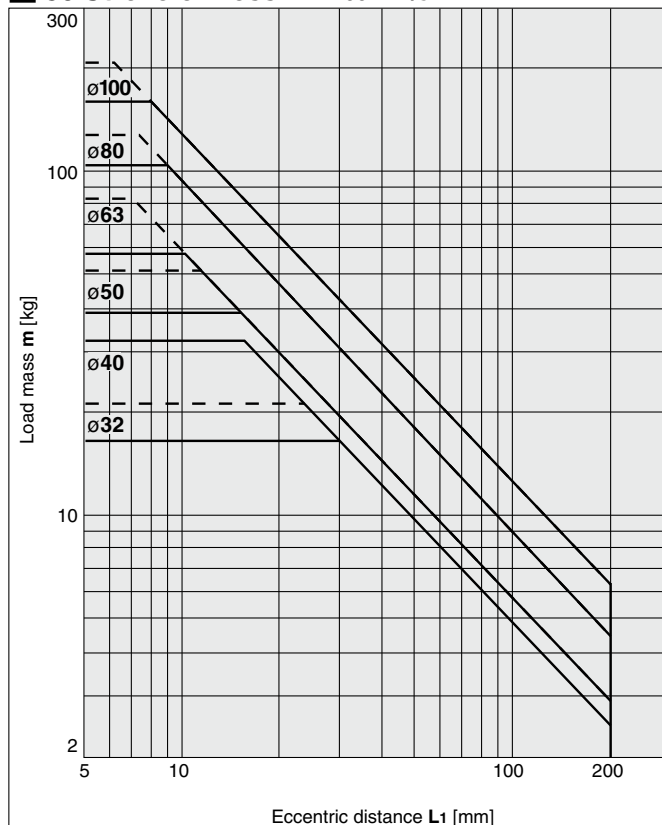

8 Over 50 Stroke $v = 200 \text{ mm/s}$

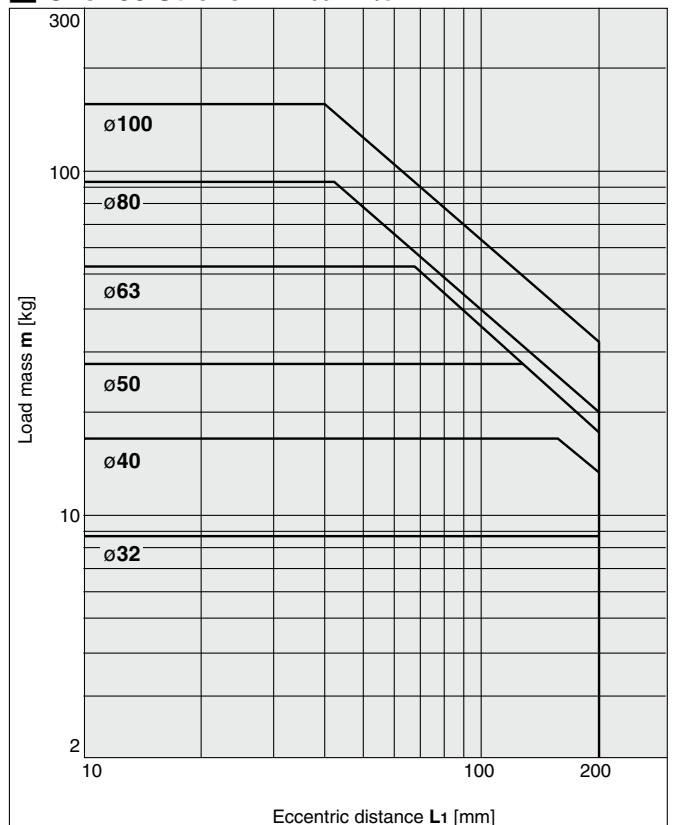

MLGP Series

Vertical Upward Mounting (Ball Bushing Bearing)

Operating pressure: 0.4 MPa

MLGPL20, 25

9 30 Stroke or Less $v = 400 \text{ mm/s}$

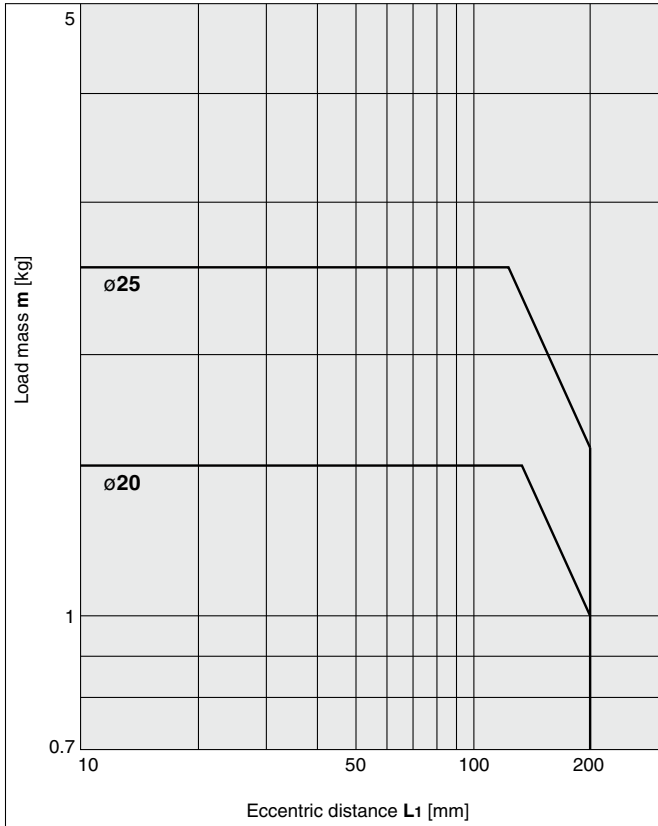

10 Over 30 Stroke $v = 400 \text{ mm/s}$

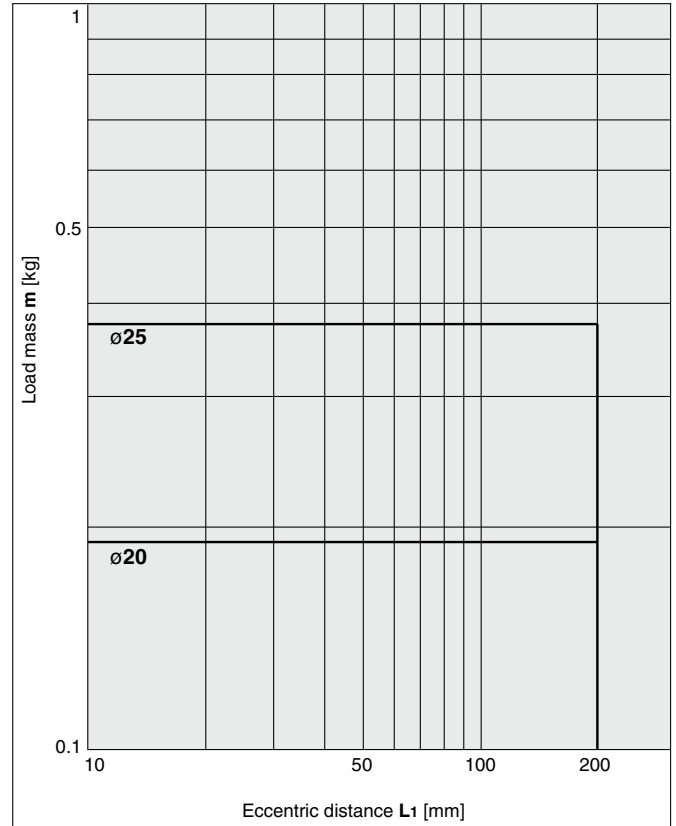

MLGPL32 to 100

11 50 Stroke or Less $v = 400 \text{ mm/s}$

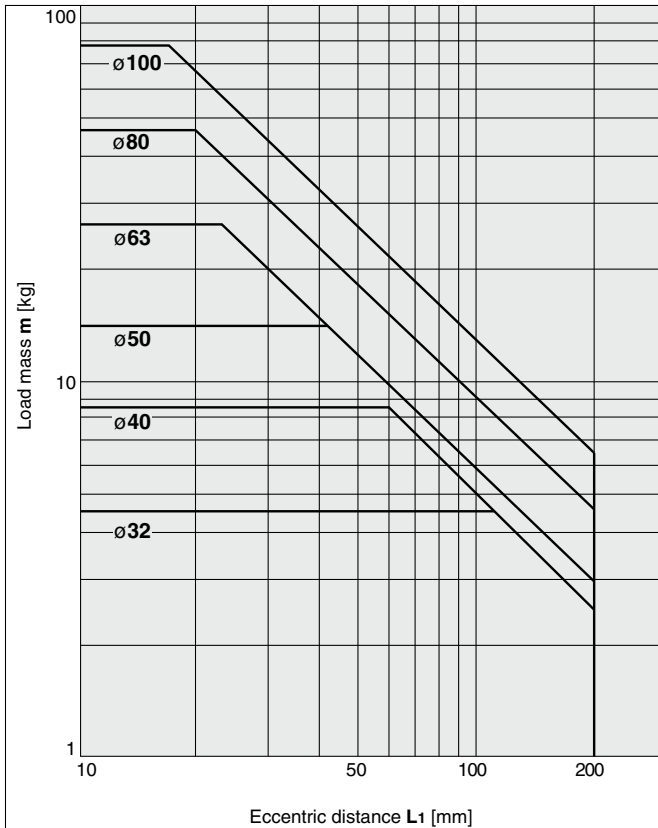

12 Over 50 Stroke $v = 400 \text{ mm/s}$

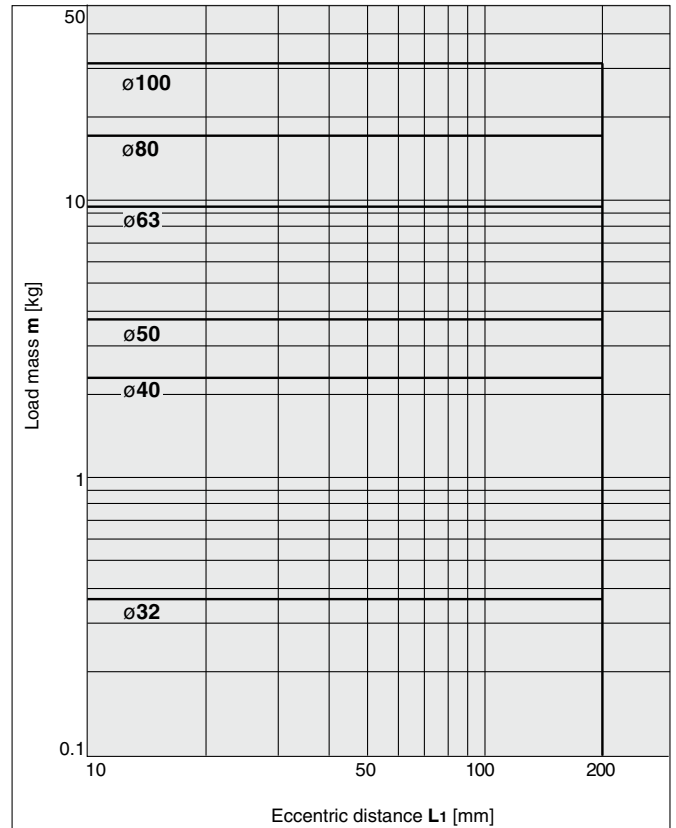

Vertical Downward Mounting (Slide Bearing)

—— Operating pressure: 0.4 MPa
 - - - - Operating pressure: 0.5 MPa or more

MLGPM20 to 100

13 50 Stroke or Less $v = 200 \text{ mm/s}$

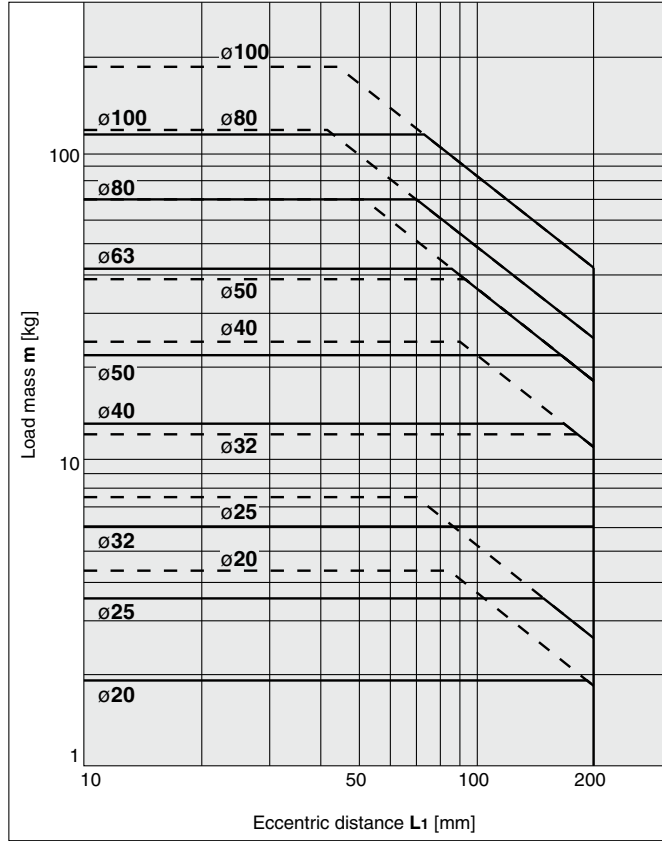

14 Over 50 Stroke $v = 200 \text{ mm/s}$

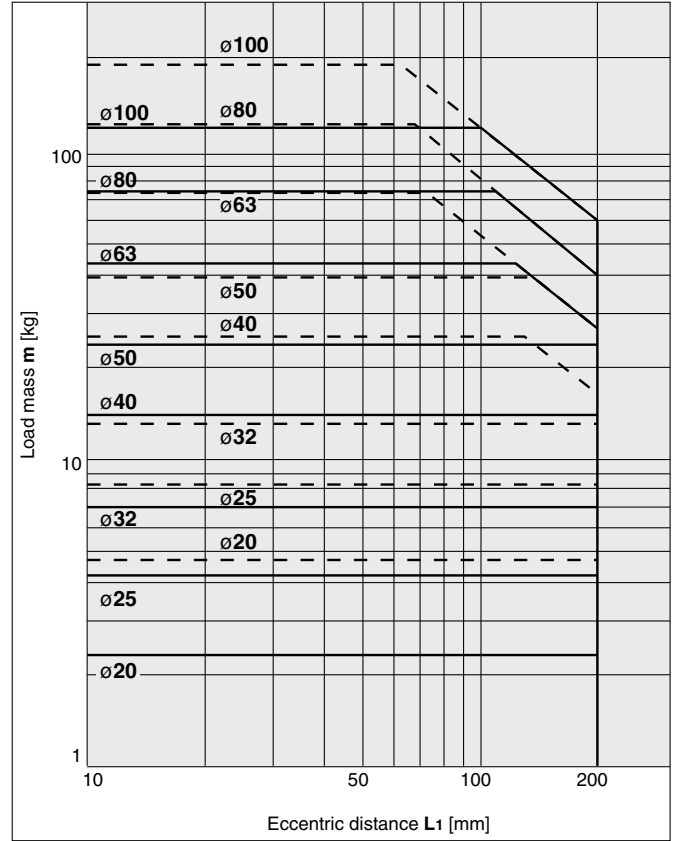

15 50 Stroke or Less $v = 400 \text{ mm/s}$

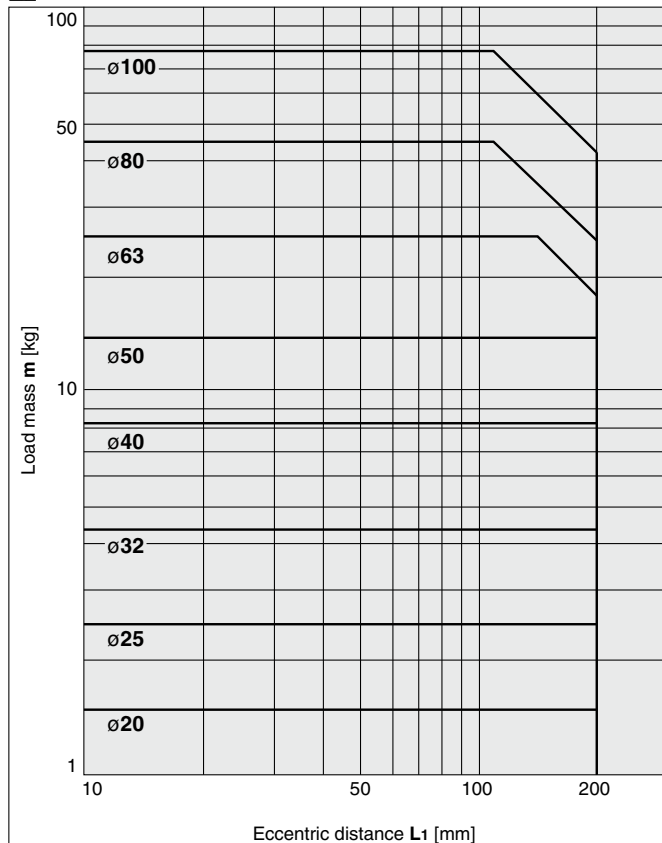

16 Over 50 Stroke $v = 400 \text{ mm/s}$

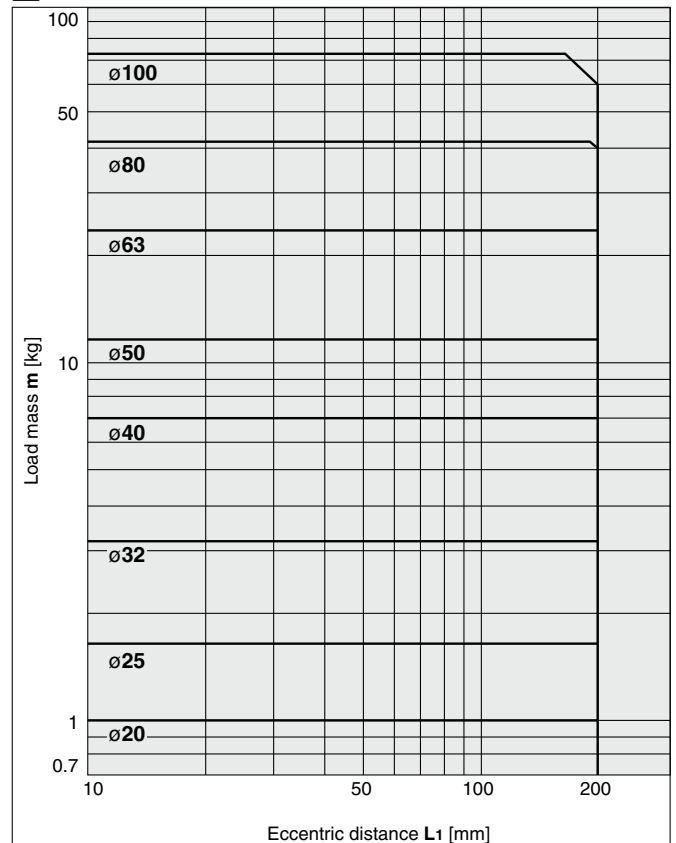

Vertical Downward Mounting (Ball Bushing Bearing)

—— Operating pressure: 0.4 MPa
 - - - - Operating pressure: 0.5 MPa or more

MLGPL20, 25

17 30 Stroke or Less $v = 200 \text{ mm/s}$

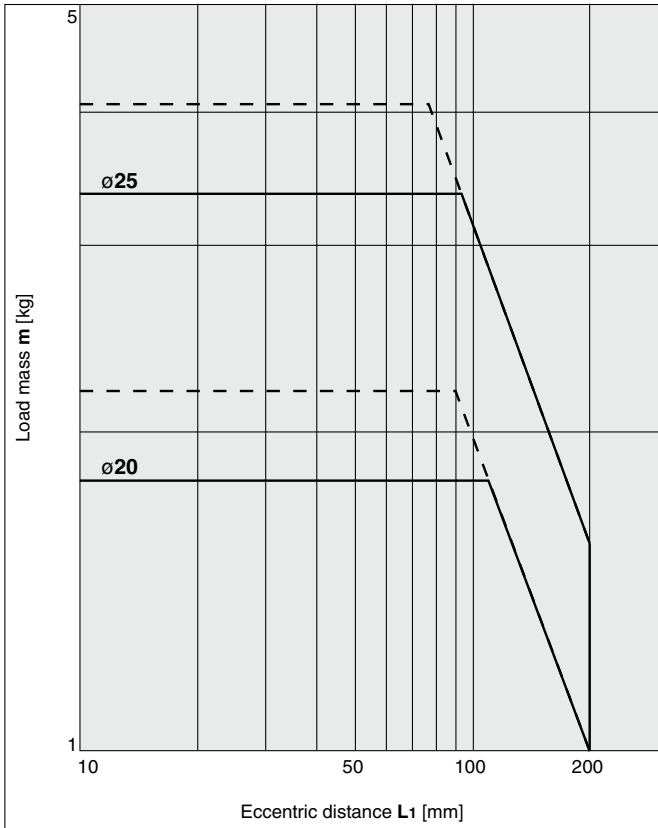

18 Over 30 Stroke $v = 200 \text{ mm/s}$

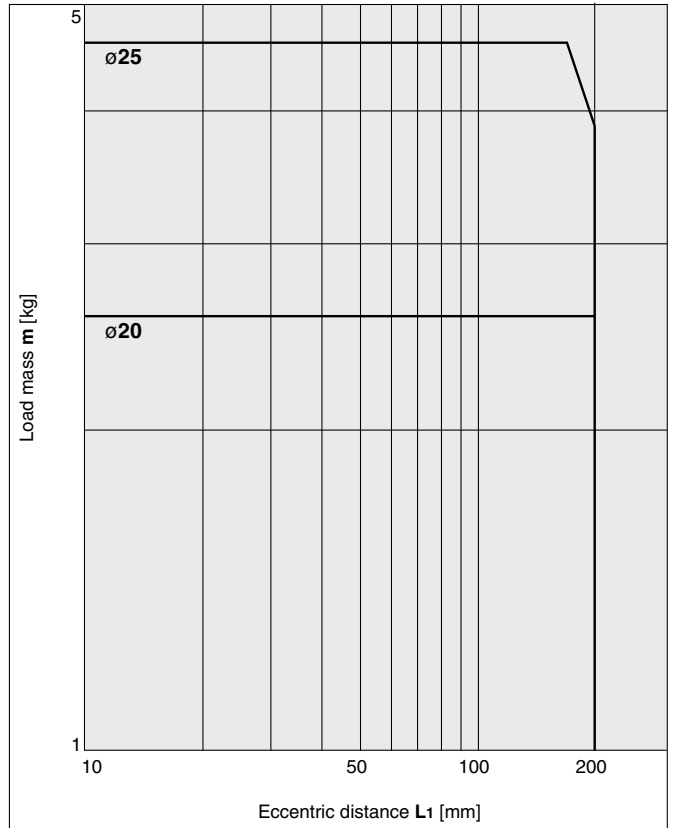

MLGPL32 to 100

19 50 Stroke or Less $v = 200 \text{ mm/s}$

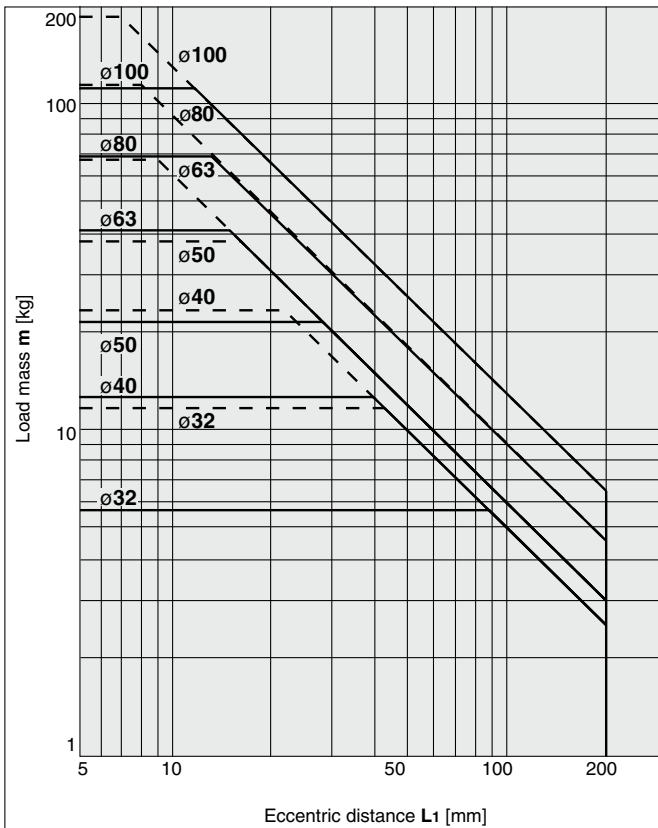

20 Over 50 Stroke $v = 200 \text{ mm/s}$

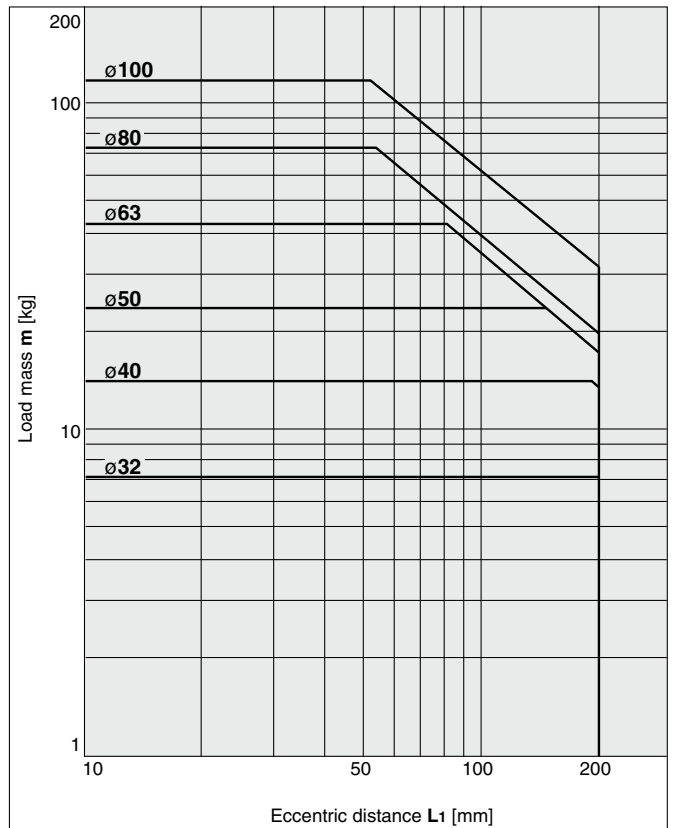

Vertical Downward Mounting (Ball Bushing Bearing)

Operating pressure: 0.4 MPa

MLGPL20, 25

21 30 Stroke or Less v = 400 mm/s

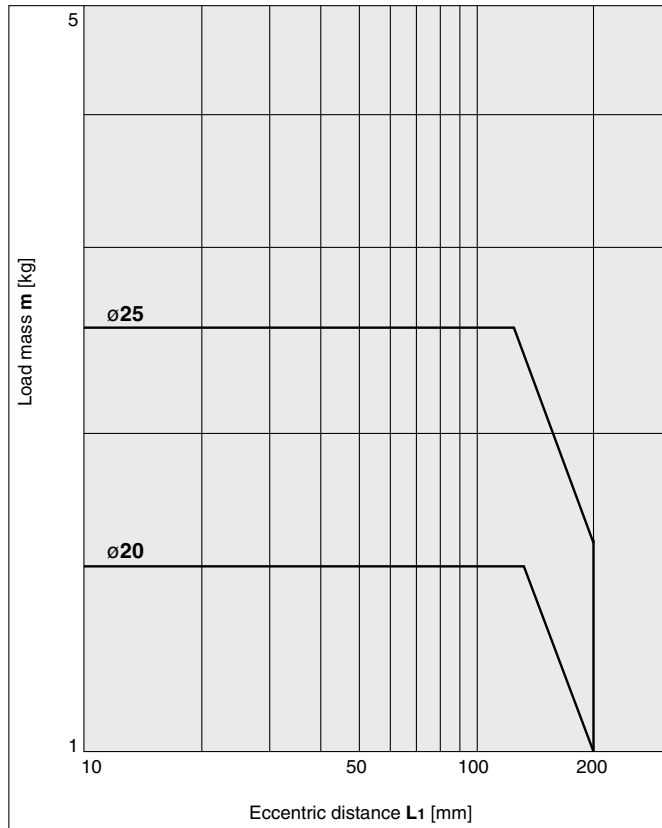

22 Over 30 Stroke v = 400 mm/s

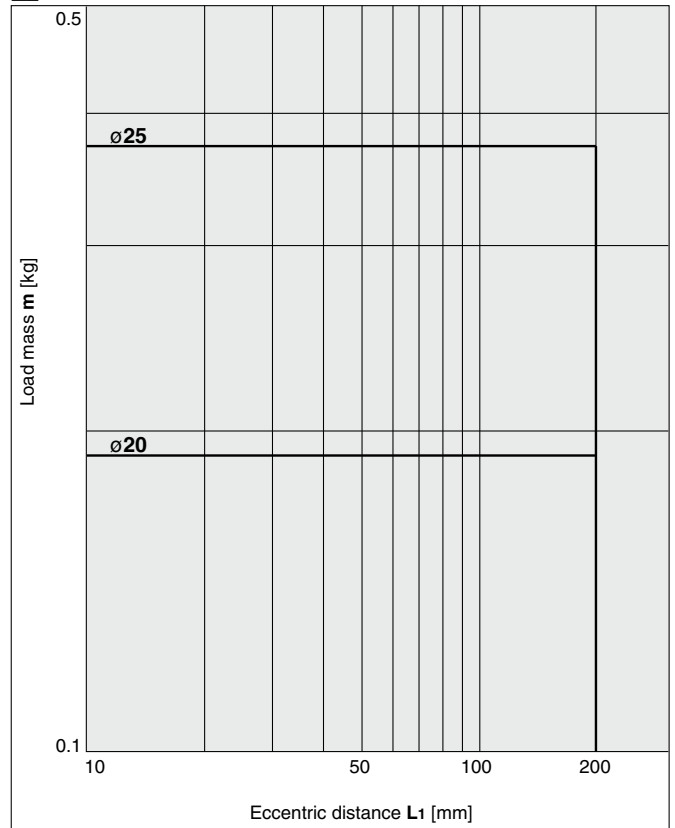

MLGPL32 to 100

23 50 Stroke or Less v = 400 mm/s

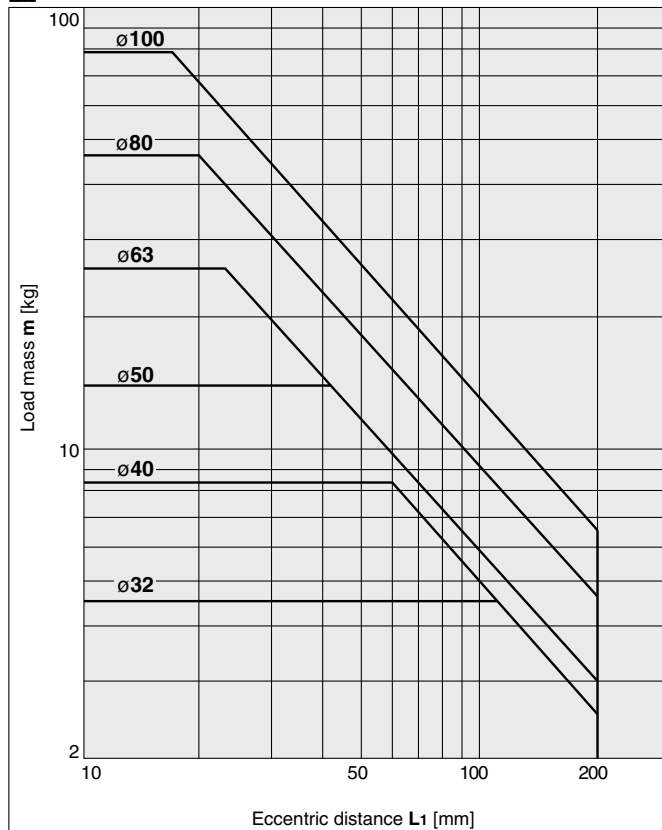

24 Over 50 Stroke v = 400 mm/s

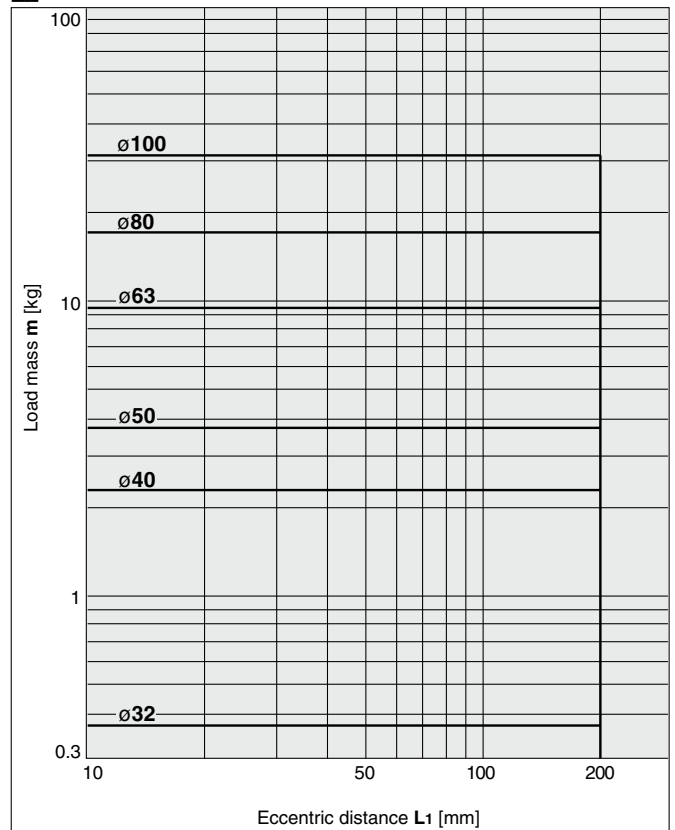

MLGP Series

Horizontal Mounting (Slide Bearing)

MLGPM20 to 100

25 L₂ = 50 mm V = 200 mm/s

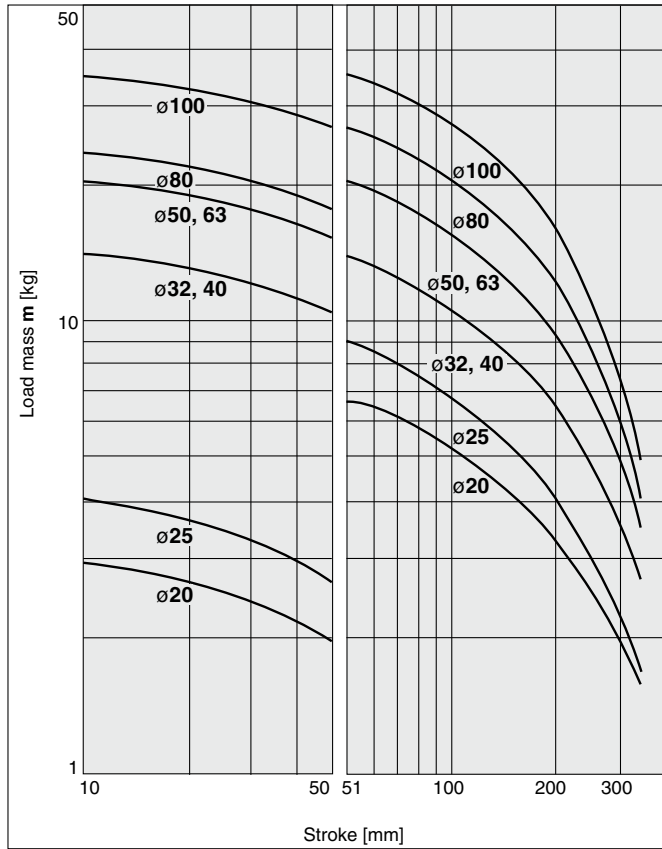

26 L₂ = 100 mm V = 200 mm/s

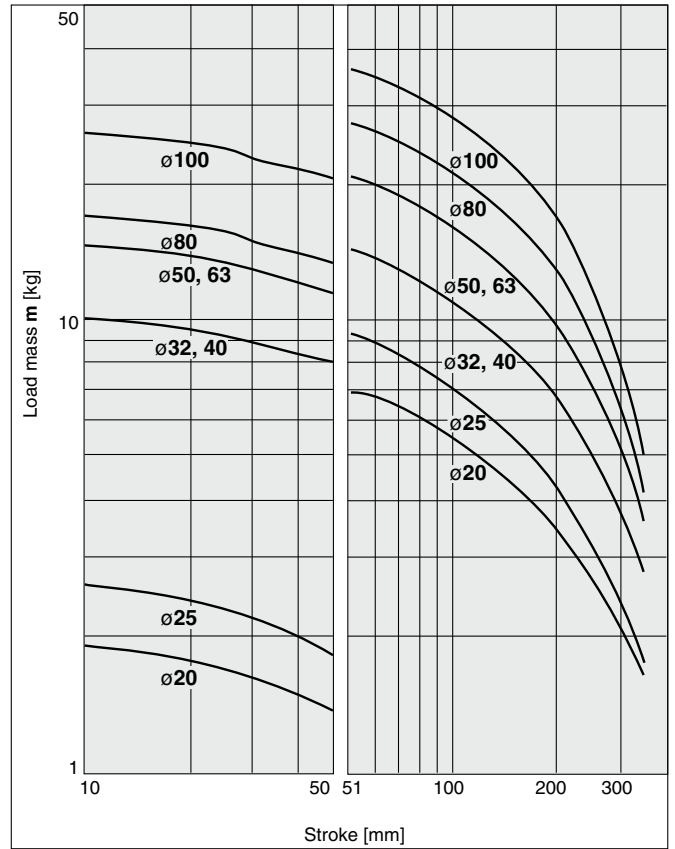

27 L₂ = 50 mm V = 400 mm/s

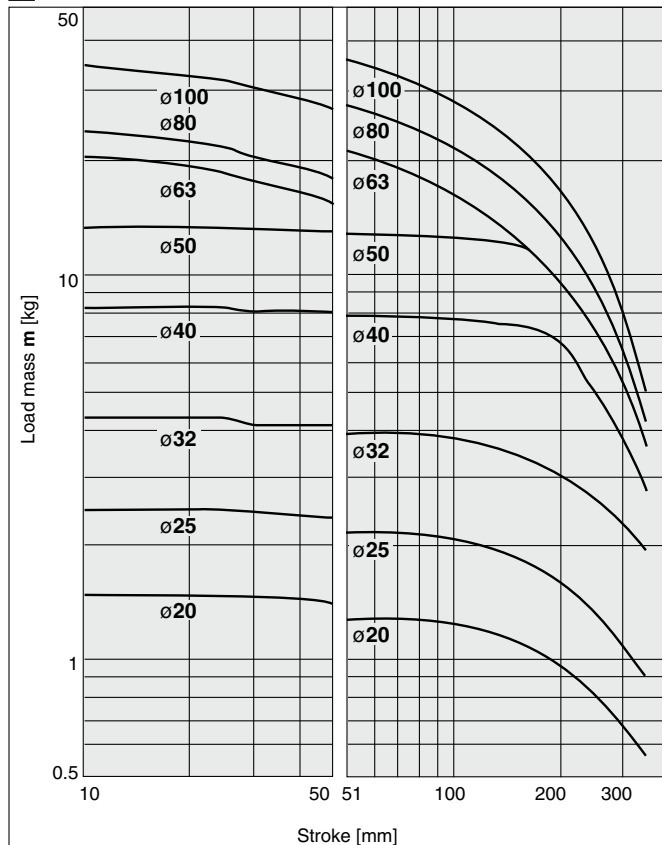

28 L₂ = 100 mm V = 400 mm/s

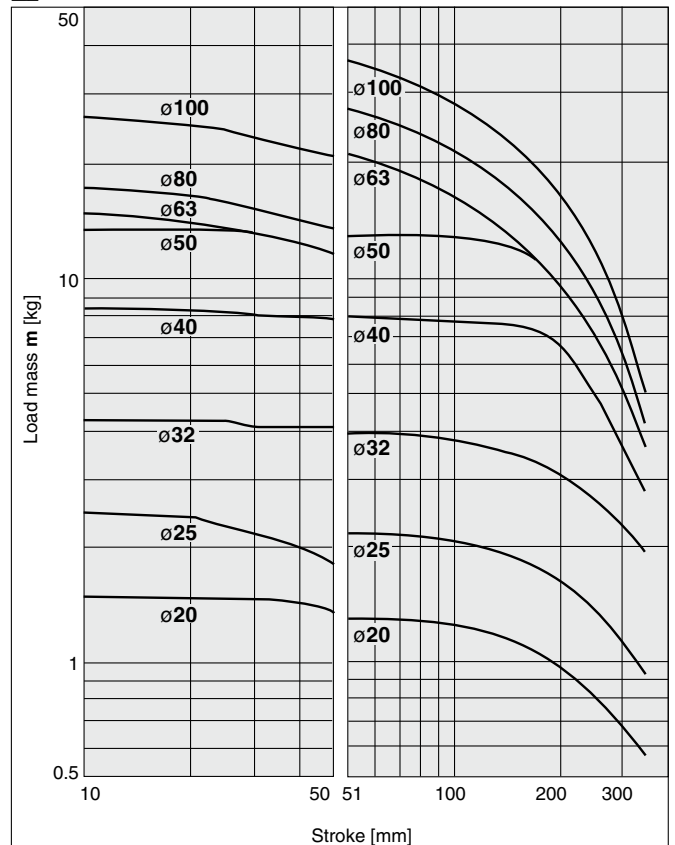

Horizontal Mounting (Ball Bushing Bearing)

29 L₂ = 50 mm V = 200 mm/s

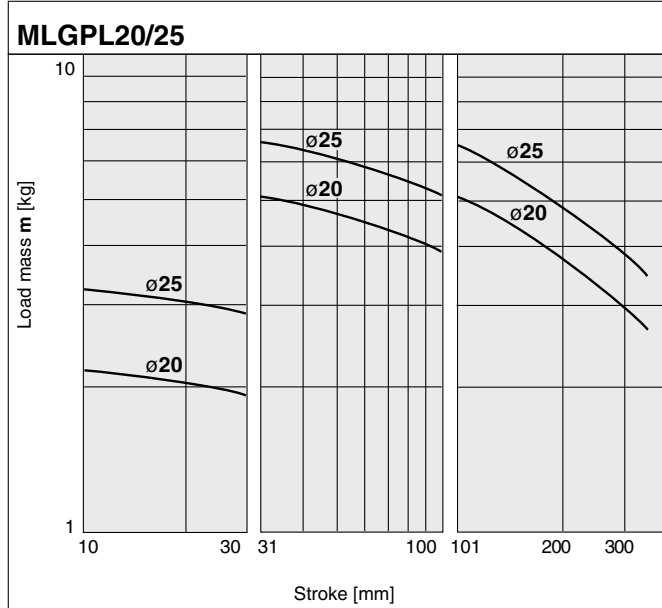

MLGPL32 to 63

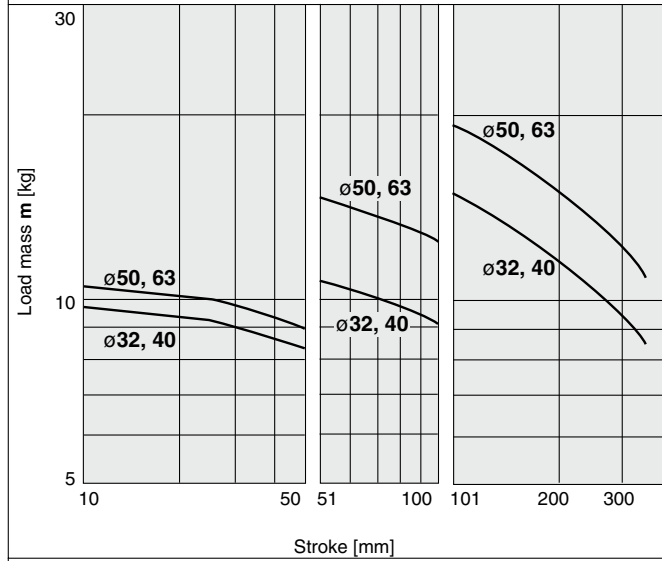

MLGPL80/100

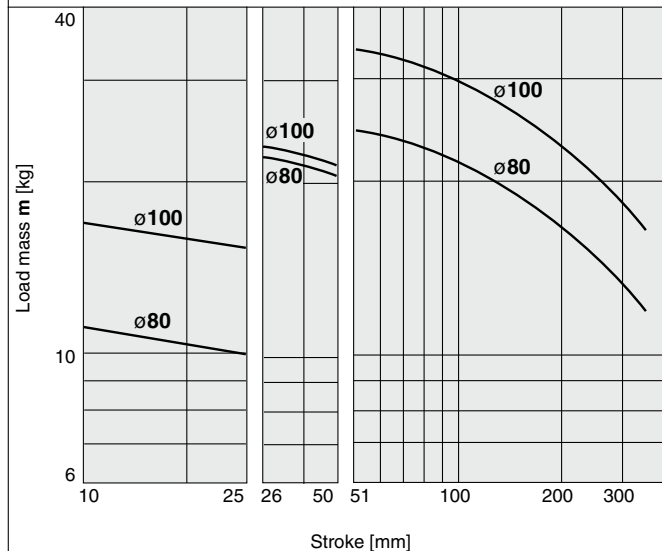

30 L₂ = 100 mm V = 200 mm/s

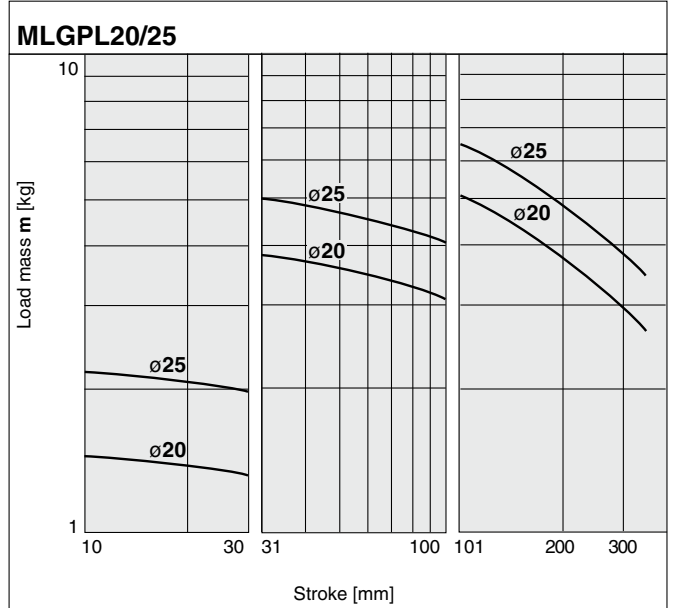

MLGPL32 to 63

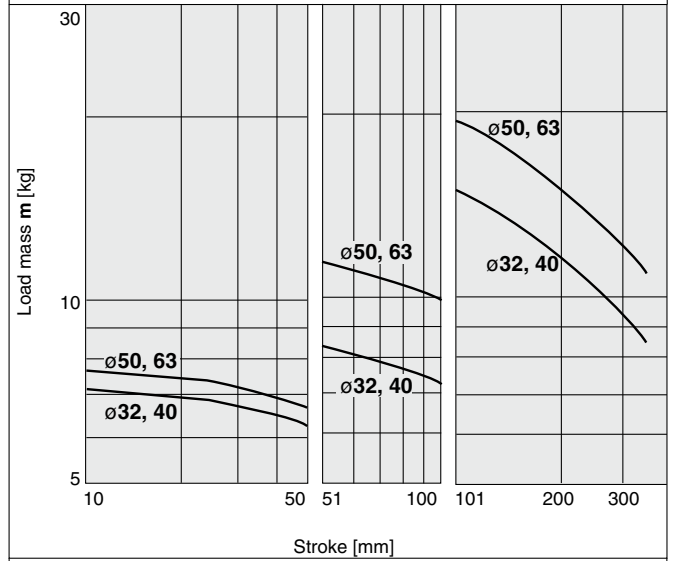

MLGPL80/100

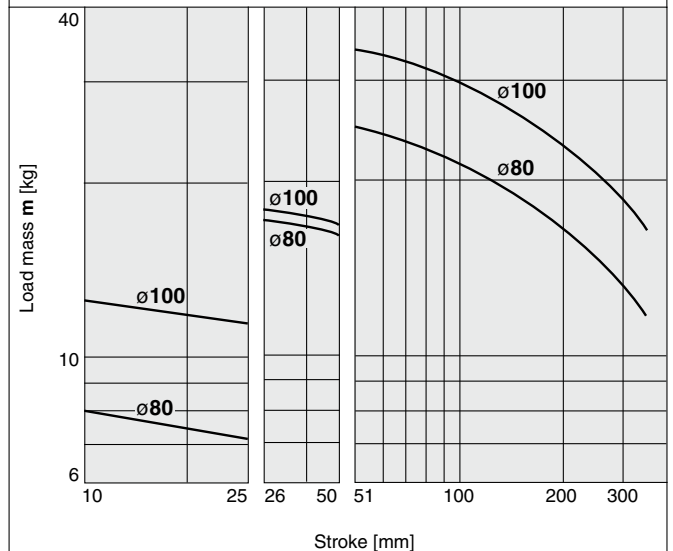

MLGP Series

Horizontal Mounting (Ball Bushing Bearing)

31 L₂ = 50 mm V = 400 mm/s

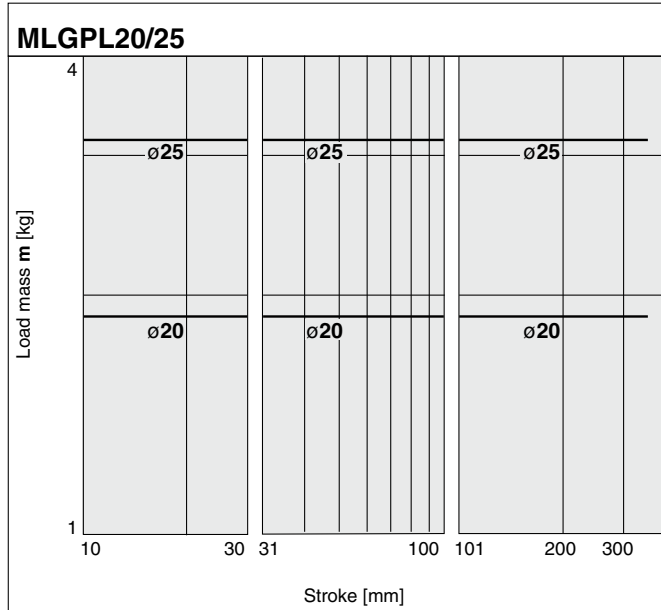

MLGPL32 to 63

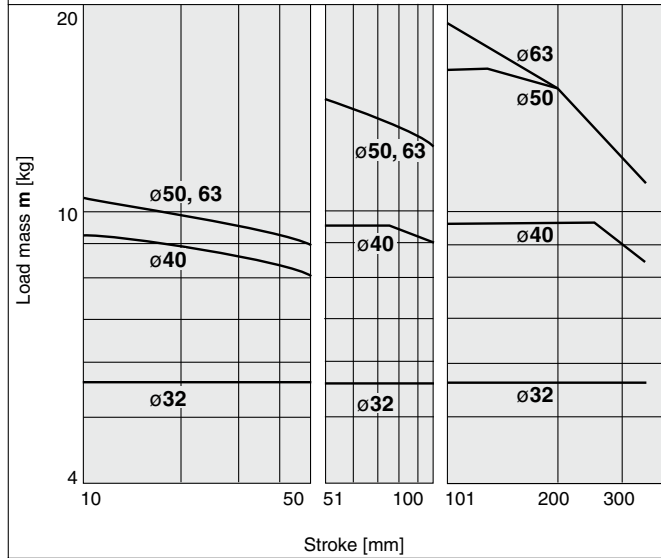

MLGPL80/100

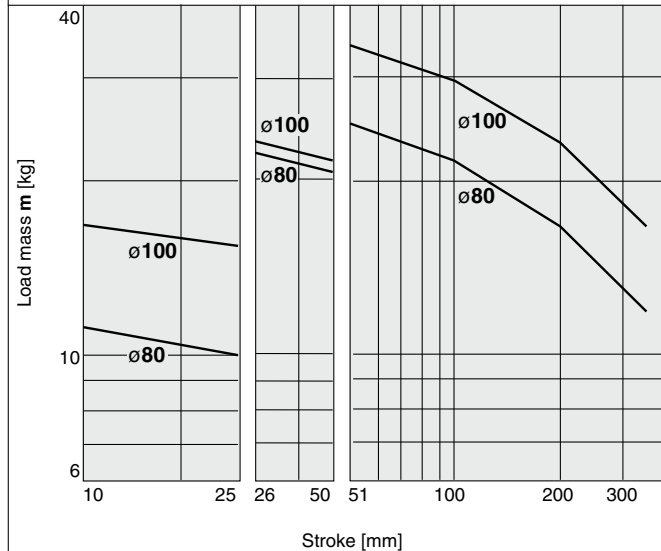

32 L₂ = 100 mm V = 400 mm/s

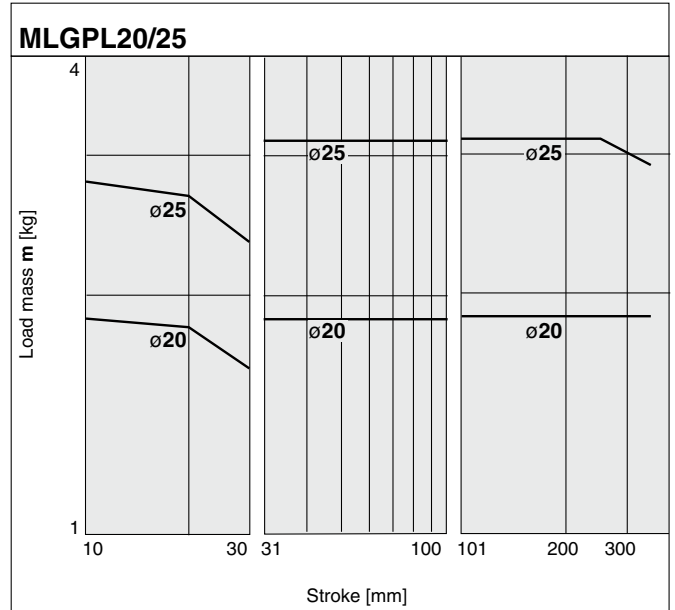

MLGPL32 to 63

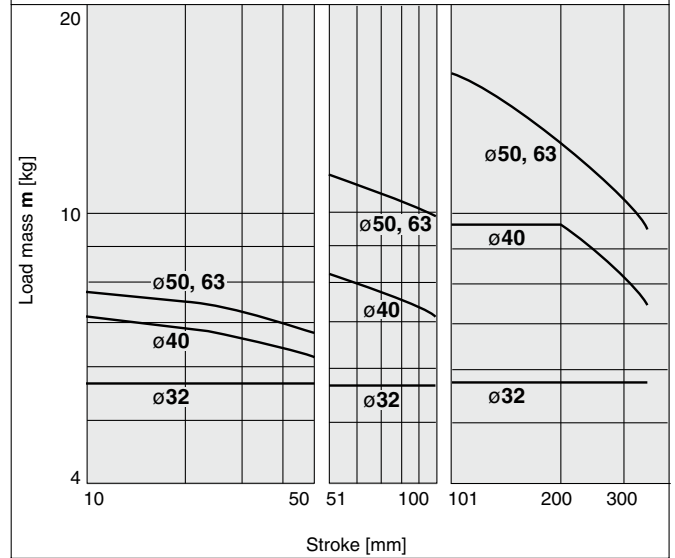

MLGPL80/100

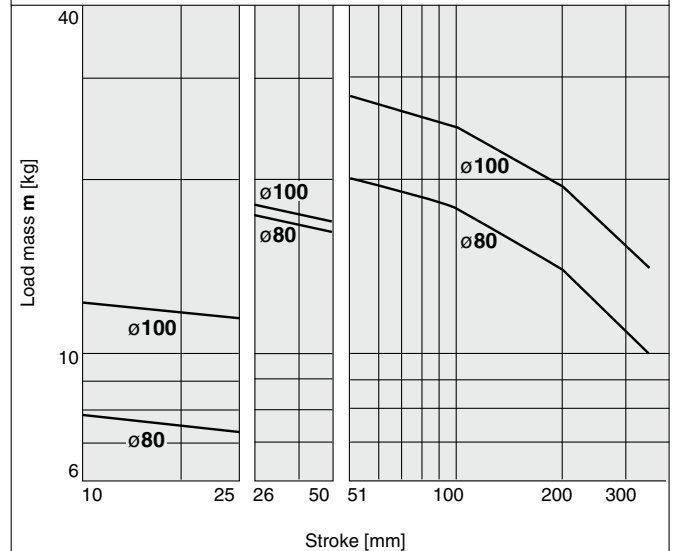

Operating Range when Used as Stopper

⚠ Warning

- When the product is used as a stopper, do not allow workpieces to collide in a locked state. If workpieces collide in the locked state, the lock may disengage due to the shock, or the lock mechanism and piston rod may be damaged, causing a dramatic decrease of the product life and/or further damage.
- Model MLGPL (Ball bushing bearing) cannot be used as a stopper.
When MLGPL (Ball bushing bearing) is used as a stopper, the impact will cause damage to the bearing unit and guide rod.
- Use the pneumatic circuit on page 30, when the product is used as a stopper, so that the workpiece does not collide in a locked state.

⚠ Caution

- When using as a stopper, select a model with 30 stroke or less for bore sizes $\phi 20$ and $\phi 25$, and 50 stroke or less for bore sizes $\phi 32$ to $\phi 100$.
- When selecting a model with a longer L dimension, be sure to choose a bore size which is sufficiently large.

MLGPM20/25 (Slide Bearing)

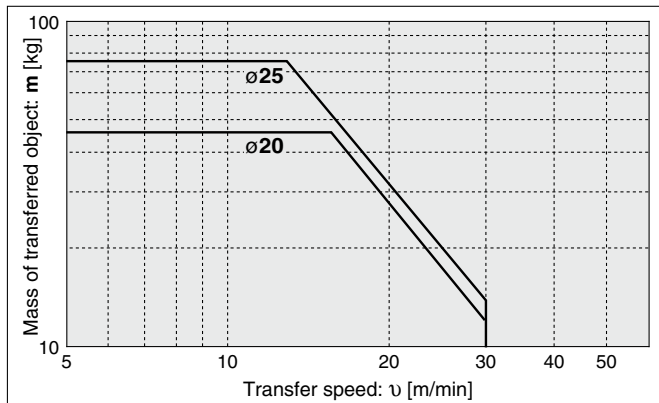
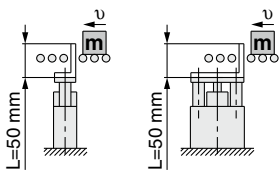

MLGPM32 to 100 (Slide Bearing)

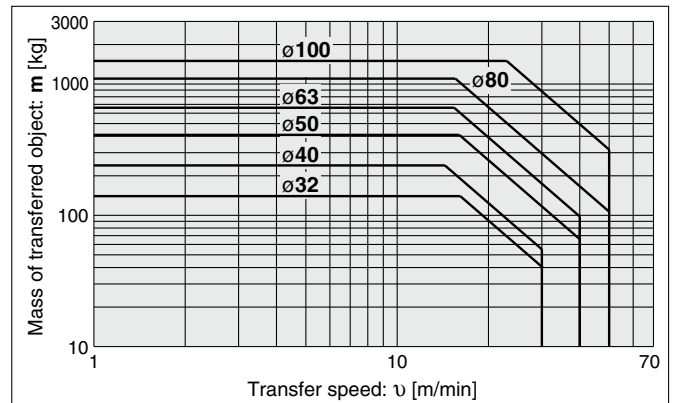
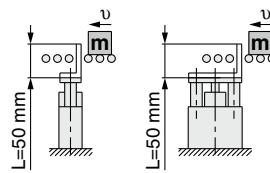

Allowable Kinetic Energy

⚠ Caution

Load mass and a maximum speed must be within the ranges shown below.

MLGP with Rubber Bumper

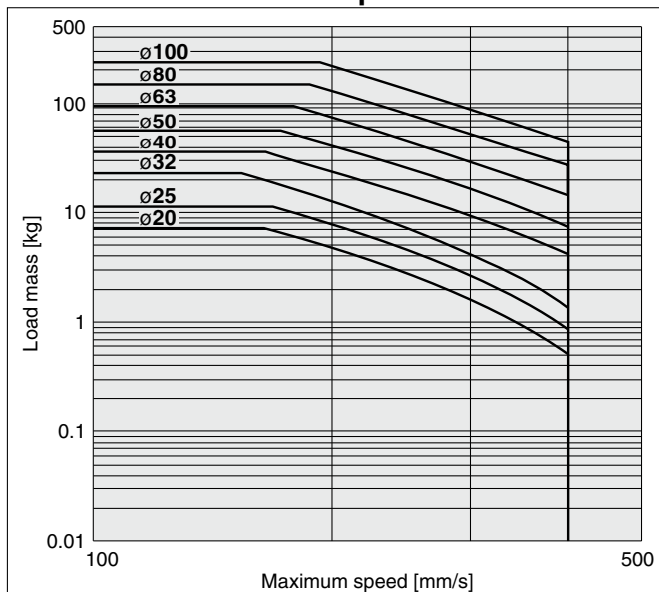



MLGP Series

Specific Product Precautions 1

Be sure to read this before handling the products. Refer to the back cover for safety instructions. For actuator and auto switch precautions, refer to the “Handling Precautions for SMC Products” and the “Operation Manual” on the SMC website: <https://www.smcworld.com>

Selection

Warning

- 1. The holding force (max. static load) indicates the maximum capability to hold a static load without vibration and impact. Therefore, the maximum load (workpiece mass) should not exceed 50% of the holding force (max. static load). Select the load mass when unlocked in accordance with 6 below.**
- 2. Do not use for intermediate stops while the cylinder is operating.**

This cylinder is designed for locking against inadvertent movement from a stationary condition. Do not perform intermediate stops while the cylinder is operating, as this may cause unlocking malfunction, damage or shorten the service life.
- 3. Select the correct locking direction, as this cylinder does not generate holding force opposite to the locking direction.**

The extension locking does not generate holding force in the cylinder's retracting direction, and the retraction locking does not generate holding force in the cylinder's extension direction.
- 4. Even when locked, there may be a stroke movement of approximately 1 mm in the locking direction due to external forces, such as the workpiece mass.**

Even when locked, if air pressure drops, a stroke movement of approximately 1 mm may be generated in the locking direction of the lock mechanism due to external forces such as the workpiece mass.
- 5. When in the locked state, do not apply a load accompanied by an impact shock, strong vibration or turning force, etc.**

This may damage the locking mechanism, shorten the service life or cause unlocking malfunction.
- 6. Operate so that load mass, cylinder speed and eccentric distance are within the limiting ranges in the specifications and model selection graphs.**

If the products are used beyond the limiting range, it may lead to a reduced service life or cause damage to the machinery. (Refer to pages 6 and 7 for specifications and pages 17 to 28 for the Model Selection.)

Pneumatic Circuit

Warning

- <Drop prevention circuit> * Refer to page 30 for circuit examples.
- 1. Do not use 3-position valves with circuit example 1.**

The lock may be released due to inflow of the unlocking pressure.
 - 2. Install speed controllers for meter-out control. (Circuit example 1)**

When they are not installed or they are used under meter-in control, it may cause malfunction.
 - 3. Branch off the compressed air piping for the lock unit between the cylinder and the speed controller. (Circuit example 1)**

Note that branching off in another section can cause a reduction in service life.
 - 4. Perform piping so that the side going from the piping junction to the lock unit is short. (Circuit example 1)**

If the lock release port side is longer than another side from the piping junction, this may cause unlocking malfunction or shorten the service life.

Pneumatic Circuit

Warning

- 5. Be aware of reverse exhaust pressure flow from common exhaust type valve manifolds. (Circuit example 1)**

Since the lock may be released due to reverse exhaust pressure flow, use an individual exhaust type manifold or single type valve.
- 6. Be sure to release the lock before operating the cylinder. (Circuit example 2)**

When the lock release delays, the cylinder may eject at high speed, which is extremely dangerous. It may also damage the cylinder, greatly shorten the service life, or cause locking malfunction. Even when a cylinder moves freely, be sure to release the lock when operating the cylinder.
- 7. Be aware that the locking action may be delayed due to the piping length or the timing of exhaust. (Circuit example 2)**

The locking action may be delayed due to the piping length or the timing of exhaust, which also makes the stroke movement toward the lock larger. Install the solenoid valve for locking closer to the cylinder than the cylinder drive solenoid valve.

<Emergency stop circuit>

- 1. Perform emergency stops with the pneumatic circuit. (Circuit examples 3 and 4)**

This cylinder is designed for locking against inadvertent movement from a stationary condition. Do not perform emergency stops while the cylinder is operating, as this may cause unlocking malfunction, damage or shorten the service life. Emergency stops must be performed with the pneumatic circuit, and workpieces must be held with the locking mechanism after the cylinder fully stops.
- 2. When restarting the cylinder from the locked state, remove the workpiece and exhaust the residual pressure in the cylinder. (Circuit examples 3 and 4)**

The cylinder may eject at high speed, which is extremely dangerous. It may also damage the cylinder, greatly shorten the service life, or cause locking malfunction.
- 3. Be sure to release the lock before operating the cylinder. (Circuit example 4)**

When the lock release delays, the cylinder may eject at high speed, which is extremely dangerous. It may also damage the cylinder, greatly shorten the service life, or cause locking malfunction. Even when the cylinder moves freely, be sure to release the lock when operating the cylinder.

<Drop prevention circuit, Emergency stop circuit>

- 1. If installing a solenoid valve for a lock unit, be aware that repeated supply and exhaustion of air may cause condensation. (Circuit examples 2 and 4)**

The lock unit operating stroke is very small and so the pipe is long. If supplying and exhausting air repeatedly, condensation, which occurs by adiabatic expansion, accumulates in the lock unit. This may then cause air leakage and an unlocking malfunction due to corrosion of internal parts.



MLGP Series

Specific Product Precautions 2

Be sure to read this before handling the products. Refer to the back cover for safety instructions. For actuator and auto switch precautions, refer to the "Handling Precautions for SMC Products" and the "Operation Manual" on the SMC website: <https://www.smcworld.com>

Pneumatic Circuit

Warning

Circuit examples

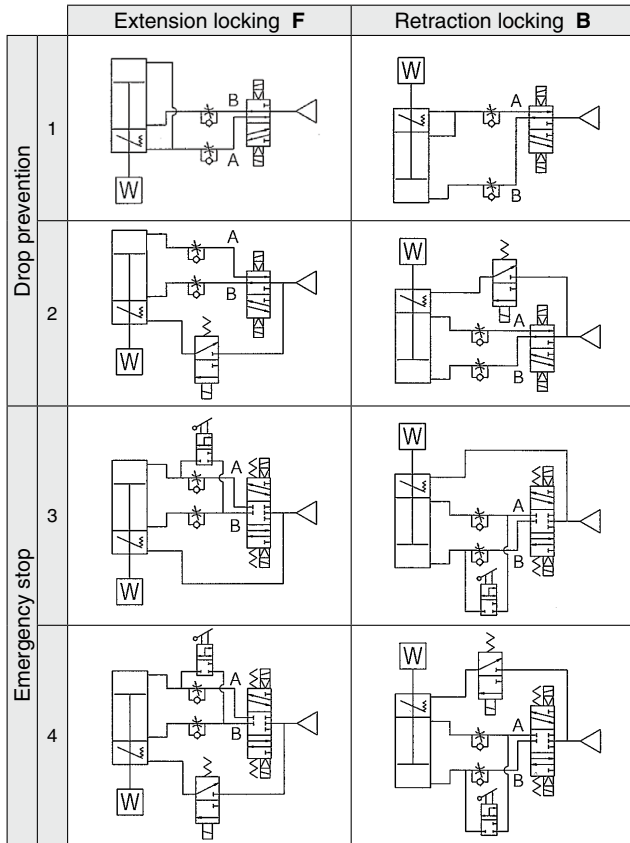

<Stopper circuit>

- When used as a stopper, be careful that the workpiece does not collide with the cylinder in a locked state. Use the guide cylinder with the circuit below.

If the workpiece were bumped into the cylinder in the locked state, it could be unlocked by shock or the locking mechanism and the piston rod could be damaged, that could shorten its service life substantially or result in breakage.

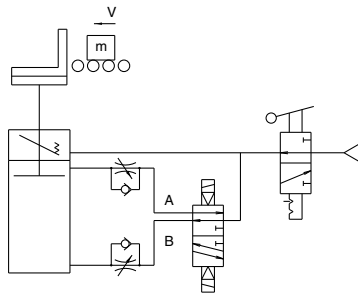

MLGPM-□-B: When used as stopper

* The symbol for the cylinder with lock in the basic circuit uses SMC original symbol.

Mounting

Warning

- Take precautions to prevent your fingers or hands from getting caught between the plate and the cylinder body or the lock body.

Be very careful to prevent your hands or fingers from getting caught in the gap between the cylinder body and the lock body when air is applied.

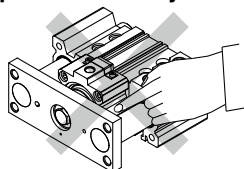

Mounting

Caution

- Be sure to connect the load to the plate section with the lock in an unlocked state.

If this is done in the locked state, it may cause damage to the lock mechanism.

Sizes $\varnothing 20$ to $\varnothing 32$ have a built-in holding function for the unlocked state, allowing the unlocked state to be maintained even without an air supply. For $\varnothing 40$ to $\varnothing 100$, simply connect piping to the unlocking port and supply air pressure of 0.2 MPa or more.

- When performing mounting adjustment, supply air pressure only to the unlocking port.

- Use cylinders within the piston speed range.

An orifice is set for this cylinder, but the piston speed may exceed the operating range if the speed controller is not used. If the cylinder is used outside the operating speed range, it may cause damage to the cylinder and shorten the service life. Adjust the speed by installing the speed controller and use the cylinder within the limited range.

- Pay attention to the operating speed when the product is mounted vertically.

When using the product in the vertical direction, if the load factor is large, the operating speed can be faster than the control speed of the speed controller (i.e. quick extension). In such cases, it is recommended to use a dual speed controller.

- Do not scratch or dent the sliding portion of the piston rod and the guide rod.

Damaged seals, etc. will result in leakage or malfunction.

- Do not dent or scratch the mounting surface of a body and a plate.

The flatness of the mounting surface may not be maintained, which would cause an increase in sliding resistance.

- Make sure that the cylinder mounting surface has a flatness of 0.05 mm or less.

If the flatness of the workpieces and brackets mounted on the plate is not appropriate, sliding resistance may increase.

If it is difficult to maintain a flatness of 0.05 mm or less, put a thin shim ring (provided by the customer) between the plate and the workpiece mounting surface to prevent the sliding resistance from increasing.

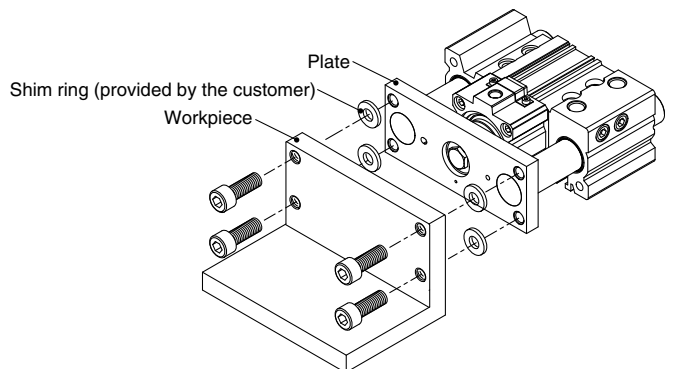



MLGP Series Specific Product Precautions 3

Be sure to read this before handling the products. Refer to the back cover for safety instructions. For actuator and auto switch precautions, refer to the "Handling Precautions for SMC Products" and the "Operation Manual" on the SMC website: <https://www.smcworld.com>

Mounting

⚠ Caution

8. Cylinder bottom

Since the guide rods project from the bottom of the cylinder at the end of the retraction stroke, provide bypass ports in the mounting surface, as well as holes for the hexagon socket head mounting screws, when the cylinder is mounted from the bottom.

Furthermore, when subjected to impact in use as a stopper, etc., screw the mounting bolts in to a depth of 2d or more.

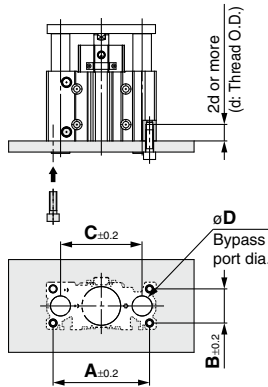

Bore size [mm]	A [mm]	B [mm]	C [mm]	D		Hexagon socket head cap screw
				MLGPM	MLGPL	
20	72	24	54	14	12	M5 x 0.8
25	82	30	64	18	15	M6 x 1.0
32	98	34	78	22	18	M8 x 1.25
40	106	40	86	22	18	M8 x 1.25
50	130	46	110	27	22	M10 x 1.5
63	142	58	124	27	22	M10 x 1.5
80	180	54	156	33	28	M12 x 1.75
100	210	62	188	39	33	M14 x 2.0

Piping

⚠ Caution

1. Depending on the operating condition, change the position of plugs for the piping port.

• Tapered thread for Rc port (MLGP) and NPT port (MLGP□□TN)

Tighten with proper tightening torques below. Also, use sealant tape on the plug. With regard to the sunk dimension of a plug ("a" dimension in the drawing), use the stipulated figures as a guide and confirm the air leakage before operation.

* If plugs on the top mounting port are tightened with more than the proper tightening torque, they will be screwed too deeply and the air passage will be constricted, resulting in limited cylinder speed.

Connection thread (plug) size	Applicable tightening torque [N·m]	a dimension
1/8	7 to 9	0.5 mm or less
1/4	12 to 14	1 mm or less
3/8	22 to 24	1 mm or less

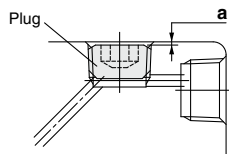

• Parallel pipe thread for G port (MLGP□□TF)

Screw in the plug to the surface of the body ("a" dimension in the drawing) by checking visually instead of using the tightening torque shown in the table.

Preparing for Operation

⚠ Warning

1. Before restarting the cylinder from the locked state, be sure to restore air pressure to the B port of the solenoid valve in the pneumatic circuit.

When pressure is not applied to the B port of the solenoid valve, the load may drop or the cylinder may eject at high speed, which is extremely dangerous. It may also damage the cylinder, greatly shorten the service life or cause unlocking malfunction. When applying pressure to the B port, be sure to confirm whether the environment is safe, since workpieces may move.

2. Since sizes $\varnothing 20$ to $\varnothing 32$ are shipped in the unlocked state maintained by the unlocking bolt, be sure to remove the unlocking bolt following the steps below.

If the cylinder is used without removing the unlocking bolt, the lock mechanism will not function.

For $\varnothing 20$ to $\varnothing 32$ only

- 1) Confirm that there is no air pressure inside the cylinder, and remove the dust cover 1.
- 2) Supply air pressure of 0.2 MPa or more to unlocking port 2 shown on the right.
- 3) Remove the unlocking bolt 3 with a hexagon wrench (width across flats 2.5).

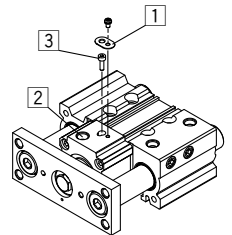

* Since a holding function for the unlocked state is not available for sizes $\varnothing 40$ to $\varnothing 100$, they can be used as shipped.



MLGP Series Specific Product Precautions 4

Be sure to read this before handling the products. Refer to the back cover for safety instructions. For actuator and auto switch precautions, refer to the "Handling Precautions for SMC Products" and the "Operation Manual" on the SMC website: <https://www.smcworld.com>

Manually Unlocking

Warning

1. Do not perform unlocking while an external force such as a load or spring force is being applied. This is very dangerous because the cylinder will move suddenly. Release the lock after preventing cylinder movement with a lifting device such as a jack.
2. After confirming safety, operate the manual release following the steps shown below. Carefully confirm that personnel are not inside the load movement range, etc., and that there is no danger even if the load moves suddenly.

Manually unlocking For $\phi 20$ to $\phi 32$

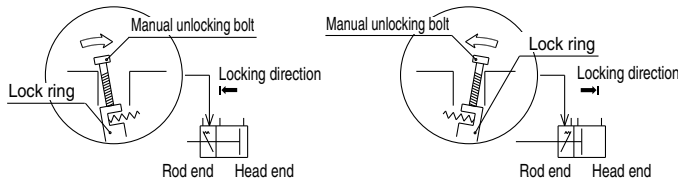

Extension locking

- 1) Remove the dust cover.
- 2) Screw a manual unlocking bolt (a bolt of M3 x 0.5 x 15 L or more commercially available) into the lock ring threads as shown above, and lightly push the bolt in the direction of the arrow (head end) to unlock.

Retraction locking

- 1) Remove the dust cover.
- 2) Screw a manual unlocking bolt (a bolt of M3 x 0.5 x 15 L or more commercially available) into the lock ring threads as shown above, and lightly push the bolt in the direction of the arrow (rod end) to unlock.

For $\phi 40$ to $\phi 100$

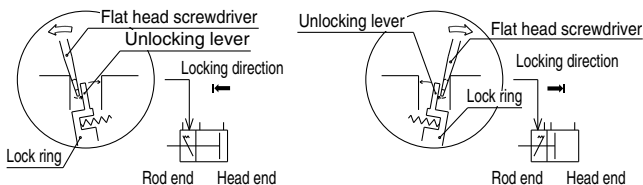

Extension locking

- 1) Remove the dust cover.
- 2) Insert a flat head screwdriver on the rod end of the manual unlocking lever as shown above, and lightly push the screwdriver in the direction of the arrow (rod end) to unlock.

Retraction locking

- 1) Remove the dust cover.
- 2) Insert a flat head screwdriver on the head end of the manual unlocking lever as shown above, and lightly push the screwdriver in the direction of the arrow (head end) to unlock.

Holding the Unlocked State ($\phi 20$ to $\phi 32$)

Caution

1. In order to hold the unlocked state, be sure to follow the steps below after confirming safety.
 - 1) Remove the dust cover [1].
 - 2) Supply air pressure of 0.2 MPa or more to the unlocking port [2] shown below to unlock.
 - 3) Screw the attached hexagon socket head cap bolt [3] ($\phi 20$, $\phi 25$: M3 x 0.5 x 5 L, $\phi 32$: M3 x 0.5 x 10 L), into the lock ring to hold the unlocked state.
2. To use the lock mechanism again, be sure to remove the unlocking bolt.

When the unlocking bolt is screwed in, the lock mechanism does not function. Remove the unlocking bolt according to the steps prescribed in the section of "Preparing for Operation."

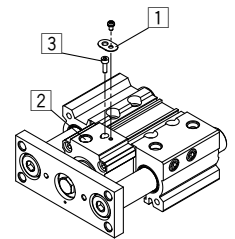

Maintenance

Caution

1. In order to maintain good performance, operate with clean unlubricated air. If lubricated air, compressor oil or drainage, etc., enter the cylinder, there is a danger of sharply reducing the locking performance.
2. Do not apply grease to the piston rod. There is a danger of sharply reducing the locking performance.
3. For $\phi 20$ to $\phi 32$, a $\phi 12$ silver seal is labeled on the one surface of the lock body (on the surface opposite from the unlocking port). The seal is meant for dust prevention, but even if it is peeled off, there would be no problem functionally.
4. Never disassemble the lock unit. It contains a heavy-duty spring which is dangerous and there is also a danger of reducing the locking performance.

Safety Instructions

These safety instructions are intended to prevent hazardous situations and/or equipment damage. These instructions indicate the level of potential hazard with the labels of “**Caution**,” “**Warning**” or “**Danger**.” They are all important notes for safety and must be followed in addition to International Standards (ISO/IEC)*1), and other safety regulations.

 **Caution:** **Caution** indicates a hazard with a low level of risk which, if not avoided, could result in minor or moderate injury.

 **Warning:** **Warning** indicates a hazard with a medium level of risk which, if not avoided, could result in death or serious injury.

 **Danger:** **Danger** indicates a hazard with a high level of risk which, if not avoided, will result in death or serious injury.

*1) ISO 4414: Pneumatic fluid power – General rules relating to systems.
ISO 4413: Hydraulic fluid power – General rules relating to systems.
IEC 60204-1: Safety of machinery – Electrical equipment of machines.
(Part 1: General requirements)
ISO 10218-1: Manipulating industrial robots – Safety.
etc.

Warning

1. The compatibility of the product is the responsibility of the person who designs the equipment or decides its specifications.

Since the product specified here is used under various operating conditions, its compatibility with specific equipment must be decided by the person who designs the equipment or decides its specifications based on necessary analysis and test results. The expected performance and safety assurance of the equipment will be the responsibility of the person who has determined its compatibility with the product. This person should also continuously review all specifications of the product referring to its latest catalog information, with a view to giving due consideration to any possibility of equipment failure when configuring the equipment.

2. Only personnel with appropriate training should operate machinery and equipment.

The product specified here may become unsafe if handled incorrectly. The assembly, operation and maintenance of machines or equipment including our products must be performed by an operator who is appropriately trained and experienced.

3. Do not service or attempt to remove product and machinery/equipment until safety is confirmed.

1. The inspection and maintenance of machinery/equipment should only be performed after measures to prevent falling or runaway of the driven objects have been confirmed.
2. When the product is to be removed, confirm that the safety measures as mentioned above are implemented and the power from any appropriate source is cut, and read and understand the specific product precautions of all relevant products carefully.
3. Before machinery/equipment is restarted, take measures to prevent unexpected operation and malfunction.

4. Contact SMC beforehand and take special consideration of safety measures if the product is to be used in any of the following conditions.

1. Conditions and environments outside of the given specifications, or use outdoors or in a place exposed to direct sunlight.
2. Installation on equipment in conjunction with atomic energy, railways, air navigation, space, shipping, vehicles, military, medical treatment, combustion and recreation, or equipment in contact with food and beverages, emergency stop circuits, clutch and brake circuits in press applications, safety equipment or other applications unsuitable for the standard specifications described in the product catalog.
3. An application which could have negative effects on people, property, or animals requiring special safety analysis.
4. Use in an interlock circuit, which requires the provision of double interlock for possible failure by using a mechanical protective function, and periodical checks to confirm proper operation.

Caution

1. The product is provided for use in manufacturing industries.

The product herein described is basically provided for peaceful use in manufacturing industries.
If considering using the product in other industries, consult SMC beforehand and exchange specifications or a contract if necessary.
If anything is unclear, contact your nearest sales branch.

Limited warranty and Disclaimer/ Compliance Requirements

The product used is subject to the following “Limited warranty and Disclaimer” and “Compliance Requirements”.

Read and accept them before using the product.

Limited warranty and Disclaimer

1. The warranty period of the product is 1 year in service or 1.5 years after the product is delivered, whichever is first.*2)
Also, the product may have specified durability, running distance or replacement parts. Please consult your nearest sales branch.
2. For any failure or damage reported within the warranty period which is clearly our responsibility, a replacement product or necessary parts will be provided.
This limited warranty applies only to our product independently, and not to any other damage incurred due to the failure of the product.
3. Prior to using SMC products, please read and understand the warranty terms and disclaimers noted in the specified catalog for the particular products.

*2) Vacuum pads are excluded from this 1 year warranty.

A vacuum pad is a consumable part, so it is warranted for a year after it is delivered.
Also, even within the warranty period, the wear of a product due to the use of the vacuum pad or failure due to the deterioration of rubber material are not covered by the limited warranty.

Compliance Requirements

1. The use of SMC products with production equipment for the manufacture of weapons of mass destruction (WMD) or any other weapon is strictly prohibited.
2. The exports of SMC products or technology from one country to another are governed by the relevant security laws and regulations of the countries involved in the transaction. Prior to the shipment of a SMC product to another country, assure that all local rules governing that export are known and followed.

Caution

SMC products are not intended for use as instruments for legal metrology.

Measurement instruments that SMC manufactures or sells have not been qualified by type approval tests relevant to the metrology (measurement) laws of each country. Therefore, SMC products cannot be used for business or certification ordained by the metrology (measurement) laws of each country.

Safety Instructions

Be sure to read the “Handling Precautions for SMC Products” (M-E03-3) and “Operation Manual” before use.