

Guide Cylinder/Compact Type

MGC Series

ø20, ø25, ø32, ø40, ø50

Integration of guide rods and a base cylinder

Air cushion is standard.

Enables the impact to be absorbed at the stroke end when the cylinder is operated at high speeds.

Space-saving

Length **20%** shorter
Height **18%** shorter
(In comparison with MGG□B32)

Lightweight

Weight **32%** reduction
(In comparison with MGGLB32-100)

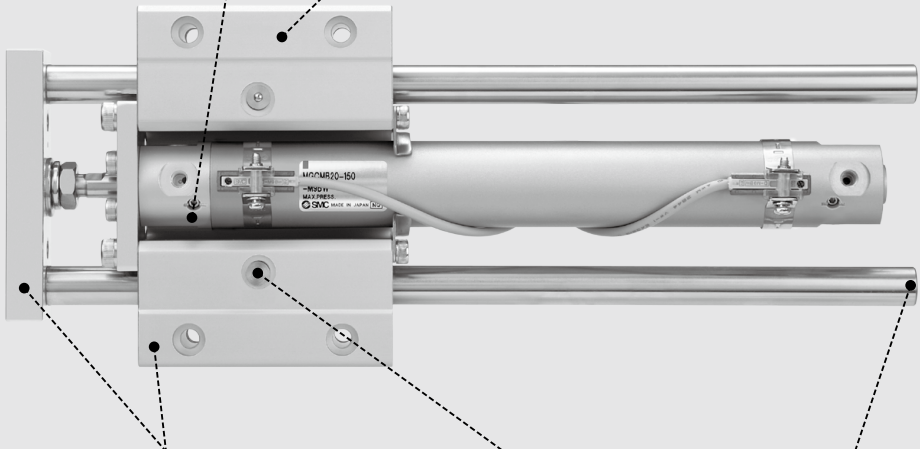

Compact guide body and front plate

Grease nipple offers easy lubrication for bearings.

Models without rear plate are available.

MGJ

JMGP

MGP

MGPW

MGQ

MGG

MGC

MGF

MGZ

MGT

Variations

Bore size (mm)	Standard stroke (mm)						
	75	100	125	150	200	250	300
20	●	●	●	●	●	●	●
25	●	●	●	●	●	●	●
32	●	●	●	●	●	●	●
40	●	●	●	●	●	●	●
50	●	●	●	●	●	●	●

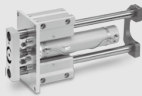

Long stroke

Bore size (mm)	Long stroke (mm)										
	250	300	350	400	450	500	600	700	800	900	1000
20	●	●	●	●	●	●	●	●	●	●	●
25	●	●	●	●	●	●	●	●	●	●	●
32	●	●	●	●	●	●	●	●	●	●	●
40	●	●	●	●	●	●	●	●	●	●	●
50	●	●	●	●	●	●	●	●	●	●	●



D-□

-X□

Guide Cylinder/Compact Type

MGC Series

ø20, ø25, ø32, ø40, ø50

How to Order

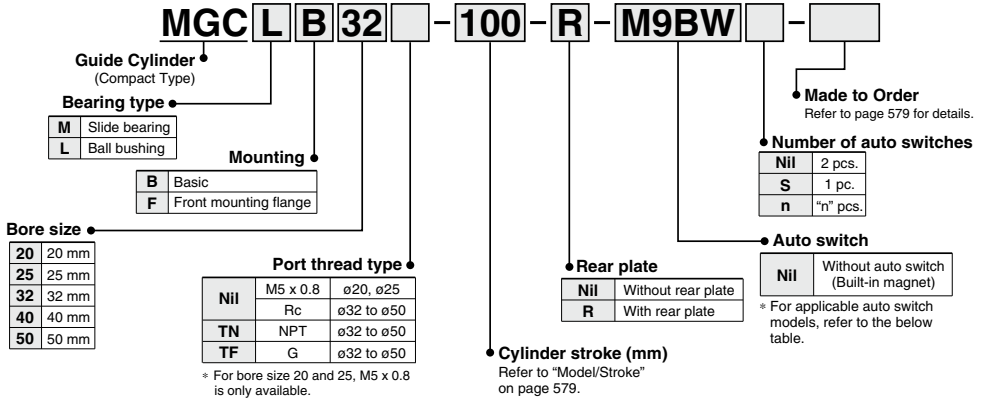

Applicable Auto Switches/Refer to pages 1119 to 1245 for further information on auto switches.

Type	Special function	Electrical entry	Indicator/light	Wiring (Output)	Load voltage		Auto switch model				Lead wire length (m)					Pre-wired connector	Applicable load				
					DC	AC	Applicable bore size				0.5 (Nil)	1 (M)	3 (L)	5 (Z)	None (N)						
							ø20 to ø50 Perpendicular	ø20, ø25	ø32	ø40, ø50											
Solid state auto switch	—	Grommet	—	3-wire (NPN)	5V, 12V	—	M9NV	M9N	●	●	○	—	○	IC circuit	Relay, PLC						
				3-wire (PNP)			M9PV	M9P	●	●	○	—	○								
		Connector	—	2-wire	12V	—	M9BV	M9B	●	●	○	—	○	—							
				—			H7C	●	—	●	●	—	—								
	Diagnostic indication (2-color indicator)	Grommet	Yes	3-wire (NPN)	5V, 12V	—	M9NV	M9N	●	●	○	—	○	IC circuit							
				3-wire (PNP)			M9PV	M9P	●	●	○	—	○								
		Connector	—	2-wire	12V	—	M9BV	M9B	●	●	○	—	○	—							
				—			H7C	●	—	●	●	—	—								
		Grommet	—	3-wire (NPN)	5V, 12V	—	M9NV	M9N	○	○	●	○	—	○		IC circuit					
				3-wire (PNP)			M9PV	M9P	○	○	●	○	—	○							
Connector	—	2-wire	12V	—	M9BV	M9B	○	○	●	○	—	○	—								
		—			H7C	○	○	●	○	—	○										
Grommet	Yes	—	4-wire (NPN)	5V, 12V	—	M9NV	M9N	●	—	●	○	—	○	IC circuit							
			—			H7NF	●	—	●	○	—	○									
Reed auto switch	—	Grommet	Yes	3-wire (NPN equivalent)	5V	—	A96V	A96	●	—	●	—	—	—	IC circuit	Relay, PLC					
				None			2-wire	24V	12V	—	100V	A93V*2	A93	●	●		●	—	—	—	
											100V or less	A90V	A90	●	—		●	—	—	—	IC circuit
											100V, 200V	—	(B54)	B54	●		—	●	—	—	—
											200V or less	—	(B64)	B64	●		—	●	—	—	—
		Connector	—	—	—	—	—	—	C73C	●	—	●	●	—	—		—				
								—	C80C	●	—	●	●	—	—		IC circuit				
								24V or less	—	—	—	—	—	—	—		—	—	—		
								—	(B59W)	B59W	●	—	●	—	—		—	—	—		
								—	—	—	—	—	—	—	—		—	—	—		

*1 Water resistant type auto switches can be mounted on the above models, but in such case SMC cannot guarantee water resistance.

Consult with SMC regarding water resistant types with the above model numbers.

*2 1 m type lead wire is only applicable to D-A93.

* Lead wire length symbols: 0.5 m Nil (Example) M9NV
1 m M (Example) M9NWM
3 m L (Example) M9NWL
5 m Z (Example) M9NWX
None N (Example) H7CN

* Solid state auto switches marked with "○" are produced upon receipt of order.

* Since there are other applicable auto switches than listed, refer to page 591 for details.

* For details about auto switches with pre-wired connector, refer to pages 1192 and 1193.

* The D-A9□(V)/M9□(V)/M9□W(V)/M9□A(V) are shipped together, (but not assembled).

(Only switch mounting brackets are assembled at the time of shipment.)

Caution

When using auto switches shown inside (), stroke end detection may not be possible depending on the One-touch fitting or speed controller model. Please contact SMC in this case.

Model/Specifications

Model/Stroke

Model (Bearing type)	Bore size (mm)	Standard stroke (mm)	Long stroke (mm)
MGCM (Slide bearing)	20	75, 100, 125, 150, 200	250, 300, 350, 400
	25		350, 400, 450, 500
	32		350, 400, 450, 500, 600
MGCL (Ball bushing)	40	75, 100, 125, 150 200, 250, 300	350, 400, 450, 500, 600 700, 800
	50		350, 400, 450, 500, 600 700, 800, 900, 1000

* Intermediate strokes and short strokes other than the above are produced upon receipt of order.

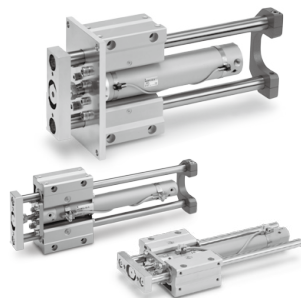

Symbol
Air cushion

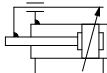

Made to Order: Individual Specifications
(For details, refer to page 593.)

Symbol	Specifications
-X440	With piping ports for grease

Made to Order

[Click here for details](#)

Symbol	Specifications
-XB6	Heat resistant cylinder (-10 to 150°C)
-XB13	Low speed cylinder (5 to 50 mm/s)
-XC4	With heavy duty scraper
-XC6□	Made of stainless steel
-XC8	Adjustable stroke cylinder/Adjustable extension type
-XC9	Adjustable stroke cylinder/Adjustable retraction type
-XC11	Dual stroke cylinder/Single rod
-XC13	Auto switch rail mounting type
-XC22	Fluororubber seal
-XC35	With coil scraper
-XC37	Larger throttle diameter of connecting port
-XC56	With knock pin holes
-XC73	Built-in cylinder with lock (CDNG)
-XC74	With front plate for MGGM
-XC78	Auto switch mounting special dimensions at stroke end
-XC79	Tapped hole, drilled hole, pin hole machined additionally

Specifications

Model	MGCM20	MGCM25	MGCM32	MGCM40	MGCM50	
Base cylinder	CDG1ZA Bore size Port thread type Stroke Z- Auto switch					
Bore size (mm)	20	25	32	40	50	
Action	Double acting					
Fluid	Air					
Proof pressure	1.5 MPa					
Maximum operating pressure	1.0 MPa					
Minimum operating pressure	0.15 MPa (Horizontal, No load)					
Ambient and fluid temperature	-10 to 60°C					
Piston speed	50 to 750 mm/s					
Cushion	Air cushion					
Base cylinder lubrication	Non-lube					
Stroke length tolerance	+1.9 +0.2 mm					
Non-rotating accuracy ^{*1}	Slide bearing	±0.07°	±0.06°	±0.06°	±0.05°	±0.04°
	Ball bushing	±0.06°	±0.05°	±0.04°	±0.04°	±0.04°
Piping port size (Rc, NPT, G) ^{*2}	M5 x 0.8			1/8	1/4	

*1 When the cylinder is retracted (initial value), the non-rotating accuracy without loads or deflection of the guide rods will be below the values shown in the above table as a guideline.

*2 For bore sizes 20 and 25, M5 x 0.8 is only available.

Theoretical Output

Bore size (mm)	Rod size (mm)	Operating direction	Piston area (mm ²)	Operating pressure (MPa)								
				0.2	0.3	0.4	0.5	0.6	0.7	0.8	0.9	1.0
				OUT	IN	OUT	IN	OUT	IN	OUT	IN	OUT
20	8	OUT	314	62.8	94.2	126	157	188	220	251	283	314
		IN	264	52.8	79.2	106	132	158	185	211	238	264
25	10	OUT	491	98.2	147	196	246	295	344	393	442	491
		IN	412	82.4	124	165	206	247	288	330	371	412
32	12	OUT	804	161	241	322	402	482	563	643	724	804
		IN	691	138	207	276	346	415	484	553	622	691
40	16	OUT	1260	252	378	504	630	756	882	1010	1130	1260
		IN	1060	212	318	424	530	636	742	848	954	1060
50	20	OUT	1960	392	588	784	980	1180	1370	1570	1760	1960
		IN	1650	330	495	660	825	990	1160	1320	1490	1650

Note) Theoretical output (N) = Pressure (MPa) x Piston area (mm²)

MGJ

JMGF

MGF

MGPM

MGQ

MGG

MGK

MGF

MGZ

MGT

D-□

-X□

Weight

Bore size (mm)		20	25	32	40	50
Basic weight	LB type (Ball bushing bearing/Basic)	1.04	1.55	2.07	3.32	6.45
	LF type (Ball bushing bearing/Front mounting flange)	1.7	2.35	3.02	5.02	8.58
	MB type (Slide bearing/Basic)	1.02	1.51	2.03	3.26	6.35
	MF type (Slide bearing/Front mounting flange)	1.69	2.32	2.98	4.96	8.48
Additional weight with rear plate		0.2	0.25	0.34	0.58	1.04
Additional weight per each 50 mm of stroke		0.14	0.17	0.25	0.4	0.61
Additional weight for long stroke		0.01	0.01	0.02	0.03	0.06
Additional weight with bracket		0.011	0.018	0.019	0.031	0.061

(kg)

Calculation: (Example)

MGCLB32-500-R

(Ball bushing bearing/Basic, ø32/500 st., with rear plate, with bracket)

- Basic weight 2.07 (LB type)
- Additional weight with rear plate 0.34
- Additional stroke weight 0.25/50 st
- Stroke 500 st
- Additional weight for long stroke 0.02
- Additional weight with bracket 0.019

$$2.07 + 0.34 + 0.25 \times 500/50 + 0.02 + 0.019 = 4.95 \text{ kg}$$

Moving Parts Weight

Bore size (mm)	20	25	32	40	50
Moving parts basic weight	0.34	0.53	0.69	1.2	2.45
Additional weight with rear plate	0.2	0.25	0.34	0.58	1.04
Additional weight per each 50 mm of stroke	0.11	0.14	0.2	0.33	0.51

(kg)

Calculation: (Example)

MGCLB32-500-R

- Moving parts basic weight 0.69
- Additional weight with rear plate 0.34
- Additional stroke weight 0.2/50 st.
- Stroke 500 st.

$$0.69 + 0.34 + 0.2 \times 500/50 = 3.03 \text{ kg}$$

Allowable Kinetic Energy by Air Cushion Mechanism

Bore size (mm)	Effective cushion length (mm)	R: Rod end, H: Head end	
		Allowable kinetic energy (J)	
20	R: 7, H: 7.5	R: 0.35, H: 0.42	
25	R: 7, H: 7.5	R: 0.56, H: 0.65	
32	7.5	0.91	
40	8.7	1.8	
50	11.8	3.4	

High kinetic energy generated by large loads and high speed operations can be absorbed by compressing air at the stroke end thus preventing shock and vibration being transmitted to the machine. The air cushion has not been designed to control the piston speed in the end regions of the stroke. The load kinetic energy can be obtained by the following equation:



$$E_k = \frac{M + m}{2} U^2 \quad U = 1.4 U_a$$

- Ek: Kinetic energy (J)
- M: Weight of the driven object (kg)
- m: Weight of moving parts of cylinder (kg)
- U: Maximum speed (m/s)
- Ua: Average speed (m/s)

Note) Set Ua so that rush speed into cushion U should not exceed 0.75 m/s.

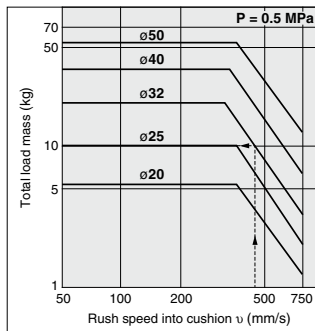

Also, selection can be made by using the graph above.

Example)

Find the maximum load mass when using a cylinder with ø32, stroke 500 mm, with rear plate as a lifter at an average speed of Ua 300 mm/s.

Rush speed into cushion U is as follows:

$$U = 1.4 \times 300 = 420 \text{ mm/s.}$$

Extend upward from 420 mm/s on the abscissa in the graph until crossing at the line of bore size 32. Extend leftward from the intersection to find the total load weight 10 kg.

Subtract the moving parts weight of 3.08 kg from this. (For moving parts, refer to "Moving Parts Weight".) 6.92 kg will be obtained, which is equal to the maximum load weight.

⚠ Caution

In a horizontal application, pay attention to that the load weight should not exceed the allowable end load given on pages 582 to 585.

Air-hydro

Low pressure hydraulic cylinder of 1.0 MPa or less
 Through the concurrent use of the CC series air-hydro unit, it becomes possible to operate at a constant or low speed or to effect an intermediate stop, just like a hydraulic unit, while using pneumatic equipment such as a valve.

MGCH Bearing type Mounting Bore size - Stroke - With/Without rear plate
 ↓
 Air-hydro

Specifications

Bore size (mm)	20, 25, 32, 40, 50
Action	Double acting
Fluid	Turbine oil
Proof pressure	1.5 MPa
Maximum operating pressure	1.0 MPa
Minimum operating pressure	0.18 MPa (Horizontal, No load)
Piston speed	15 to 300 mm/s
Cushion	None
Ambient and fluid temperature	+5 to 60°C
Mounting	Basic Front mounting flange

* For specifications other than the above, refer to page 579.

* Auto switch can be mounted.

Dimensions (Dimensions other than the below are the same as standard type.)

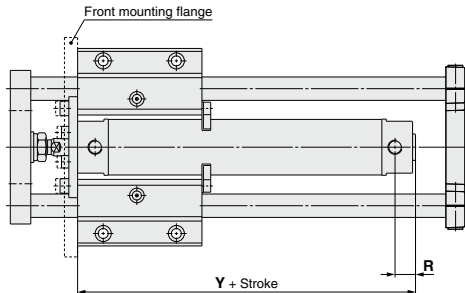

(mm)		
Bore size (mm)	R	Y
20	14	79
25	14	79
32	14	81
40	15	89
50	16	104

Series Applicable to Operating Environments that Do Not Accept Copper

- Copper and Fluorine-free ... 20 series
- * For details, refer to the SMC website.

- MGJ
- JMGP
- MGP
- MGPW
- MGQ
- MGG
- MGC
- MGF
- MGZ
- MGT

- D-□
- X□

MGC Series

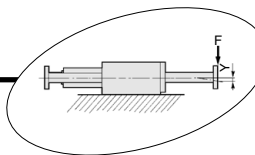

Slide Bearing Allowable End Load and Deflection

MGCM -Stroke-R

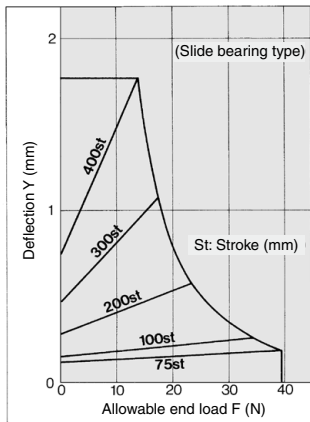

MGCM -Stroke-R

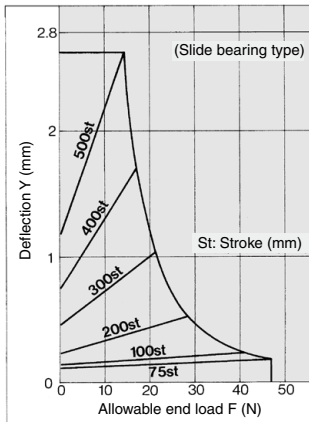

MGCM -Stroke-R

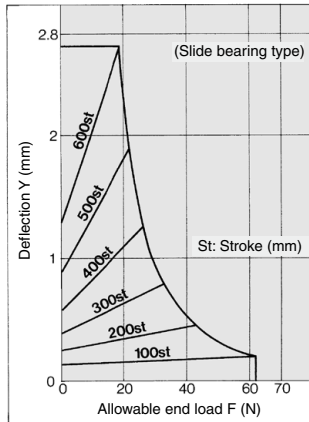

MGCM -Stroke-R

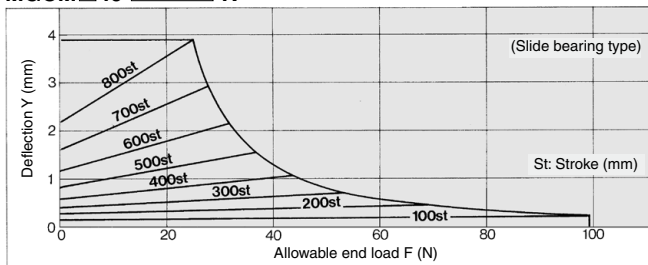

MGCM -Stroke-R

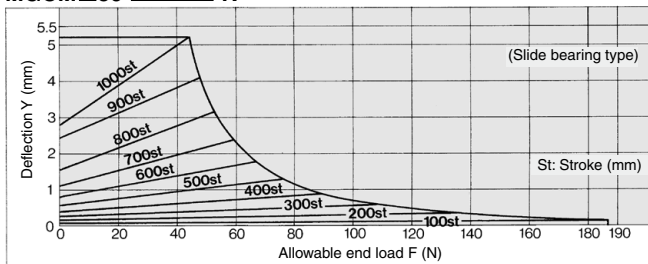

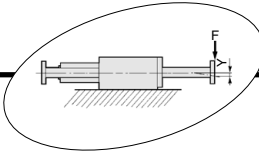

**Ball Bushing Bearing
Allowable End Load and Deflection**

MGCL□20-Stroke-R

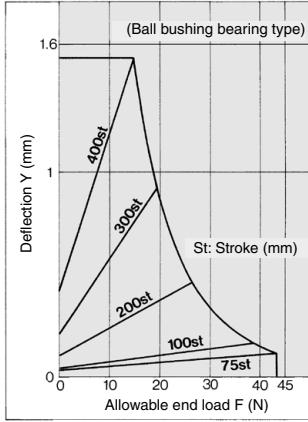

MGCL□25-Stroke-R

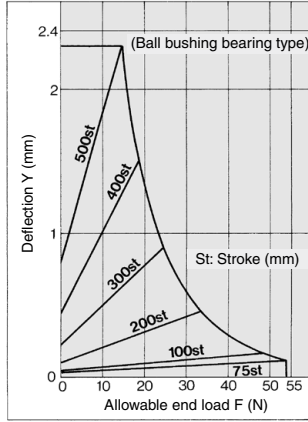

MGCL□32-Stroke-R

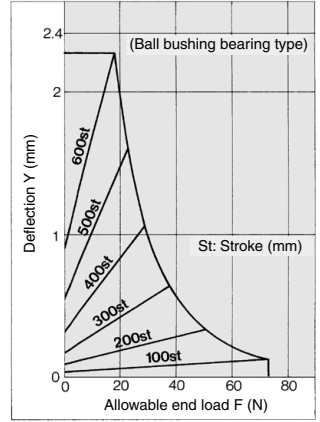

MGCL□40-Stroke-R

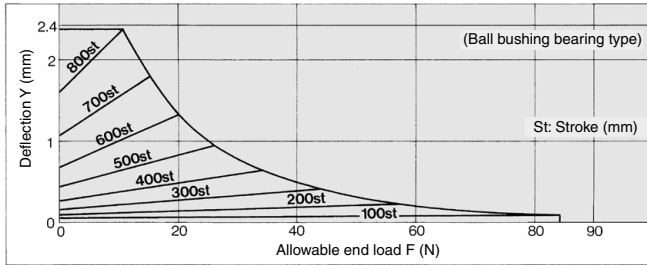

MGCL□50-Stroke-R

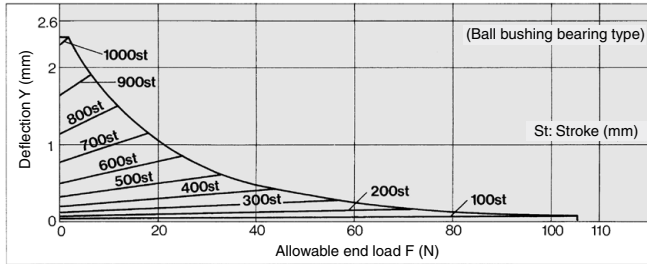

MGJ

JMGP

MGP

MGPW

MGQ

MGG

MGC

MGF

MGZ

MGT

D-□

-X□

MGC Series

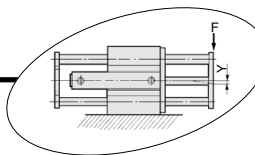

Slide Bearing Allowable End Load and Deflection

MGCM -Stroke-R

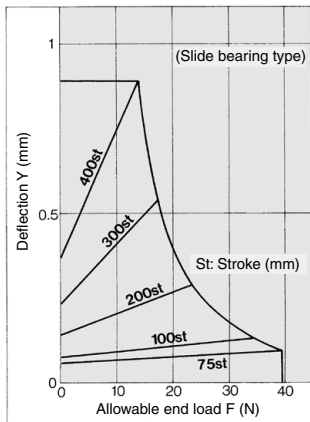

MGCM -Stroke-R

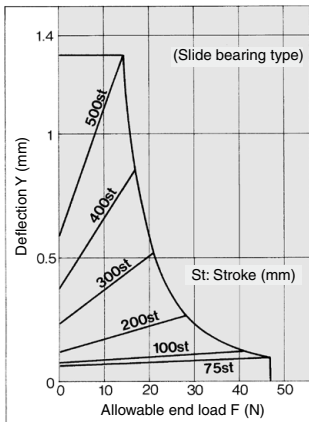

MGCM -Stroke-R

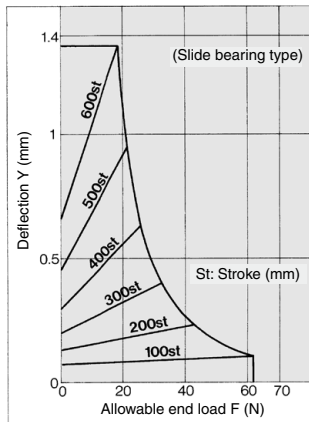

MGCM -Stroke-R

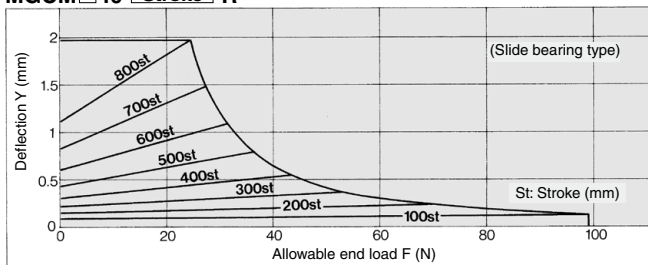

MGCM -Stroke-R

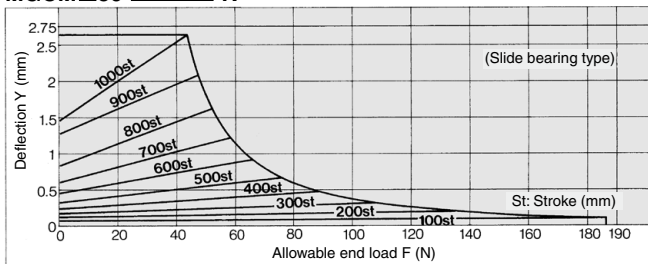

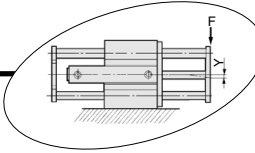

**Ball Bushing Bearing
Allowable End Load and Deflection**

MGCL □ **20** - **Stroke** - **R**

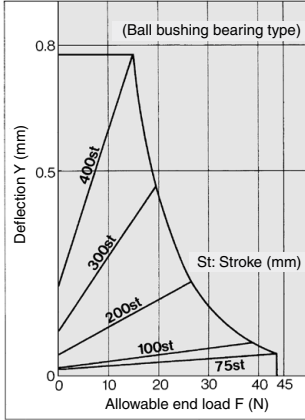

MGCL □ **25** - **Stroke** - **R**

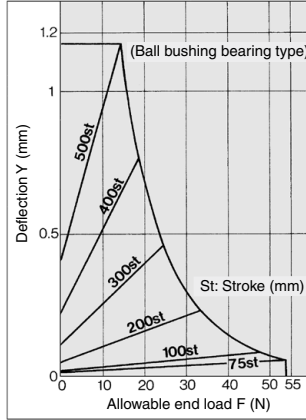

MGCL □ **32** - **Stroke** - **R**

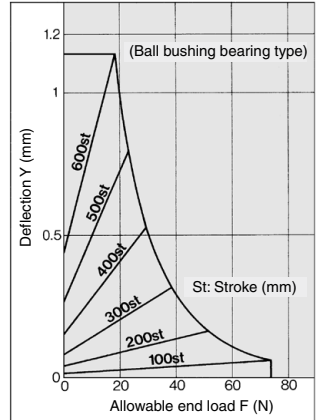

MGCL □ **40** - **Stroke** - **R**

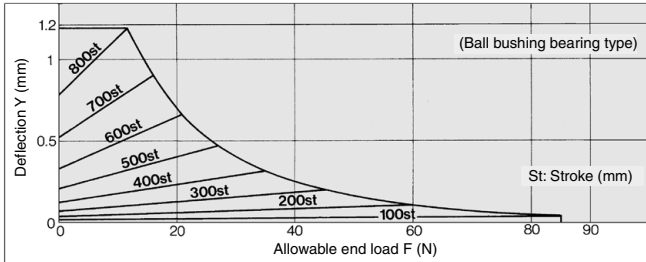

MGCL □ **50** - **Stroke** - **R**

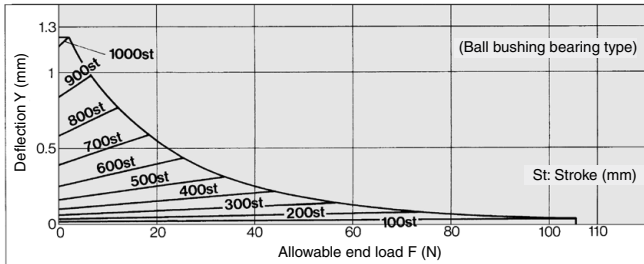

- MGJ
- JMGP
- MGP
- MGPW
- MGQ
- MGG
- MGC
- MGF
- MGZ
- MGT

- D-□
- X□

Allowable Eccentric Load

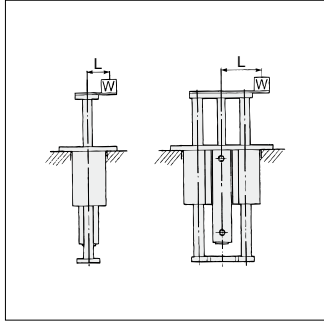

Slide Bearing/
MGCM□□-Stroke-R

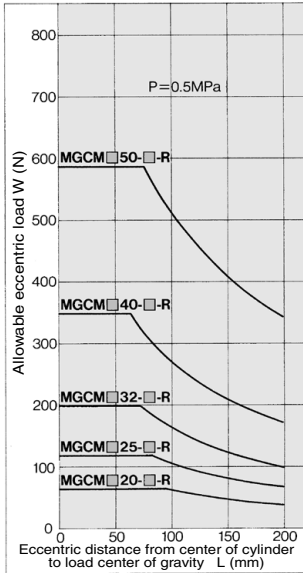

(Set the maximum allowable load so that it does not exceed the following percentages of the theoretical output: 40% for ø20, 50% for ø25 and ø32, 55% for ø40 and 60% or less for ø50, respectively.)

Ball Bushing Bearing/
MGCL□□-Stroke-R

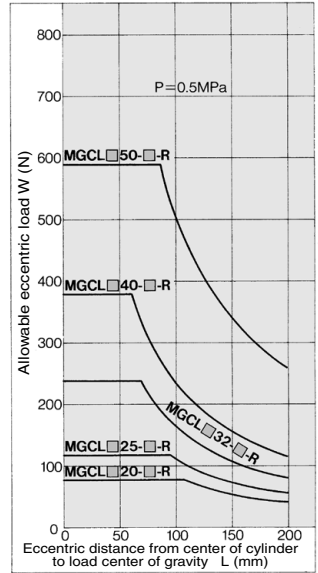

(Set the maximum allowable load so that it does not exceed the following percentages of the theoretical output: 40% for ø20, 50% for ø25 and ø32, 55% for ø40 and 60% or less for ø50, respectively.)

Construction: With Rear Plate

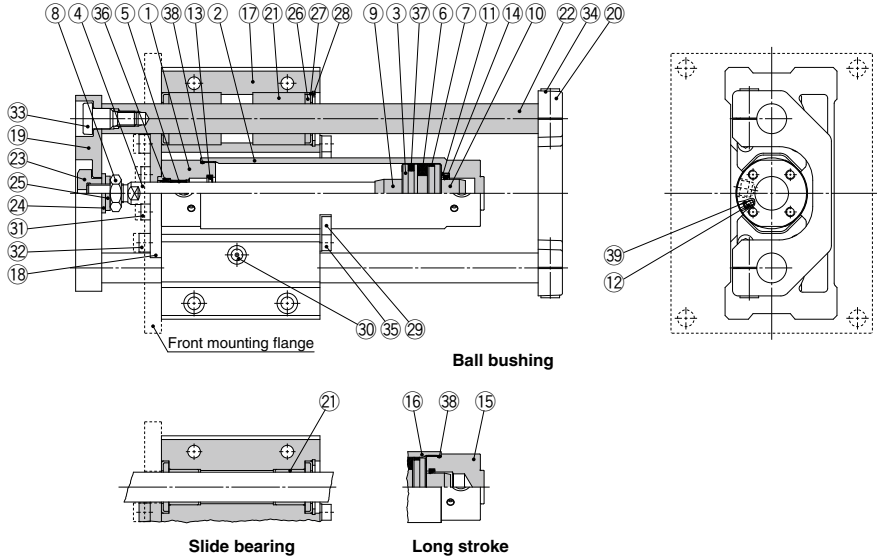

Component Parts

No.	Description	Material	Note
1	Rod cover	Aluminum alloy	Hard anodized
2	Tube cover	Aluminum alloy	Hard anodized
3	Piston	Aluminum alloy	
4	Piston rod	Stainless steel	For $\phi 20, \phi 25$
		Carbon steel	Hard chrome plating For $\phi 32$ to $\phi 50$
5	Bushing	Bearing alloy	
6	Magnet	—	
7	Wear ring	Resin	
8	Rod end nut	Carbon steel	Zinc chromated
9	Cushion ring A	Aluminum alloy	
10	Cushion ring B	Aluminum alloy	
11	Seal retainer	Carbon steel	Zinc chromated
12	Cushion valve	Carbon steel	Electroless nickel plating For $\phi 20$ to $\phi 40$
		Carbon steel	Zinc chromated For $\phi 50$
13	Cushion seal A	Urethane	$\phi 32$ or larger is common.
14	Cushion seal B	Urethane	
15	Head cover	Aluminum alloy	Hard anodized For long stroke
16	Cylinder tube	Aluminum alloy	Hard anodized
17	Guide body	Aluminum alloy	Anodized
18	Small flange	Carbon steel	Nickel plating For basic
18	Large flange	Carbon steel	Nickel plating For front mounting flange
19	Front plate	Carbon steel	Nickel plating
20	Rear plate	Cast iron	Painted
21	Slide bearing	Bearing alloy	For slide bearing
21	Ball bushing	—	For ball bushing
22	Guide rod	Carbon steel	Hard chrome plating For slide bearing
		Carbon steel	Quenched, hard chrome plating For ball bushing
23	End bracket	Carbon steel	Nickel plating
24	Flat washer	Carbon steel	Zinc chromated
25	Spring washer	Carbon steel	Zinc chromated
26	Felt	Felt	
27	Holder	Stainless steel	
28	Type C Retaining ring for hole	Carbon tool steel	Phosphate coated
29	Bracket	Stainless steel	
30	Nipple	—	Nickel plating
31	Hexagon socket head cap screw	Carbon steel	Zinc chromated For cylinder mounting
32	Hexagon socket head cap screw	Carbon steel	Zinc chromated For large/small flange mounting

Component Parts

No.	Description	Material	Note
33	Guide bolt	Carbon steel	Nickel plating For front plate mounting
34	Hexagon socket head cap screw	Carbon steel	Zinc chromated For rear plate mounting
35	Hexagon socket head cap screw	Carbon steel	Zinc chromated For bracket mounting
36	Rod seal	NBR	
37	Piston seal	NBR	
38	Tube gasket	NBR	
39	Valve seal	NBR	

Replacement Parts/Seal Kit

Bore size (mm)	Kit no.	Contents
20	CG1N20Z-PS	Set of nos. above 36, 37, 38
25	CG1N25Z-PS	
32	CG1N32Z-PS	
40	CG1N40Z-PS	

Note) Refer to the following precautions for disassembly/replacement. Order with the kit number according to the bore size.
 * Seal kit includes a grease pack (10 g). Order with the following part number when only the grease pack is needed.
 Grease pack part number: GR-S-010 (10 g)

⚠ Caution

- Do not replace the bushings.
- To replace a seal, apply grease to the new seal before installing it. If the cylinder is put into operation without applying grease to the seal, it could cause the seal to wear significantly, leading to premature air leakage.
- Basic cylinders with a bore size of $\phi 50$ cannot be disassembled. When disassembling cylinders with bore sizes of $\phi 20$ through $\phi 40$, grip the double flat part of either the tube cover or the rod cover with a vise and loosen the other side with a wrench or a monkey wrench etc., and then remove the cover. When retightening, tighten approximately 2 degrees more than the original position. (Cylinders with bore size $\phi 50$ are tightened with a large tightening torque and cannot be disassembled. If disassembly is required, please contact SMC.)

MGJ

JMGF

MGP

MGPW

MGQ

MGG

MGC

MGF

MGZ

MGT

D-□

-X□

MGC Series

Dimensions

Basic: With rear plate

MGC□B□□□-□-**R**

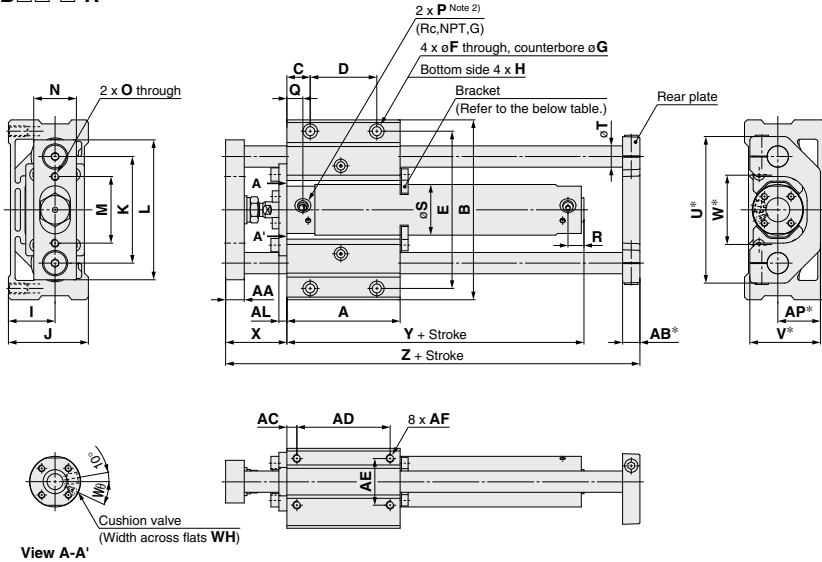

View A-A'

Bore size (mm)	Stroke range (mm)	A	AA	AB*	AC	AD	AE	AF	AL	AP*	B	C	D	E	F	G	H
20	75, 100, 125, 150, 200	75	11	13	6.5	62	25	M5 x 0.8 depth 10	6	22	106	15	45	90	5.4	9.5 depth 6	M6 x 1 depth 10
25	75, 100, 125, 150, 200, 250, 300	80	14	13	7.5	65	30	M6 x 1 depth 12	6	27	120	17.5	45	103	6.8	11 depth 8	M8 x 1.25 depth 14
32		85	14	13	7.5	70	35	M6 x 1 depth 12	6	32	135	17.5	50	118	6.8	11 depth 8	M8 x 1.25 depth 14
40		95	17	16	10	75	40	M8 x 1.25 depth 16	9	37	160	22.5	50	140	8.6	14 depth 10	M10 x 1.5 depth 18
50		130	23	19	10	110	45	M10 x 1.5 depth 20	9	42	194	25	80	170	10.5	17 depth 12	M12 x 1.75 depth 21

Bore size (mm)	I	J	K	L	M	N	O	P Note 2)	Rc, NPT port	G port	R	S	T	U*	V*	W*	WH	W ϕ	X	Y	Z
									Q	Q											
20	25	44	60	80	38	25	M6 x 1	M5 x 0.8	12	12	12	26	12	86	40	36	1.5	25°	39	71	140
25	30	52	70	95	46	32	M6 x 1	M5 x 0.8	12.5	12.5	12	31	13	98	47	44	1.5	25°	46	71	153
32	35	60	80	105	50	32	M6 x 1	1/8	12	10.5	12	38	16	112	53	50	1.5	25°	46	73	161
40	40	70	95	125	60	38	M8 x 1.25	1/8	13	13	12	47	20	132	63	60	1.5	20°	56	80	188
50	45	82.5	115	150	75	50	M8 x 1.25	1/4	14	14	14	58	25	162	73	70	3	20°	67	92	241

Without Rear Plate

Long Stroke

Bracket Mounting Stroke

Bore size (mm)	Z
20	119
25	131
32	136
40	156
50	202

Bore size (mm)	Stroke range (mm)	Rc, NPT port	G port	Y
		R	R	
20	250 to 400	14	14	79
25	350 to 500	14.5	14.5	79
32	350 to 600	14	12.5	81
40	350 to 800	15	12	89
50	350 to 1000	16	16	104

Bore size (mm)	Bracket mounting stroke
20	100 st or more
25	125 st or more
32	150 st or more
40	200 st or more
50	250 st or more

Note 1) Dimensions marked with "*" are not required for without rear plate.

Note 2) For bore size 20 and 25, M5 x 0.8 is only available. Rc, NPT and G ports are available for bore size 32 or greater.

Dimensions

Front mounting flange: With rear plate

MGC□F□□□□-R

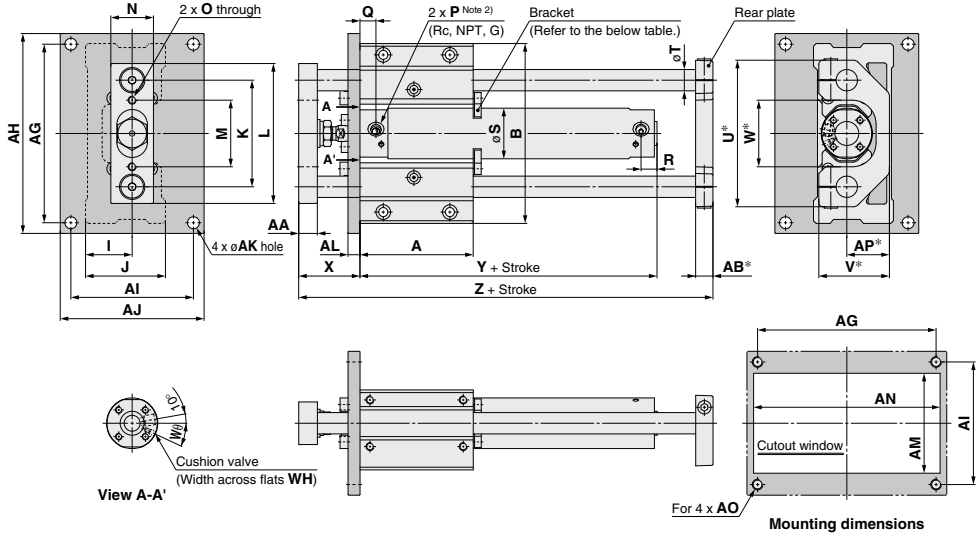

- MGJ
- JMGP
- MGP
- MGPW
- MGQ
- MGG
- MGC**
- MGF
- MGZ
- MGT

Bore size (mm)	Stroke range (mm)	(mm)																			
		A	AA	AB*	AG	AH	AI	AJ	AK	AL	AM	AN	AO	AP*	B	I	J	K	L	M	N
20	75, 100, 125, 150, 200	75	11	13	105	120	75	90	6.6	9	55	110	M6	22	106	25	44	60	80	38	25
25	75, 100, 125, 150 200, 250, 300	80	14	13	120	136	84	100	9	9	65	125	M8	27	120	30	52	70	95	46	32
32		85	14	13	134	150	92	108	9	9	75	140	M8	32	135	35	60	80	105	50	32
40		95	17	16	160	176	110	125	9	12	85	165	M8	37	160	40	70	95	125	60	38
50		130	23	19	190	210	115	135	11	12	95	200	M10	42	194	45	82.5	115	150	75	50

Bore size (mm)	O	P ^{Note 2)}	Rc, NPT port		G port		R	S	T	U*	V*	W*	WH	W θ	X	Y	Z
			Q	Q	Q	Q											
20	M6 x 1	M5 x 0.8	12	12	12	26	12	86	40	36	1.5	25°	39	71	140		
25	M6 x 1	M5 x 0.8	12.5	12.5	12	31	13	98	47	44	1.5	25°	46	71	153		
32	M6 x 1	1/8	12	10.5	12	38	16	112	53	50	1.5	25°	46	73	161		
40	M8 x 1.25	1/8	13	13	12	47	20	132	63	60	1.5	20°	56	80	188		
50	M8 x 1.25	1/4	14	14	14	58	25	162	73	70	3	20°	67	92	241		

Without Rear Plate

Long Stroke

Bracket Mounting Stroke

Bore size (mm)	Z
20	119
25	131
32	136
40	156
50	202

Bore size (mm)	Stroke range (mm)	Rc, NPT port		G port		Y
		R	R	R	R	
20	250 to 400	14	14	14	79	
25	350 to 500	14.5	14.5	79		
32	350 to 600	14	12.5	81		
40	350 to 800	15	12	89		
50	350 to 1000	16	16	104		

Bore size (mm)	Bracket mounting stroke
20	100 st or more
25	125 st or more
32	150 st or more
40	200 st or more
50	250 st or more

Note 1) Dimensions marked with "*" are not required for without rear plate.

Note 2) For bore size 20 and 25, M5 x 0.8 is only available. Rc, NPT and G ports are available for bore size 32 or greater.

- D-□
- X□

Auto Switch Mounting

Auto Switch Proper Mounting Position (Detection at Stroke End) and Its Mounting Height

D-M9□, M9□W
D-M9□A

D-A9□

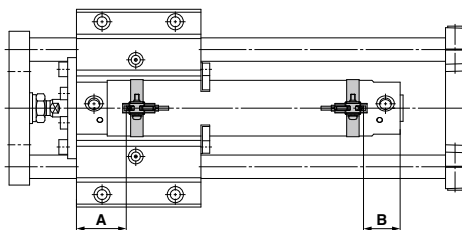
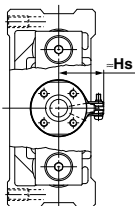

D-M9□V, M9□WV
D-M9□AV

D-A9□V

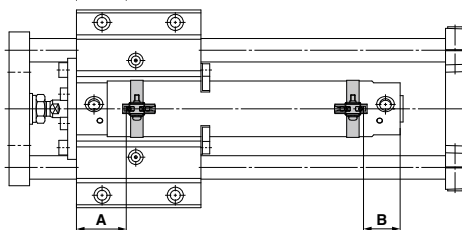
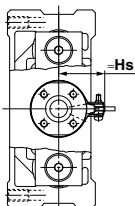

D-H7□, H7□W
D-H7NF, H7BA
D-H7C

D-B5, B6, B59W

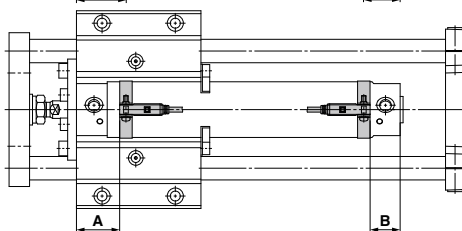
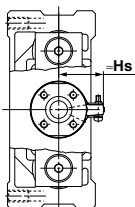

D-G5, K5, G5□W, G5BA
D-K59W
D-G59F
D-G5NT

D-C7, C8
D-C73C, C80C

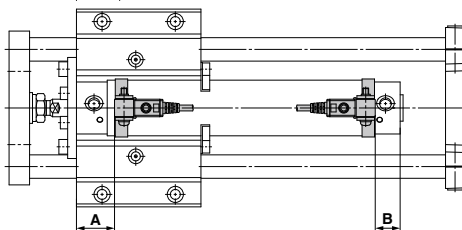
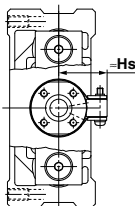

Auto Switch Proper Mounting Position

Auto switch model	(mm)													
	D-M9□(V) D-M9□W(V) D-M9□A(V)		D-A9□(V)		D-C7□ D-C80 D-C73C D-C80C		D-B5□ D-B64		D-B59W		D-H7□W D-H7BA D-H7□ D-H7C D-H7NF		D-G59F D-G5□W D-K59W D-G5BA D-G5□ D-K59 D-G5NT	
	A	B	A	B	A	B	A	B	A	B	A	B	A	B
20	33	24 (32)	29	20 (28)	29.5	20.5 (28.5)	23.5	14.5 (22.5)	26.5	17.5 (25.5)	28.5	19.5 (27.5)	25	16 (24)
25	33.5	24.5 (32.5)	28.5	20.5 (28.5)	29	21 (29)	23	15 (23)	26	18 (26)	28	20 (28)	24.5	16.5 (24.5)
32	34	25 (33)	30	21 (29)	30.5	21.5 (29.5)	24.5	15.5 (23.5)	27.5	18.5 (26.5)	29.5	20.5 (28.5)	26	17 (25)
40	39	27 (36)	35	23 (32)	35.5	23.5 (32.5)	29.5	17.5 (26.5)	32	20.5 (29.5)	34.5	22.5 (31.5)	31	19 (28)
50	46	32 (44)	42	28 (40)	42.5	28.5 (40.5)	36.5	22.5 (34.5)	39.5	25.5 (37.5)	41.5	27.5 (39.5)	38	24 (36)

Auto Switch Mounting Height

Auto switch model	(mm)			
	D-M9□V D-M9□WV D-M9□AV D-A9□V		D-C73C D-C80C	
	Hs	Hs	Hs	Hs
20	25.5	24.5	27	27.5
25	28	27	29.5	30
32	31.5	30.5	33	33.5
40	36	35	37.5	38
50	41.5	40.5	43	43.5

* (): Values for long stroke, double rod

Note) Adjust the auto switch after confirming the operating conditions in the actual setting.

Minimum Auto Switch Mounting Stroke

Auto switch model	n: No. of auto switches (mm)		
	1 pc.	No. of auto switches mounted	
		2 pcs. Same surface	"n" pcs. Same surface
D-M9□	5	40 ^{Note 1)}	55 + 35 (n-2) (n = 2, 3, 4, 5...)
D-M9□W	10	40 ^{Note 1)}	55 + 35 (n-2) (n = 2, 3, 4, 5...)
D-M9□A	10	40 ^{Note 1)}	60 + 35 (n-2) (n = 2, 3, 4, 5...)
D-A9□	5	30 ^{Note 1)}	50 + 35 (n-2) (n = 2, 3, 4, 5...)
D-M9□V	5	35	35 + 35 (n-2) (n = 2, 3, 4, 5...)
D-A9□V	5	25	25 + 35 (n-2) (n = 2, 3, 4, 5...)
D-M9□VV D-M9□AV	10	35	35 + 35 (n-2) (n = 2, 3, 4, 5...)
D-C7□ D-C80	5	50	50 + 45 (n-2) (n = 2, 3, 4, 5...)
D-H7□ D-H7□W D-H7BA/H7NF	10	60	60 + 45 (n-2) (n = 2, 3, 4, 5...)
D-C73C/C80C D-H7C	5	65	65 + 50 (n-2) (n = 2, 3, 4, 5...)
D-B5□/B64 D-G5□/K59□	5	75	75 + 55 (n-2) (n = 2, 3, 4, 5...)
D-B59W	10		

Note 1) Auto switch mounting

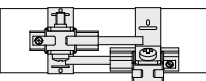
Auto switch model	With 2 auto switches	
	Same surface	
	 <p>The auto switch is mounted by slightly displacing it in a direction (cylinder tube circumferential exterior) so that the auto switch and lead wire do not interfere with each other.</p>	
D-M9□ D-M9□W	Less than 55 stroke ^{Note 2)}	
D-M9□A	Less than 60 stroke ^{Note 2)}	
D-A9□	Less than 50 stroke ^{Note 2)}	

Note 2) Minimum stroke for mounting auto switches in the other mounting types mentioned in note 1.

Operating Range

Auto switch model	Bore size (mm)				
	20	25	32	40	50
D-M9□(V)/M9□W(V) D-M9□A	4.5	5	4.5	5.5	5
D-A9□	7	6	8	8	8
D-C7□/C80 D-C73C/C80C	8	10	9	10	10
D-B5□/B64	8	10	9	10	10
D-B59W	13	13	14	14	14

Auto switch model	Bore size (mm)				
	20	25	32	40	50
D-H7□/H7□W D-H7BA/H7NF	4	4	4.5	5	6
D-H7C	7	8.5	9	10	9.5
D-G5□/K59 D-G5□W/K59W D-G5NT/G5BA	4	4	4.5	5	6
D-G59F	5	5	5.5	6	7

* Since this is a guideline including hysteresis, not meant to be guaranteed. (Assuming approximately ±30% dispersion) There may be the case to change substantially depending on an ambient environment.

MGJ
JMGPT
MGP
MGPW
MGQ
MGG
MGC
MGF
MGZ
MGT

D-□
-X□

Auto Switch Mounting Bracket: Part No.

Auto switch model	Bore size (mm)				
	20	25	32	40	50
D-M9□(V) D-M9□W(V) D-A9□(V)	BMA3-020 (A set of a, b, c, d)	BMA3-025 (A set of a, b, c, d)	BMA3-032 (A set of a, b, c, d)	BMA3-040 (A set of a, b, c, d)	BMA3-050 (A set of a, b, c, d)
D-M9□A(V) ^{Note 2)}	BMA3-020S (A set of b, c, d, e)	BMA3-025S (A set of b, c, d, e)	BMA3-032S (A set of b, c, d, e)	BMA3-040S (A set of b, c, d, e)	BMA3-050S (A set of b, c, d, e)

Switch bracket (Resin)
 a Transparent (Nylon) ^{Note 1)}
 e White (PBT)

* Band (c) is mounted so that the projected part is on the internal side (contact side with the tube).

D-C7□/C80 D-C73C/C80C D-H7□ D-H7□W D-H7NF	BMA2-020A (A set of band and screw)	BMA2-025A (A set of band and screw)	BMA2-032A (A set of band and screw)	BMA2-040A (A set of band and screw)	BMA2-050A (A set of band and screw)
D-H7BA	BMA2-020AS (A set of band and screw)	BMA2-025AS (A set of band and screw)	BMA2-032AS (A set of band and screw)	BMA2-040AS (A set of band and screw)	BMA2-050AS (A set of band and screw)
D-B5□/B64 D-B59W D-G5□/K59 D-G5□W/K59W D-G5BA/G59F D-G5NT	BA-01 (A set of band and screw)	BA-02 (A set of band and screw)	BA-32 (A set of band and screw)	BA-04 (A set of band and screw)	BA-05 (A set of band and screw)

Note 1) Since the switch bracket (made from nylon) are affected in an environment where alcohol, chloroform, methylamines, hydrochloric acid or sulfuric acid is splashed over, so it cannot be used. Please contact SMC regarding other chemicals.

Note 2) For the D-M9□A (V) type auto switch, do not install the switch bracket on the indicator light.

Band Mounting Brackets Set Part No.

Set part no.	Contents
BMA2-□□□A(S) * S: Stainless steel screw	<ul style="list-style-type: none"> Auto switch mounting band (c) Auto switch mounting screw (d)
BJ4-1	<ul style="list-style-type: none"> Switch bracket (White/PBT)(e) Switch holder (b)
BJ5-1	<ul style="list-style-type: none"> Switch bracket (Transparent/Nylon)(a) Switch holder (b)

[Stainless Steel Mounting Screw]

The following stainless steel mounting screw kit is available. Use it in accordance with the operating environment.

(Since the auto switch mounting bracket is not included, order it separately.)

BBA3: D-B5/B6/G5/K5 types

Note 3) For details about the BBA3, refer to page 1225.

When the D-G5BA type auto switch is shipped independently, the BBA3 is attached.

Besides the models listed in How to Order, the following auto switches are applicable.

Refer to pages 1119 to 1245 for detailed specifications.

(Please contact SMC for D-B7□/B80, D-B73C/B80C, D-G79/K79, D-K79C.)

Type	Model	Electrical entry	Features
Reed auto switch	D-C73, C76, B53, B73, B76	Grommet (In-line)	—
	D-C80, B80		Without indicator light
	D-H7A1, H7A2, H7B, G59, G5P, K59, G79, K79	Grommet (In-line)	—
Solid state auto switch	D-H7BW, H7NW, H7PW, G59W, G5PW, K59W	Grommet (In-line)	Diagnostic indication (2-color indicator)
	D-H7BA		Water resistant (2-color indicator)
	D-G5NT		With timer

* For solid state auto switches, auto switches with a pre-wired connector are also available. Refer to pages 1192 and 1193 for details.

* Normally closed (NC = b contact) solid state auto switches (D-F9G/F9H types) are also available. Refer to page 1137 for details.



1 With Piping Ports for Grease

Symbol
-X440

This type is equipped with Rc 1/8 piping ports for grease on both sides of the guide body.

How to Order

MGC **Standard How to Order for each series** —X440

With piping port for grease

Specifications

Applicable series	MGC
Bore size (mm)	20, 25, 32, 40, 50
Fluid	Air
Minimum operating pressure	0.15 MPa (Horizontal, No load)
Piston speed	50 to 750 mm/s
Auto switch	Mountable
Specifications other than above	Same as the standard type

Dimensions (Dimensions other than those below are the same as the standard type.)

MGC series

ø20 to ø50

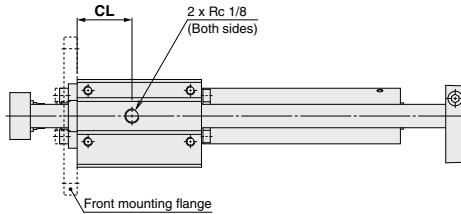

(mm)

Bore size (mm)	CL
20	33
25	35
32	37.5
40	42.5
50	58.5

* The standard grease supply port has a hexagon socket head set screw.

MGJ

JMGP

MGP

MGPW

MGQ

MGG

MGC

MGF

MGT

MGT

D-□

-X□



MGC Series

Specific Product Precautions

Be sure to read this before handling the products.

Refer to back page 50 for Safety Instructions and pages 3 to 12 for Actuator and Auto Switch Precautions.

Installations/Adjustment

Warning

1. Installing a protective cover (In the case of rear plate)

During mounting, handling and operation, the rear plate makes reciprocating movements. Therefore, pay careful attention not to insert your hand, etc., between the cylinder and the rear plate.

When you are going to fit this product to the outside of your equipment, take preventative measures such as installing a protective cover.

MGC Protective cover installation example

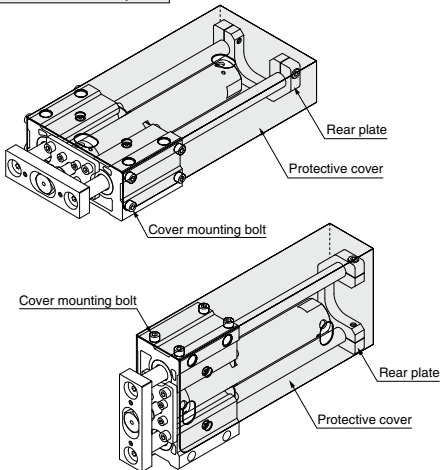

2. Do not open the cushion valve after rotating it numerous times in a row. Though uncommon, there are cases in which the cushion valve may leak air.

The cushion valve should be adjusted by gradually opening it while checking the operation of the cylinder cushion.

Caution

1. Use caution that no scratch or dent will be given to the slide part of the guide rod.

Because the outer circumference of the guide rod is manufactured with precise tolerances, even a slight deformation, scratch, or gouge can lead to faulty operation or reduced durability.

2. When fitting the guide body, use the guide body which has high flatness of the fitting surface.

If the guide rod has twisted, operation resistance will become abnormally higher and the bearing will wear at an early stage, thereby resulting in poor performance.

3. Mount in locations where maintenance will be easy.

Ensure enough clearance around the cylinder to allow for unobstructed maintenance and inspection work.

4. Do not adjust the rod stroke by moving the rear plates,

as doing so will cause the rear plates to come into direct contact with the guide body or the bracket mounting bolt. The resulting impact cannot be absorbed easily, the stroke position cannot be maintained, and faulty operation may result.

5. Lubrication

When you are going to oil the bearings, do so by using a nipple so that no foreign matter will be mixed.

For the grease, we recommended using high-quality lithium soap-based grease no. 2.

6. Mounting orientation (In the case of rear plate)

If the guide body is mounted so that it is inclined more than 90°, the rear plate may interfere with the basic cylinder head end due to the deflection of guide rods. Please consult with SMC.

7. Fixing of base cylinder

When the product is mounted and operated in a location with low rigidity, bending moment may be applied to the base cylinder by vibrations generated at the stroke end, causing damage to the cylinder. In such cases, install a support bracket to suppress the vibration of the body of the base cylinder or reduce the piston speed until the body does not vibrate at the stroke end.