

KP400 SERIES

Features

- 3-color digital LCD display
- Programmable pressure unit :
kPa · MPa · kgf/cm² · bar · psi · inHg · mmHg
- Dual LCD display allows setting value to be displayed
- Key lock indicator
- Analog output : 1~5V or 4~20mA
- Sensor input : 1~5V or 4~20mA
- 12 pressure ranges for transducer

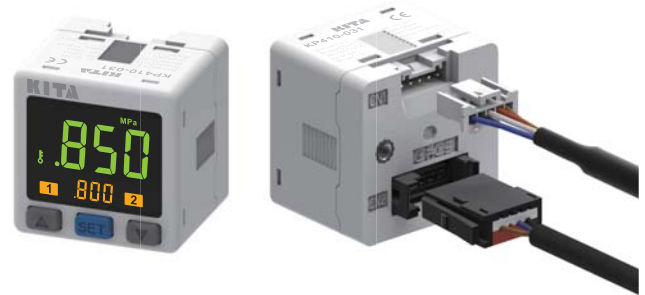

SPECIFICATIONS

MODEL	KP400											
SENSOR TYPE	S-1	S-2	S-3	S-4	S-5	S-6	S-7	S-8	S-9	S-10	S-11	S-12
Rated pressure range	0~-101.3 kPa	0~100 kPa	0~2 kPa	0~5 kPa	-100~100 kPa	-101~500 kPa	0~1 MPa	0~2 MPa	0~2.5 MPa	0~10 MPa	0~25 MPa	0~40 MPa
Setting pressure range	10~-101.3 kPa	-10~100 kPa	-0.2~2 kPa	-0.5~5 kPa	-100~100 kPa	-101~500 kPa	-0.100~1 MPa	-0.100~2 MPa	-0.100~2.5 MPa	0~10 MPa	0~25 MPa	0~40 MPa
Setting pressure range (Auto-shift input)	101.3~-101.3 kPa	-100~100 kPa	-2~2 kPa	-5~5 kPa	-100~100 kPa	-500~500 kPa	-1~-1 MPa	-2~2 MPa	-2.5~2.5 MPa	-10~10 MPa	-25~25 MPa	-40~40 MPa

FEATURES HIGHLIGHT

1 3-color digital LCD display

Main display color change with output status
Green <-> Red
Red <-> Green

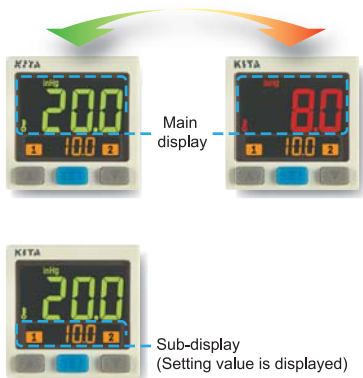

2 Programmable pressure unit

- User selectable pressure unit is indicated on the sub-display section, eliminate pressure unit label
- 7 user programmable pressure units available



3 Save installation space

Panel opening for multiple pressure switches

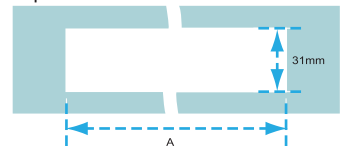

Calculation factor (A) = (34.4 x n) - 3.4
n = number of switches

Actual dimension after installation



4 Key lock function

Key lock icon is shown on the display when the function is enabled.

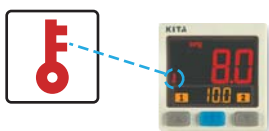

5 12 pressure ranges for transducer

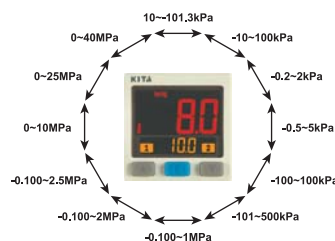

6 Analog output / Sensor input

Current output or voltage output is available

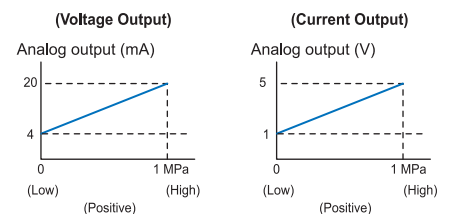

■ SPECIFICATIONS

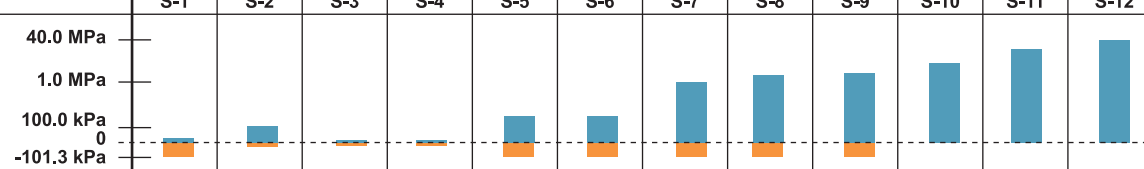
MODEL		KP400											
SENSOR TYPE		S-1	S-2	S-3	S-4	S-5	S-6	S-7	S-8	S-9	S-10	S-11	S-12
													
Rated pressure range		0~-101.3 kPa	0~100 kPa	0~2 kPa	0~5 kPa	-100~100 kPa	-101~500 kPa	0~1 MPa	0~2 MPa	0~2.5 MPa	0~10 MPa	0~25 MPa	0~40 MPa
Setting pressure range		10~-101.3 kPa	-10~100 kPa	-0.2~2 kPa	-0.5~5 kPa	-100~100 kPa	-101~500 kPa	-0.100~1 MPa	-0.100~2 MPa	-0.100~2.5 MPa	0~10 MPa	0~25 MPa	0~40 MPa
Setting pressure range (Auto-shift input)		101.3~-101.3 kPa	-100~100 kPa	-2~2 kPa	-5~5 kPa	-100~100 kPa	-500~500 kPa	-1~1 MPa	-2~2 MPa	-2.5~2.5 MPa	-10~10 MPa	-25~25 MPa	-40~40 MPa
Set pressure resolution	kPa	0.1	0.1	0.01	0.01	0.1	1	-	-	-	-	-	-
	MPa	-	-	-	-	-	-	0.001	0.01	0.01	0.01	0.1	0.1
	kgf/cm ²	0.001	0.001	-	-	0.001	0.01	0.01	0.1	0.1	0.1	1	1
	bar	0.001	0.001	-	-	0.001	0.01	0.01	0.1	0.1	0.1	1	1
	psi	0.01	0.01	-	-	0.01	0.1	0.1	1	1	1	1 (*4)	1 (*4)
	mmHg	1	-	0.1	0.1	1	-	-	-	-	-	-	-
Power supply voltage		12 to 24V DC $\pm 10\%$, Ripple (P-P) 10% or less											
Current consumption		$\leq 40\text{mA}$ (With no load)											
Sensor input		1~5V or 4~20mA											
Switch output		NPN : open collector 2 outputs Max. load current : 125mA Max. supply voltage : 30V DC Residual voltage : $\leq 1.5\text{V}$						PNP : open collector 2 outputs Max. load current : 125mA Max. supply voltage : 24V DC Residual voltage : $\leq 1.5\text{V}$					
Repeatability(Switch output)		$\pm 0.1\%$ F.S. ± 1 digit											
Hysteresis	One point set mode	Adjustable (*1)											
	Hysteresis mode												
	Window comparator mode												
Response time		$\leq 2.5\text{ms}$ (chattering-proof function : 25ms, 100ms, 250ms, 500ms, 1000ms and 1500ms selectable)											
Output short circuit protection		Yes											
7 segment LCD display		Two color (Red/Green) main & unit display, Orange sub-display (Sampling rate : 5 times/1sec.)											
Indicator accuracy		$\pm 1\%$ F.S. ± 1 digit (Ambient temperature: 25 $\pm 3^\circ\text{C}$)											
Switch ON Indicator		Orange (1 & 2 Indicator) OUT1 OUT2											
Analog output (Voltage Output) (*2)		Output Voltage : 1 to 5V $\pm 2.5\%$ F.S. (within rated pressure range) Linearity : $\pm 1\%$ F.S. Output impedance : about 1k Ω											
Analog output (Current Output) (*3)		Output Current : 4 to 20mA $\pm 2.5\%$ F.S. (within rated pressure range) Linearity : $\pm 1\%$ F.S. Max.Load Impedance : 300 Ω at power supply of 12V, 600 Ω at power supply of 24V Min.Load impedance : 50 Ω											
Environment	Enclosure	IP 40											
	Ambient temp. range	Operation : 0 ~ 50 $^\circ\text{C}$, storage : -10 ~ 60 $^\circ\text{C}$ (No condensation or freezing)											
	Ambient humidity range	Operation/Storage : 35 ~ 85% RH (No condensation)											
	Withstand voltage	1000V AC in 1-min (between case and lead wire)											
	Insulation resistance	50M Ω (at 500V DC, between case and lead wire)											
	Vibration	Total amplitude 1.5mm or 10G, 10Hz-55Hz-10Hz scan for 1 minute, two hours each direction of X, Y and Z											
Shock		100m/s ² (10G), 3 times each in direction of X, Y and Z											
Temperature characteristic		$\pm 0.5\%$ F.S. of detected pressure (25 $^\circ\text{C}$) at temp. Range of 0~50 $^\circ\text{C}$											
Lead wire		Oil-resistance cable (0.15mm ²)											
Weight		Approx. 67g (with 2-meter lead wire)											

*1. Hysteresis value is adjustable within 1 ~ 8 digits for one point set mode and window comparator mode.

*2. If analog voltage output is selected, the analog current output cannot be selected at the same time.

*3. If analog current output is selected, the analog voltage output cannot be selected at the same time.

*4. If set pressure unit is psi, the value requires to ten multiply by display value.

KP400 SERIES

■ PANEL DESCRIPTION

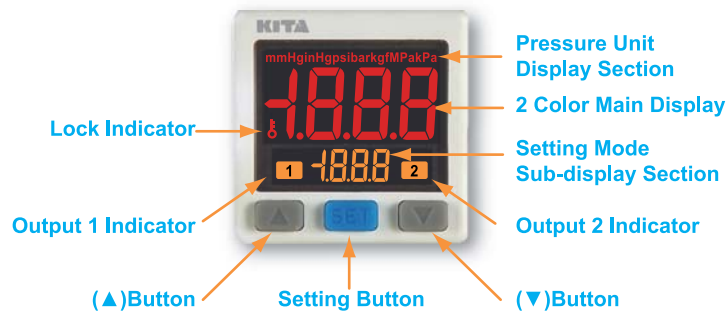

■ OUTPUT CIRCUIT WIRING DIAGRAMS

KP4□0 - 010
2 NPN + Analog Output (1~5V)

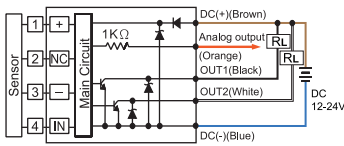

KP4□0 - 030
2 PNP + Analog Output (1~5V)

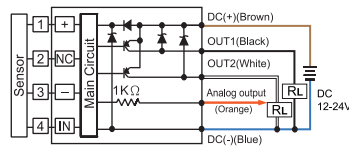

KP4□0 - 05
2 NPN output & Auto-shift input

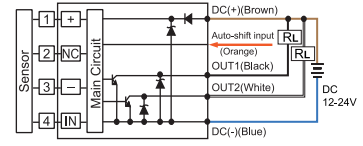

KP4□0 - 011
2 NPN + Analog Output (4~20mA)

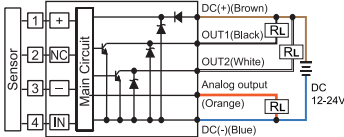

KP4□0 - 031
2 PNP + Analog Output (4~20mA)

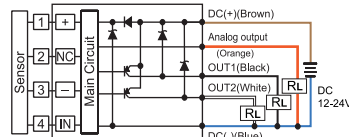

KP4□0 - 07
2 PNP output & Auto-shift input

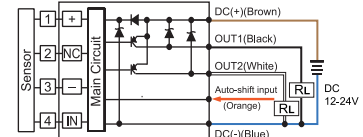

■ ORDERING INFORMATION

K P 4 1 0 - 0 1 0

Input Specifications

- 1 : Voltage input
- 2 : Current input

Output Channel

- 0 : 1 Channel

Standard Part

- CN-0048-01 : Power supply / Output connection cable



Input / Output Specifications

- 010 : 2 NPN outputs & Analog output (1~5V)
- 011 : 2 NPN outputs & Analog output (4~20mA)
- 030 : 2 PNP outputs & Analog output (1~5V)
- 031 : 2 PNP outputs & Analog output (4~20mA)
- 05 : 2 NPN outputs & Auto-shift input
- 07 : 2 PNP outputs & Auto-shift input

Optional Parts

- BT-8 : Mounting bracket
- BT-9 : Mounting bracket
- PA-C : Panel adapter
- PA-D : Panel adapter + Front protective lid
- CN-0046A : Sensor connector $\varnothing 0.8 \sim \varnothing 1.0$ mm, 24~26AWG
- CN-0046B : Sensor connector $\varnothing 1.0 \sim \varnothing 1.2$ mm, 24~26AWG
- CN-0046C : Sensor connector $\varnothing 1.2 \sim \varnothing 1.6$ mm, 24~26AWG
- KP10 □-01 : Transducer

Optional Parts

Mounting bracket



Sensor connector

■ CN-0046□

Transducer



Panel adapter



Panel adapter+Front protective lid



DIMENSIONS

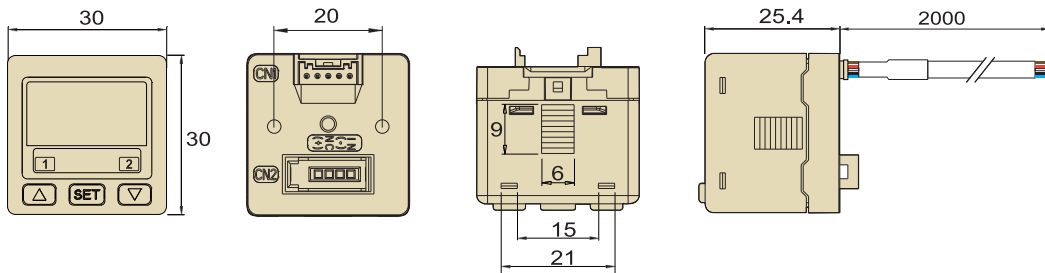

OPTIONAL PARTS DIMENSIONS

1 Mounting Bracket

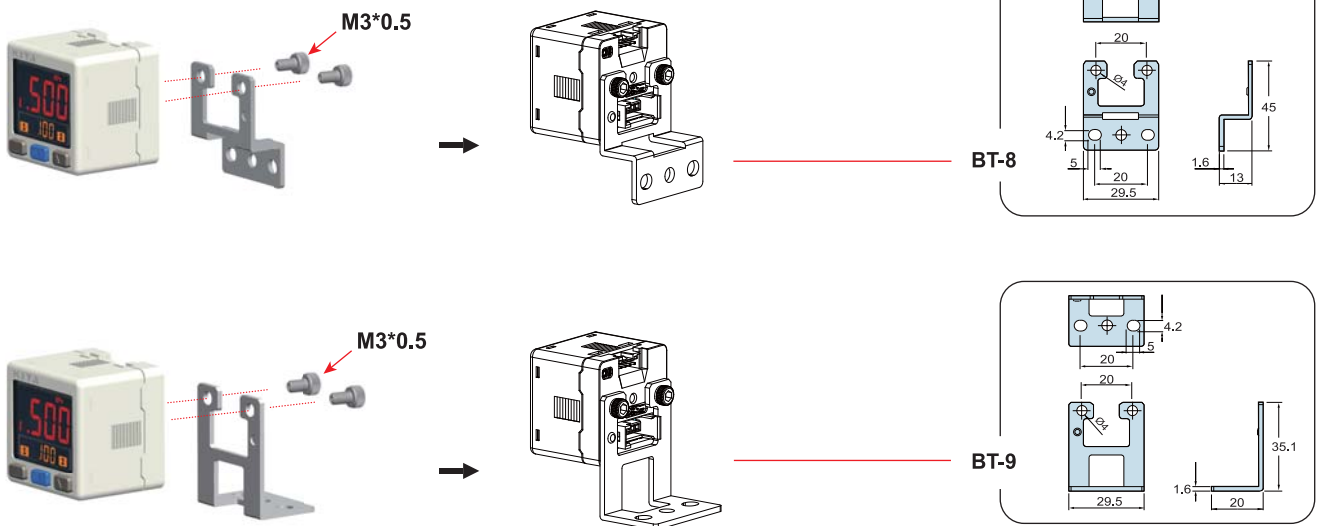

2 Panel Mount Adapter + Front Protective Lid

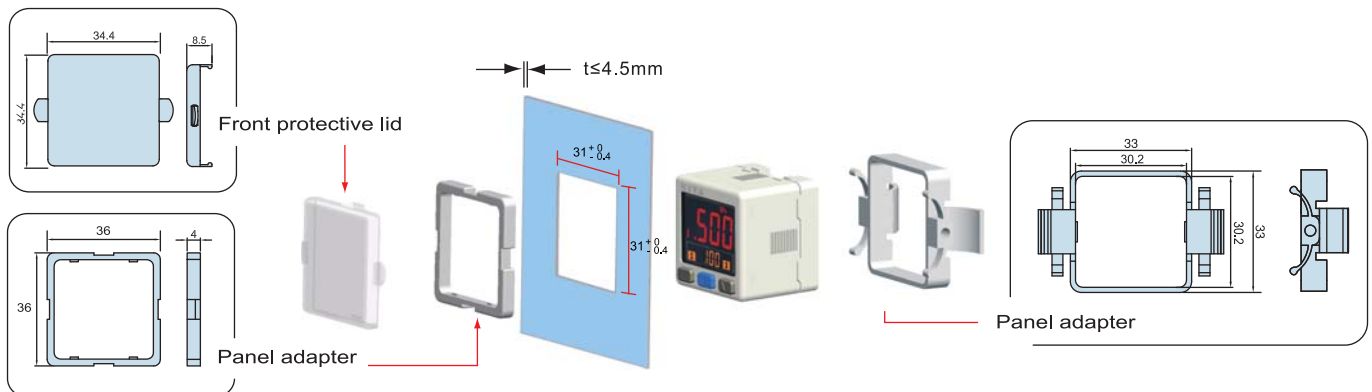

Unit:mm