

G-45 SERIES

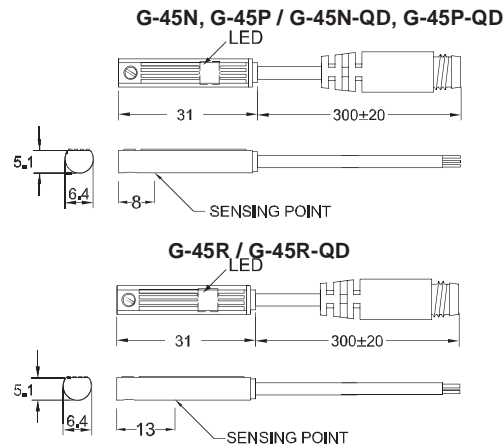

Magnetic switch

■ DIMENSION



Unit:mm

■ QD PINOUT

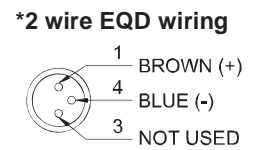
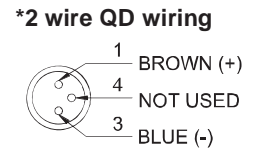
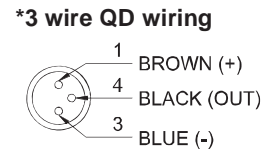

■ SPECIFICATION

TYPE	G -45R	G -45N	G -45P
CONNECT DIAGRAM			
CHARACTERISTICS			
WIRING METHOD	2-Wire Type	3-Wire Type	
SWITCHING LOGIC	SPST, Normally Open	Solid State Output, Normally Open	
SENSOR TYPE	Reed Switch	NPN Current Sinking	PNP Current Sourcing
OPERATING VOLTAGE	5~240V DC/AC	5~30V DC	
SWITCHING CURRENT		100 mA max.	
CONTACT RATING	10 W max.	3 W max.	
CURRENT CONSUMPTION	--	17 mA @ 24V DC max.	14 mA @ 24V DC max.
VOLTAGE DROP	2.5 V @ 50 mA max.	1.5V max.	
LEAKAGE CURRENT	--	0.01 mA max.	
INDICATOR		Red LED	Yellow LED
CABLE	ø2.8, 2C, PUR		ø2.8, 3C, PUR
OPERATING FREQUENCY	200 Hz		1000 Hz
MAGNET REQUIREMENT (NOTE 1)		60 Gauss	
TEMPERATURE RANGE		-10~70°C	
SHOCK (NOTE 2)	30 G		50 G
VIBRATION (NOTE 3)		9 G	
ENCLOSURE CLASSIFICATION		IEC 529 IP 67	
PROTECTION CIRCUIT (NOTE 4)	1		2,3,4

NOTE:

1. Measuring standard target: ø15.5xø8x5t (Anisotropy rubber magnet)
2. Sin wave / X, Y, Z 3 directions / 3 times each direction / 11 ms each time.
3. Double amplitude 1.5 mm / 10Hz~55Hz~10Hz (Sweep 1 min) / X, Y, Z 3 directions / 1 hour each time.
4. 1=None / 2=Short-circuit / 3=Power Source Reverse polarity / 4=Surge Suppression

■ GROOVE DIMENSION

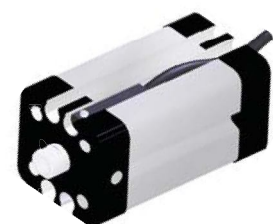
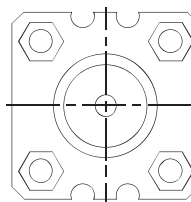
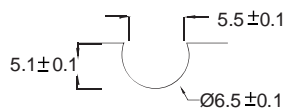
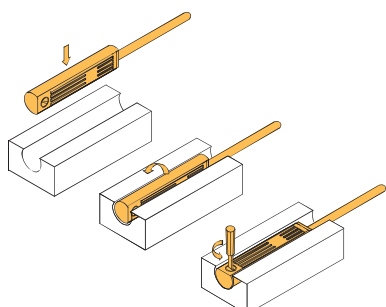

Unit:mm

GENTLE AUTOMATIC SOLUTION SDN BHD

No.36, Jalan Industri USJ 1/13, Taman Perindustrian USJ 1, 47600 Subang Jaya, Selangor.

TEL: 603-8023 7743 / 8743 FAX: 603-8023 9743 email:sales@gentle.com.my / gpauto@tm.net.my